

Owner's Manual  
for Vehicle



The Ultimate  
Driving Machine





## **128i** **Owner's Manual for Vehicle**

**135i** Congratulations, and thank you for choosing a BMW.

Thorough familiarity with your vehicle will provide you with enhanced control and security when you drive it. We therefore have this request:

Please take the time to read this Owner's Manual and familiarize yourself with the information that we have compiled for you before starting off in your new vehicle. It contains important data and instructions intended to assist you in gaining maximum use and satisfaction from your BMW's unique range of technical features. The manual also contains information on maintenance designed to enhance operating safety and contribute to maintaining the value of your BMW throughout an extended service life.

This manual is supplemented by a Service and Warranty Information Booklet for US models or a Warranty and Service Guide Booklet for Canadian models.

We wish you an enjoyable driving experience.

BMW AG

© 2008 Bayerische Motoren Werke  
Aktiengesellschaft  
Munich, Germany  
Reprinting, including excerpts, only with the  
written consent of BMW AG, Munich.  
US English VIII/08  
Printed on environmentally friendly paper,  
bleached without chlorine, suitable for recycling.

# Contents

The fastest way to find information on a particular topic or item is by using the index beginning on page 152.

## Using this Owner's Manual

- 4 Notes
- 6 Reporting safety defects

## At a glance

- 10 Cockpit

## Controls

- 18 Opening and closing
- 35 Adjustments
- 44 Transporting children safely
- 47 Driving
- 56 Everything under control
- 64 Technology for driving comfort and safety
- 74 Lamps
- 79 Climate
- 85 Practical interior accessories

## Driving tips

- 96 Things to remember when driving

## Mobility

- 104 Refueling
- 106 Wheels and tires
- 114 Under the hood
- 118 Maintenance
- 120 Care
- 124 Replacing components
- 130 Giving and receiving assistance
- 134 Indicator and warning lamps

## Reference

- 146 Technical data
- 152 Everything from A to Z

# Notes

## Using this Owner's Manual

We have tried to make all the information in this Owner's Manual easy to find. The fastest way to find specific topics is to refer to the detailed index at the back of the manual. If you wish to gain an initial overview of your vehicle, you will find this in the first chapter.

Should you sell your BMW some day, please remember to hand over the Owner's Manual as well; it is an important component of your vehicle.

### Additional sources of information

Should you have any other questions, your BMW center will be glad to advise you at any time.

Information on BMW, e.g. on technical aspects, can also be found on the Internet at [www.bmwusa.com](http://www.bmwusa.com).

## Symbols used



Indicates precautions that must be followed precisely in order to avoid the possibility of personal injury and serious damage to the vehicle.



Indicates information that will assist you in gaining the optimum benefit from your vehicle and enable you to care more effectively for your vehicle.



Refers to measures that can be taken to help protect the environment.

◀ Marks the end of a specific item of information.

\* Indicates special equipment, country-specific equipment and optional accessories, as well as equipment and functions not yet available at the time of printing.

### Symbols on vehicle components



Indicates that you should consult the relevant section of this Owner's Manual for information on a particular part or assembly.

## The individual vehicle

When you ordered your BMW, you chose various items of equipment. This Owner's Manual describes the entire array of options and equipment available with a specific BMW model.

Please bear in mind that the manual may contain information on accessories and equipment that you have not specified for your own vehicle. Sections describing options and special equipment are marked by asterisks \* to assist you in identifying possible differences between the descriptions in this manual and your own vehicle's equipment.

If equipment in your BMW is not described in this Owner's Manual, please refer to the accompanying Supplementary Owner's Manuals.

## Editorial notice

BMW pursues a policy of continuous, ongoing development that is conceived to ensure that our vehicles continue to embody the highest quality and safety standards combined with advanced, state-of-the-art technology. For this reason, it is possible in exceptional cases that features described in this Owner's Manual could differ from those on your vehicle.

## For your own safety

### Maintenance and repair



Advanced technology, e.g. the use of modern materials and powerful electronics, requires specially adapted maintenance and repair methods. You should therefore have the corresponding work on your vehicle performed only by your BMW center or at a workshop that works according to BMW repair procedures with correspondingly trained personnel. If this work is not carried out properly, there is a danger of subsequent damage and related safety hazards. ◀

### Parts and accessories



For your own safety, use genuine parts and accessories approved by BMW.

When you purchase accessories tested and approved by BMW and Original BMW Parts, you simultaneously acquire the assurance that they have been thoroughly tested by BMW to ensure optimum performance when installed on your vehicle.

BMW warrants these parts to be free from defects in material and workmanship.

BMW will not accept any liability for damage resulting from installation of parts and accessories not approved by BMW.

BMW cannot test every product made by other manufacturers to verify if it can be used on a BMW safely and without risk to either the vehicle, its operation, or its occupants.

Original BMW Parts, BMW Accessories and other products approved by BMW, together with professional advice on using these items, are available from all BMW centers.

Installation and operation of non-BMW approved accessories such as alarms, radios, amplifiers, radar detectors, wheels, suspension components, brake dust shields, telephones, including operation of any mobile phone from within the vehicle without using an externally mounted antenna, or transceiver equipment, for instance, CBs, walkie-talkies, ham radio or similar accessories, may cause extensive damage

to the vehicle, compromise its safety, interfere with the vehicle's electrical system or affect the validity of the BMW Limited Warranty. See your BMW center for additional information. ◀

 Maintenance, replacement, or repair of the emission control devices and systems may be performed by any automotive repair establishment or individual using any certified automotive part. ◀

### California Proposition 65 warning

California law requires us to issue the following warning:

 Engine exhaust and a wide variety of automobile components and parts, including components found in the interior furnishings in a vehicle, contain or emit chemicals known to the State of California to cause cancer and birth defects and reproductive harm. In addition, certain fluids contained in vehicles and certain products of component wear contain or emit chemicals known to the State of California to cause cancer and birth defects or other reproductive harm.

Battery posts, terminals and related accessories contain lead and lead compounds. Wash your hands after handling.

Used engine oil contains chemicals that have caused cancer in laboratory animals. Always protect your skin by washing thoroughly with soap and water. ◀

## Service and warranty

We recommend that you read this publication thoroughly.

Your BMW is covered by the following warranties:

- ▷ New Vehicle Limited Warranty
- ▷ Rust Perforation Limited Warranty
- ▷ Federal Emissions System Defect Warranty
- ▷ Federal Emissions Performance Warranty
- ▷ California Emission Control System Limited Warranty

Detailed information about these warranties is listed in the Service and Warranty Information Booklet for US models or in the Warranty and Service Guide Booklet for Canadian models.

## Reporting safety defects

### For US customers

The following only applies to vehicles owned and operated in the US.

If you believe that your vehicle has a defect which could cause a crash or could cause injury or death, you should immediately inform the National Highway Traffic Safety Administration, NHTSA, in addition to notifying BMW of North America, LLC, P.O. Box 1227, Westwood, New Jersey 07675-1227, Telephone 1-800-831-1117.

If NHTSA receives similar complaints, it may open an investigation, and if it finds that a safety defect exists in a group of vehicles, it may order a recall and remedy campaign. However, NHTSA cannot become involved in individual problems between you, your dealer, or BMW of North America, LLC.

To contact NHTSA, you may call the Vehicle Safety Hotline toll-free at 1-888-327-4236 (TTY: 1-800-424-9153); go to <http://www.safercar.gov>; or write to: Administrator, NHTSA, 400 Seventh Street, SW., Washington, DC 20590. You can also obtain other information about motor vehicle safety from <http://www.safercar.gov>



## For Canadian customers

Canadian customers who wish to report a safety-related defect to Transport Canada, Defect Investigations and Recalls, may call 1-800-333-0510 toll-free from anywhere in Canada or 1-613-993-9851 from the Ottawa region and from other countries, or contact Transport Canada by mail at: Transport Canada, ASFAD, Place de Ville, Tower C, 330 Sparks Street, Ottawa, ON, K1A 0N5.

You can also obtain other information about motor vehicle safety from <http://www.tc.gc.ca>









## At a glance

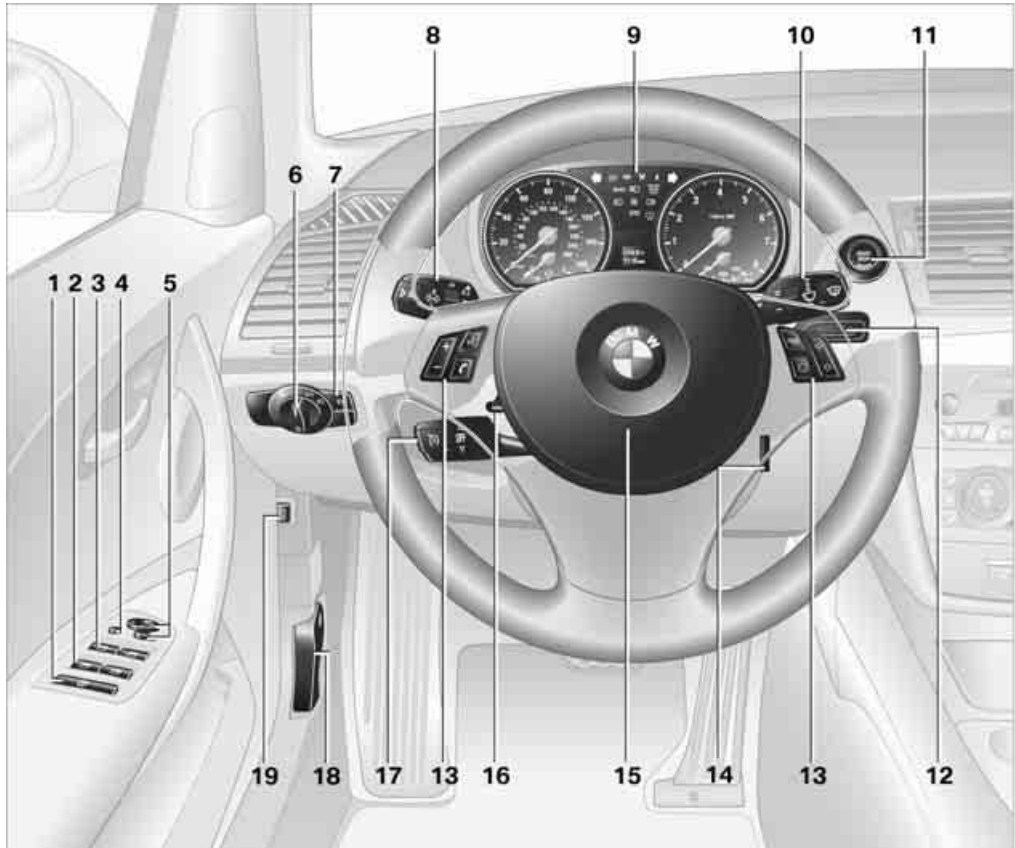



















This overview of buttons, switches and displays is intended to familiarize you with your vehicle's operating environment. The section will also assist you in becoming acquainted with the control concepts and options available for operating the various systems.

# Cockpit

## Around the steering wheel: controls and displays



- |   |   |
|---|---|
| <p>1  Convertible: opening and closing windows jointly 28</p> <p>2  Convertible: opening and closing rear windows 28</p> <p>3  Opening and closing front windows 27</p> <p>4 Folding exterior mirrors in and out* 41</p> <p>5 Adjusting exterior mirrors, automatic curb monitor* 41</p> | <p>6  Parking lamps 74</p> <p> Low beams 74</p> <p> Automatic headlamp control* 74<br/>Adaptive Head Light* 76</p> |
|---|---|

- 7  Fog lamps\* 77
- 8  Turn signals 51
-  High beams, headlamp flasher 76
-  Roadside parking lamps\* 76
-  Computer 57
-  Settings and information about the vehicle 59
-  Settings and information about the vehicle 59
-  Instrument lighting 77
- 9 Instrument cluster 12
- 10  Windshield wipers 52
-  Rain sensor\* 53
- 11  Switching the ignition on/off and starting/stopping the engine 47
- 12 Ignition lock 47
- 13 Buttons on the steering wheel
-  Telephone\*:
- ▷ Press: accepting and ending a call; starting dialing\* of selected phone number; redialing if no phone number is selected.
-  Volume
-  Voice commands for telephone\*
-  Changing radio station
-  Selecting music track
-  Scrolling through phone book and lists with stored phone numbers
-  Next entertainment source
-  Recirculated-air mode 80
- 14  Steering wheel heating\*
- 15 Horn: the entire surface
- 16 Adjusting the steering wheel 43
- 17  Cruise control\* 54
- 18 Releasing the hood 114
- 19 Opening the luggage compartment lid 23

## Instrument cluster

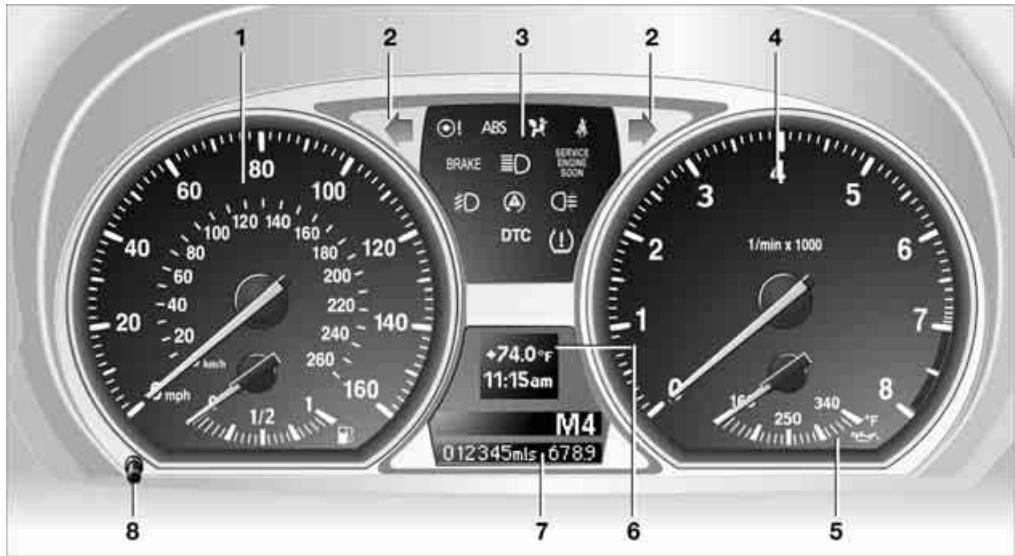

- 1 Speedometer  
135i: with fuel gauge
- 2 Indicator lamps for turn signals
- 3 Indicator and warning lamps 13
- 4 Tachometer 56
- 5 Fuel gauge 57  
135i: engine oil temperature 57
- 6 Display for
  - ▷ Clock 56
  - ▷ Outside temperature 56
  - ▷ Indicator and warning lamps 62
- 7 Display for
  - ▷ Position of automatic transmission\* 49
  - ▷ Computer 57
  - ▷ Date of next scheduled service, and remaining distance to be driven 61
  - ▷ Odometer and trip odometer 56
  - ▷ Initializing the Flat Tire Monitor\* 66
  - ▷ Resetting the Tire Pressure Monitor 68
  - ▷ Checking oil level 115
  - ▷ Settings and information 59
- 8 Resetting the trip odometer 56

# Indicator and warning lamps

## The concept



Indicator and warning lamps in the display area can light up in a variety of combinations and colors.

Some lamps are checked for proper functioning and thus come on briefly when the engine is started or the ignition is switched on.

## What to do in case of a malfunction

A list of all indicator and warning lamps, as well as notes on possible causes of malfunctions and on how to respond, can be found starting on page [134](#).

## Around the center console: controls and displays

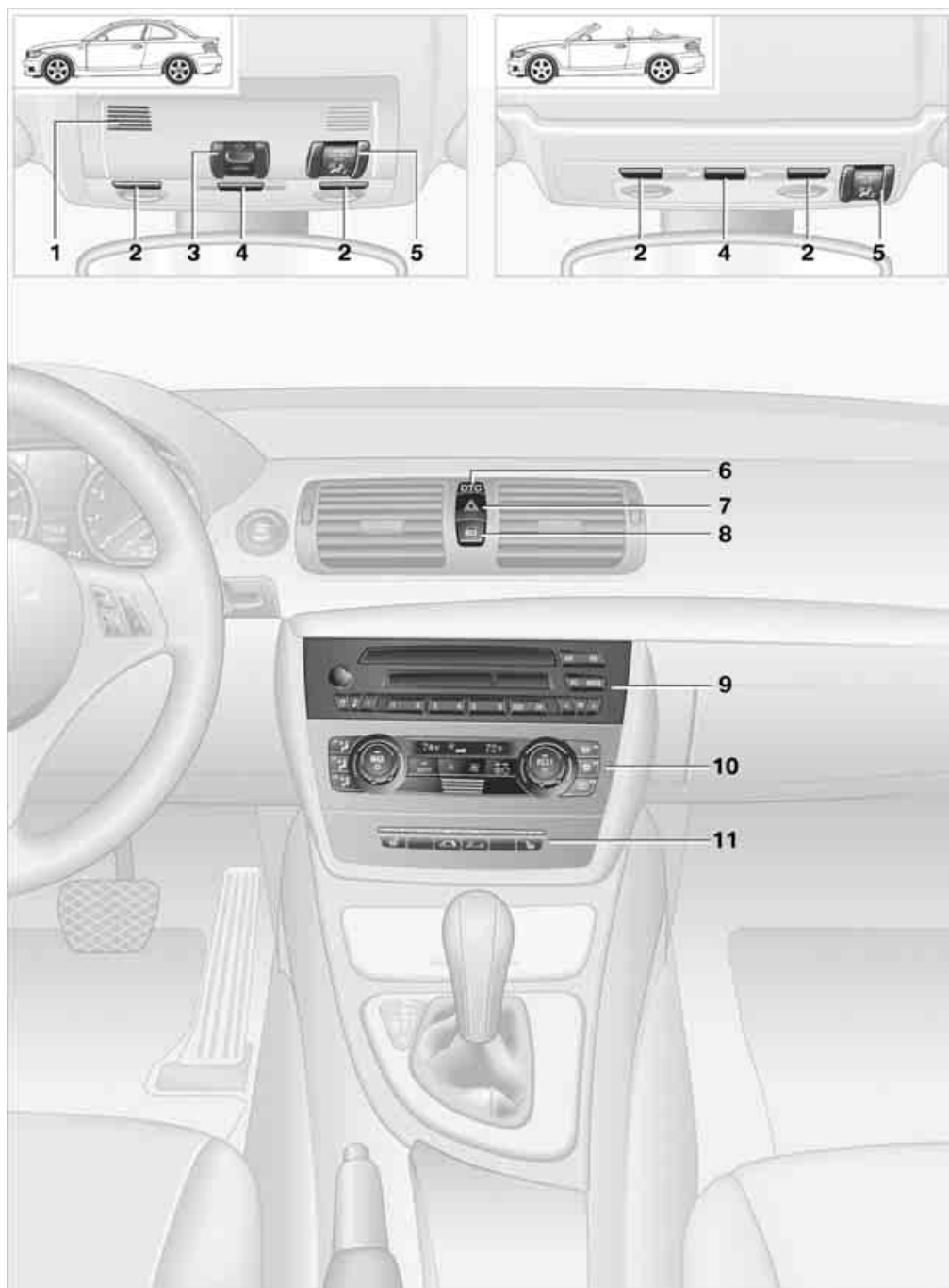



- 1 Coupe: microphone for telephone\* in hands-free mode  
Convertible: microphone on steering column
- 2 Reading lamps\* 78
- 3 Coupe: glass roof, electric\* 29
- 4 Interior lamps 77
- 5 Passenger airbag status lamp 72
- 6 Dynamic Traction Control DTC 65
- 7 Hazard warning flashers
- 8 Central locking system 22
- 9 Radio, refer to separate Owner's Manual
- 10 Heating and ventilation, air conditioner\* or automatic climate control\*



Air distribution for heating 80



Air distribution to the windshield\* 82



Air distribution to the upper body area\* 82



Air distribution to the footwell\* 82

AUTO

Automatic air distribution and flow rate\* 83



Cooling function\* 84



Automatic recirculated-air control AUC\* 83



Recirculated-air mode 80, 83



Maximum cooling\* 82



Residual heat mode\* 83



Air flow rate 80, 83



Defrosting windows\* 84



Rear window defroster 84

11



Heated seats\* 39



Convertible: opening the convertible top 31



Convertible: closing the convertible top 31



A close-up, blue-tinted photograph of a car's interior controls. The image shows a circular dial on the left, a vertical slider or button in the center, and a rectangular control panel on the right. The background is blurred, focusing attention on the controls.

## Controls

This chapter is intended to provide you with information for complete control of your vehicle. All features and accessories that are useful for driving and your safety, comfort and convenience, are described here.

# Opening and closing

## Remote control



Each remote control contains a rechargeable battery that is automatically recharged when it is in the ignition lock while the car is being driven. Use each remote control at least twice a year for longer road trips in order to maintain the batteries' charge status. In cars with convenient access\*, the remote control contains a replaceable battery, refer to page 27.

The settings called up and implemented when the car is unlocked depend on which remote control is used to unlock the car, refer to Personal Profile below.

In addition, information about service requirements is stored in the remote control, refer to Service data in the remote control, page 118.

## Integrated key



Press button 1 to release the key.

The integrated key fits the following locks:

- ▷ Driver's door, refer to page 22
- ▷ Convertible: glove compartment, refer to page 88

## New remote controls

Your BMW center can supply new remote controls with integrated keys as additional units or as replacements in the event of loss.

## Personal Profile

### The concept

You can set many of your BMW's functions to suit your personal needs and preferences. Without any action on your part, Personal Profile ensures that most of these settings are stored for the remote control currently in use. When you unlock the car, the remote control used for the purpose is recognized and the settings stored for it are called up and implemented.

This means that your personal settings will be activated for you, even if in the meantime your car was used by someone else with another remote control and the corresponding settings. The individual settings are stored for a maximum of four remote controls. They are stored for two remote controls if convenient access\* is in use.

## Personal Profile settings

For more information on specific settings, refer to the specified pages.

- ▷ Response of the central locking system when the car is unlocked, refer to page 19
- ▷ Automatic locking of the vehicle, refer to page 22
- ▷ Automatic call-up\* of the driver's seat position after unlocking, refer to page 39
- ▷ Triple turn signal activation, refer to page 52

- ▷ Settings for the display in the instrument cluster:
  - ▷ 12h/24h format of the clock, refer to page 60
  - ▷ Date format, refer to page 60
  - ▷ Units of measure for fuel consumption, distance covered/remaining distances, and temperature, refer to page 60
- ▷ Light settings:
  - ▷ Pathway lighting, refer to page 74
  - ▷ Daytime running lamps, refer to page 75
- ▷ Automatic climate control\*: AUTO program, cooling function and automatic recirculated-air control activation/deactivation, temperature, air flow rate and distribution, refer to page 82
- ▷ Entertainment:
  - ▷ Audio volume, refer to separate Owner's Manual
  - ▷ Speed-dependent volume control, refer to separate Owner's Manual

## Central locking system

### The concept

The central locking system functions when the driver's door is closed.

The system simultaneously engages and releases the locks on the following:

- ▷ Doors
- ▷ Luggage compartment lid
- ▷ Fuel filler door

### Operating from outside

- ▷ Via the remote control
- ▷ Via the door lock\*
- ▷ In cars with convenient access\*, via the handles on the driver's and front passenger's doors

In addition, if the remote control is used, the welcome lamps\*, interior lamps and the door's courtesy lamps\* are switched on or off. The

alarm system\* is also armed or disarmed. For further details on the alarm system\*, refer to page 24.

### Operating from inside

By means of the button for central locking, refer to page 22.

In the event of a sufficiently severe accident, the central locking system unlocks automatically. In addition, the hazard warning flashers and interior lamps come on.

## Opening and closing: Using the remote control



Persons or animals in a parked vehicle could lock the doors from the inside. You should therefore take the remote control with you when you leave the vehicle so that the latter can be opened from outside. ◀

### Unlocking

Press the  button.

The interior lamps, the courtesy lamps\* and the welcome lamps come on.

### Setting unlocking characteristics

You can set whether only the driver's door or the entire vehicle is to be unlocked when the button is pressed for the first time.





For operating principle refer to page 59.

1. Switch on the ignition, refer to page 47.
2. Lightly push button 1 in the turn indicator lever up or down repeatedly until the symbol appears in the display accompanied by the word "SET".



3. Press button 2.
4. Lightly push button 1 in the turn indicator lever down repeatedly until the symbol appears in the display.





5. Press button 2.
6. Use button 1 to select:
  - ▷  Press the  button once to unlock only the driver's door and the fuel filler door. Press the button twice to unlock the entire vehicle.
  - ▷  Press the  button once to unlock the entire vehicle.
7. Press button 2.  
The setting is stored for the remote control currently in use.

### Coupe: convenient opening

Hold the  button down.  
The windows and the glass roof\* are opened.

### Convertible: convenient opening\*

You can open the convertible top using the remote control for convenient access within a range of approx. 13 ft/4 m from the vehicle.

Hold the  button down.  
The windows and the convertible top are opened provided that the doors are closed.  
If you continue pressing the  button, the windows move up.

 Watch during the opening process to ensure that no one is injured. Releasing the button interrupts the opening process. ◀

### Locking

Press the  LOCK button.

### Convertible: convenient closing\*

You can close the convertible top and the windows using the remote control for convenient access within a range of approx. 13 ft/4 m from the vehicle.

Hold the  LOCK button down.  
The convertible top and the windows are closed.

 Watch during the closing process to ensure that no one is injured. Releasing the button interrupts the closing process. ◀

### Switching on interior lamps

While the car is locked:  
Press the  LOCK button.  
You can also use this function to locate your vehicle in parking garages etc.

### Unlocking the luggage compartment lid

Press the  button for a longer period.

The luggage compartment lid opens a short distance, regardless of whether it was locked or unlocked.

 The luggage compartment lid swings backward and up when opened. Ensure that there is sufficient clearance.  
To avoid locking yourself out by accident, do not place the remote control in the cargo bay. A previously locked luggage compartment lid is locked again after closing.  
Before and after each trip, check that the luggage compartment lid has not been inadvertently unlocked. ◀



## Confirmation signals

You can activate or deactivate the confirmation signals.



For operating principle refer to page 59.

1. Switch on the ignition, refer to page 47.
2. Lightly push button **1** in the turn indicator lever up or down repeatedly until the symbol appears in the display accompanied by the word "SET".



3. Press button **2**.
4. Lightly push button **1** in the turn indicator lever down repeatedly until the desired symbol appears in the display.



- ▷  Confirmation signal during unlocking
  - ▷  Confirmation signal during locking
5. Press button **2**.
  6. Use button **1** to select:
    - ▷  The hazard warning flashers light up during unlocking/locking.
    - ▷ **off**  
The function is deactivated.
  7. Press button **2**.  
The setting is stored.

## Malfunctions

The remote control may malfunction due to local radio waves. If this occurs, unlock and lock the car at the door lock with the integrated key.

Coupe: in vehicles without an alarm system\* or convenient access\*, only the driver's door can be unlocked and locked using the integrated key in the door lock.

If the car can no longer be locked with a remote control, the battery in the remote control is discharged. Use the remote control on an extended trip to recharge the battery, refer to page 18. The remote control for convenient access contains a battery that may have to be changed, refer to page 27.

## For US owners only

The transmitter and receiver units comply with part 15 of the FCC/Federal Communications Commission regulations. Operation is governed by the following:

FCC ID:  
LX8766S  
LX8766E  
LX8CAS

Compliance statement:

This device complies with part 15 of the FCC Rules. Operation is subject to the following two conditions:

- ▷ This device must not cause harmful interference, and
- ▷ this device must accept any interference received, including interference that may cause undesired operation.

 Any unauthorized modifications or changes to these devices could void the user's authority to operate this equipment. ◀

## Opening and closing: Using the door lock

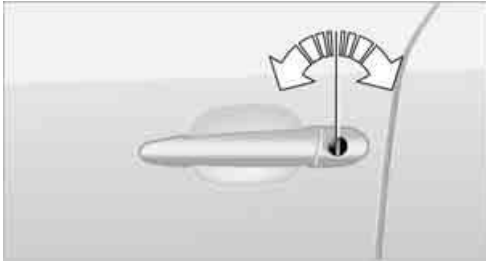

You can set the way in which the car is unlocked, refer to page 19.

### Coupe

 If the vehicle is not equipped with an alarm system\* or convenient access\*, only the driver's door is locked via the door lock. ◀

To lock both doors, the fuel filler door and the luggage compartment lid together:

1. With the doors closed, lock the vehicle using the button for the central locking system in the interior, refer to page 22.
2. Unlock and open the driver's or front passenger's door, refer to page 23.
3. Lock the vehicle.
  - ▷ Lock the driver's door using the integrated key in the door lock, or
  - ▷ press down the lock button of the front passenger's door and close the door from the outside.

### Convenient operation\*

If the car is equipped with an alarm system\* or convenient access\*, you can also control the power windows and the glass roof\* in the coupe or the convertible top in the convertible via the door lock.

Hold the key in the position for unlocking or locking.

 During each closing procedure, and when opening the convertible top, watch the process and ensure that no one becomes

trapped. Releasing the key stops the operation. ◀

### Manual operation

In the event of an electrical malfunction, you can lock and unlock the driver's door by turning the integrated key to the corresponding limit positions in the door lock.

## Opening and closing: From inside



This button serves to unlock or lock doors and the luggage compartment lid, but does not activate the anti-theft system. The fuel filler door remains unlocked.

### Automatic locking

You can also set the situations in which the car locks:

For operating principle refer to page 59.

1. Switch on the ignition, refer to page 47.
2. Lightly push button 1 in the turn indicator lever up or down repeatedly until the symbol appears in the display accompanied by the word "SET".

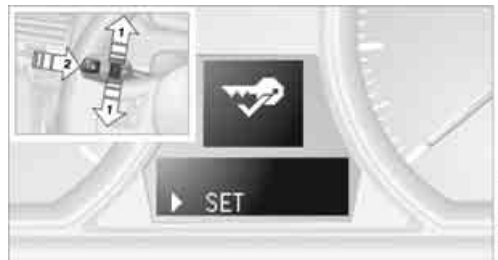

3. Press button 2.



- Lightly push button **1** in the turn indicator lever down repeatedly until the symbol appears in the display.



- Press button **2**.
- Use button **1** to select:
  - on**  
The central locking system automatically locks the vehicle after some time if no door has been opened.
  - on**  
The central locking system automatically locks the vehicle as soon as you drive off.
  - on**  
The central locking system automatically locks the vehicle after some time if no door has been opened, or as soon as you drive off.
  - off**  
The central locking system remains unlocked.
- Press button **2**.  
The setting is stored for the remote control currently in use.

### Unlocking and opening doors

- Either unlock the doors together using the button for the central locking system and then pull the door handle above the armrest or
- pull on the door handle of each door twice: the first time unlocks the door, the second time opens it.

### Locking

- Use the central locking button to lock all of the doors simultaneously, or
- press down the safety lock button of a door. To prevent you from being locked out, the open driver's door cannot be locked using the lock button.

Persons or animals in a parked vehicle could lock the doors from the inside. You should therefore take the remote control with you when you leave the vehicle so that the latter can be opened from outside. ◀

### Luggage compartment lid

In order to avoid damage, make sure there is sufficient clearance before opening the luggage compartment lid. ◀

### Opening from inside



Press the button: the luggage compartment lid opens unless it has been locked.

### Opening from outside



Press the button, see arrow, or the button on the remote control for a longer period. The lug-

gauge compartment lid opens slightly and can be swung upward.

 In the event of a malfunction, please contact your BMW center or a workshop that works according to BMW repair procedures with correspondingly trained personnel. ◀

## Locking or unlocking separately

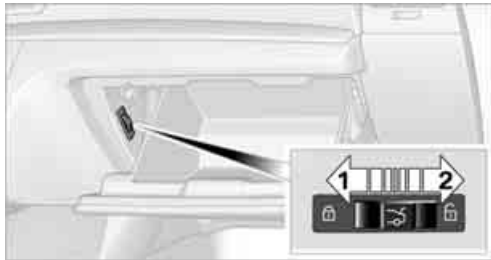

The switch is located in the glove compartment.

- 1 Locking the luggage compartment lid
- 2 Unlocking the luggage compartment lid

## Locking separately

Push the switch in the direction of arrow 1.

The luggage compartment lid is locked and cannot be unlocked using the central locking system.

If you give the remote control without the integrated key to someone else while the glove compartment is locked, the luggage compartment lid cannot be opened. This is an advantage when using valet parking, for example. Locking the glove compartment, refer to page 88.

## Unlocking separately

Push the switch in the direction of arrow 2.

## Emergency release



Pull the lever in the cargo bay. The luggage compartment lid is unlocked.

## Closing



The handle recesses on the interior trim of the luggage compartment lid make it easier to pull down.

 Make sure that the closing path of the luggage compartment lid is clear, otherwise injuries may result. ◀

## Alarm system\*

### The concept

The vehicle alarm system responds:

- ▷ When a door, the hood or the luggage compartment lid is opened
- ▷ To movements inside the vehicle: interior motion sensor, refer to page 25
- ▷ When the car's inclination changes, for instance if an attempt is made to jack it up and steal the wheels or to raise it prior to towing away: tilt alarm sensor, refer to page 25

- ▷ When there is an interruption in the power supply from the battery.

Depending on the national-market version, the alarm system briefly signals unauthorized entry attempts by:

- ▷ An acoustic alarm
- ▷ Switching on\* the hazard warning flashers

## Arming and disarming

When you lock or unlock the vehicle, either with the remote control or at the door lock, the alarm system is armed or disarmed at the same time.

You can open the luggage compartment lid using the  button of the remote control even if the alarm system is armed, refer to page 20.

The lid is locked and monitored again as soon as it is closed.

## Panic mode

You can trigger the alarm system if you find yourself in a dangerous situation.

Press the  button for at least three seconds.

To switch off the alarm: press any button.

## Switching off an alarm

- ▷ Unlock the car with the remote control, refer to page 19, or
- ▷ insert the remote control all the way into the ignition lock.

## Indicator lamp displays



- ▷ The indicator lamp under the inside rear-view mirror flashes continuously: the system is armed.
- ▷ The indicator lamp flashes after locking: doors, hood or luggage compartment lid are

not properly closed. Even if you do not close the alerted area, the system begins to monitor the remaining areas, and the indicator lamp flashes continuously after approx. 10 seconds. The interior motion sensor and the tilt alarm sensor are not activated.

- ▷ The indicator lamp goes out after unlocking: your vehicle has not been disturbed while you were away.
- ▷ If the indicator lamp flashes after unlocking until the remote control is inserted in the ignition, but for no longer than approx. 5 minutes: your vehicle has been disturbed while you were away.

## Tilt alarm sensor

The tilt of the vehicle is monitored. The alarm system reacts, e.g. to attempts to steal a wheel or tow the vehicle.

## Interior motion sensor

### Coupe

In order for the interior motion sensor to function properly, the windows and glass roof must be completely closed\*.

### Convertible

The interior of the car is monitored up to the height of the seat cushions. Thus the alarm system is activated together with the interior motion sensor even if the convertible top is open. The alarm can be triggered unintentionally by falling objects such as leaves, refer to Avoiding unintentional alarms.

## Avoiding unintentional alarms

The tilt alarm sensor and interior motion sensor may be switched off at the same time. This prevents unintentional alarms, e.g. in the following situations:

- ▷ In duplex garages
- ▷ During transport on car-carrying trains, boats/ships or on a trailer
- ▷ When animals are to remain in the vehicle

## Switching off tilt alarm sensor and interior motion sensor

Press the **LOCK** button on the remote control again as soon as the vehicle is locked.

The indicator lamp lights up briefly and then flashes continuously. The tilt alarm sensor and the interior motion sensor are switched off until the next time the vehicle is unlocked and subsequently locked again.

## Convenient access\*

Convenient access enables you to enter your vehicle without needing to hold the remote control in your hand. All you need to do is wear the remote control close to your body, e.g. in your jacket pocket. The vehicle detects the corresponding remote control within the immediate vicinity or in the passenger compartment.

Convenient access supports the following functions:

- ▷ Unlocking/locking the vehicle
- ▷ Unlocking the luggage compartment lid separately
- ▷ Engine starting
- ▷ Convenient closing

## Functional requirement

- ▷ The vehicle or the luggage compartment lid can only be locked when the vehicle detects that the remote control currently in use is outside of the vehicle.
- ▷ The vehicle cannot be locked or unlocked again until after approx. 2 seconds.
- ▷ The engine can only be started when the vehicle detects that the remote control currently in use is inside the vehicle.

## Comparison to the standard remote control

In general, there is no difference between using convenient access or pressing the buttons on the remote control to carry out the functions mentioned above. You should therefore first

familiarize yourself with the instructions on opening and closing starting on page 18.

Special features regarding the use of convenient access are described below.

 If you notice a brief delay while opening or closing windows, the glass roof or the convertible top, the system is checking whether a remote control is inside the vehicle. Please repeat the opening or closing procedure, if necessary. ◀

## Unlocking

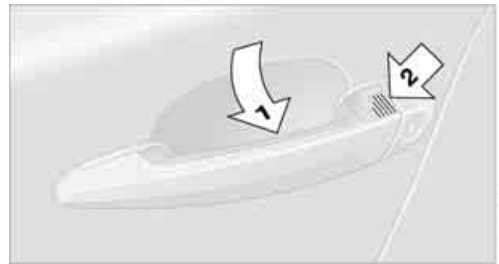

Grasp the handle on the driver's or front passenger's door completely, arrow 1. This corresponds to pressing the **UNLOCK** button.

## Locking

Touch the surface, arrow 2, with your finger for approx. 1 second. This corresponds to pressing the **LOCK** button.

 To preserve the battery, please make sure that the ignition and all electrical consumers are switched off before locking the vehicle. ◀

## Coupe: convenient closing

For convenient closing, keep your finger on the surface, arrow 2.

## Convertible: window and convertible top operation

With the ignition at radio readiness or beyond, you can open and close the windows and the convertible top when a remote control is located inside the vehicle.

## Unlocking the luggage compartment lid separately

Press the button on the outside of the luggage compartment lid. This corresponds to pressing the  button.

 If the vehicle detects that a remote control has been accidentally left inside the locked vehicle after the luggage compartment lid is closed, the lid will reopen. The hazard warning flashers flash and a signal\* sounds. ◀

## Switching on radio readiness

Radio readiness is switched on by pressing the start/stop button, refer to page 47.

 Do not depress the brake or the clutch, otherwise the engine will start immediately. ◀

## Starting the engine

You can start the engine or switch on the ignition when a remote control is inside the vehicle. It is not necessary to insert a remote control into the ignition switch, refer to page 47.

## Switching off the engine in cars with automatic transmission

The engine can only be switched off when the selector lever is in position P, refer to page 48. To switch the engine off when the selector lever is in position N, the remote control must be in the ignition switch.

## Malfunctions

Convenient access may malfunction due to local radio waves. If this happens, open and close the vehicle via the buttons on the remote control or using the integrated key. To start the engine afterward, insert the remote control into the ignition switch.

## Warning lamps

 The warning lamp in the instrument cluster lights up when you attempt to start the engine: the engine cannot be started. The remote control is not inside the vehicle or is malfunctioning. Take the remote control with you inside the vehicle or have it

checked. If necessary, insert another remote control into the ignition switch.



The warning lamp in the instrument cluster lights up while the engine is running: the remote control is no longer inside the vehicle. After the engine is switched off, the engine can only be restarted within approx. 10 seconds.



The indicator lamp in the instrument cluster comes on: replace the battery in the remote control.

## Replacing the battery

The remote control for convenient access contains a battery that will need to be replaced from time to time.

1. Take the integrated key out of the remote control, refer to page 18.



2. Remove the cover.
3. Insert the new battery with the plus side facing up.
4. Press the cover on to close.



Take the old battery to a battery collection point or to your BMW center. ◀

## Windows



To prevent injuries, watch the windows while closing them.

Take the remote control out of the ignition when you leave the car, otherwise children could operate the electric windows and possibly injure themselves. ◀

## Coupe: opening, closing

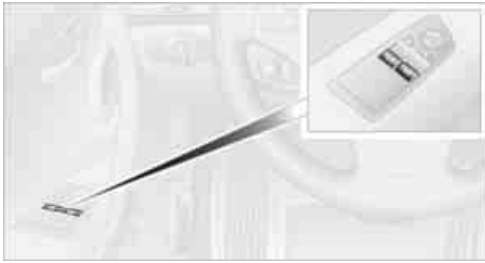

- ▷ Press the switch to the resistance point: The window opens as long as you press the switch.
- ▷ Press the switch beyond the resistance point: The window opens automatically. Press the switch again to stop the opening movement.

You can close the windows in the same manner by pulling the switch.

## Convertible: opening, closing

Window operation with convenient access, refer also to page 20.

**⚠** To close the side windows while driving, either close the rear windows first or all four windows together, otherwise the windows may not close tightly at high speeds. ◀

## Individually



- ▷ Press the switch to the resistance point: The window opens as long as you press the switch.
- ▷ Press the switch beyond the resistance point: The window opens automatically. Press the

switch again to stop the opening movement.

You can close the windows in the same manner by pulling the switch. The rear windows cannot be closed automatically.

## Jointly



- ▷ Press the switch to the resistance point: All windows open as long as you press the switch.
- ▷ Press the switch beyond the resistance point: All windows open automatically. Press the switch again to stop the opening movement.
- ▷ Pull the switch: All windows close as long as you pull the switch.

## After switching off the ignition

When the remote control is removed or the ignition is switched off, you can still operate the windows for approx. 1 minute as long as no door has been opened.

## Convenient operation

For information on convenient operation via the remote control or the door lock, refer to page 19 or 22. For information on closing with convenient access, refer to Locking on page 26.

## Pinch protection system

If the closing force exceeds a specific value as a power window closes, the closing action is interrupted and the window reopens slightly.

**⚠** Despite the pinch protection system check and clear the window's travel path

prior to closing it, otherwise the safety system might fail to detect certain kinds of obstructions, such as thin objects, and the window would continue closing.

Do not install any accessories that might interfere with window movement. Otherwise the pinch protection system could be impaired. Convertible: the rear windows are not equipped with pinch protection. Therefore, watch them closely when closing to avoid personal injury. ◀

### Closing without pinch protection

If there is an external danger, or if ice on the windows, etc., prevents you from closing the windows normally, proceed as follows:

1. Pull the switch past the resistance point and hold it there. Pinch protection is limited and the window reopens slightly if the closing force exceeds a certain value.
2. Pull the switch again past the resistance point within approx. 4 seconds and hold it there. The window closes without pinch protection.

## Coupe: glass roof\*, electric

 To prevent injuries, watch the glass roof while closing it.

Take the remote control with you when you leave the car, otherwise children could operate the roof and possibly injure themselves. ◀



### Raising

Press the switch.

- ▷ The closed glass roof is raised and the sliding visor opens slightly.

- ▷ The open glass roof automatically travels into the raised position. The sliding visor remains completely open.

 Do not close the sliding visor forcibly with the roof in the raised position, as this would damage the mechanism. ◀

### Opening, closing

- ▷ Press the switch backwards to the resistance point.  
The glass roof and the sliding visor open together as long as you hold the switch in this position.
- ▷ Press the switch backwards past the resistance point.  
The glass roof and the sliding visor open automatically. Briefly press the switch again to stop the opening movement.

You can close the glass roof in a similar manner by pressing the switch forwards. The sliding visor remains open and can be closed by hand.

For information on convenient operation via the remote control or the door lock, refer to page 19 or 22. For information on closing with convenient access, refer to Locking on page 26.

### After switching off the ignition

When the remote control is removed or the ignition is switched off, you can still operate the roof for approx. 1 minute as long as no door has been opened.

### Pinch protection system

If the glass roof encounters an obstruction during closing from approximately the middle of the opening in the roof, or during closing from the raised position, the closing movement is interrupted and the glass roof is opened again slightly.

 Despite the pinch protection system check and clear the roof's travel path prior to closing it, otherwise the safety system might fail to detect certain kinds of obstructions, such as very thin objects, and the roof would continue closing. ◀

## Closing without pinch protection

If there is an external danger, press the switch forward past the resistance point and hold it there. The roof closes without pinch protection.

## Following interruptions in electrical power supply

After a power failure, there is a possibility that the glass roof can only be raised. The system must be initialized. BMW recommends having this work done by your BMW center.

## Closing manually\*

In the event of an electrical malfunction, you can move the glass roof manually:

1. Unclip the front of the cover of the interior lamps using the screwdriver from the onboard tool kit, refer to page 124.



2. On both sides, use the screwdriver to press on the clip inside the opening.



3. Remove the control unit.

4. Unplug the motor. Considerably less effort will be required for manual operation.

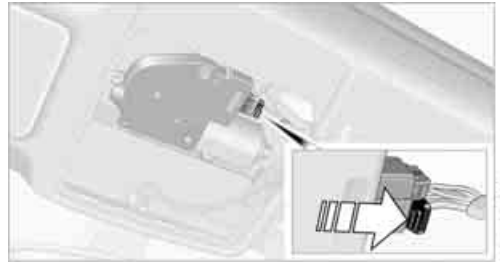

5. Insert the Allen wrench\* supplied with the onboard tool kit, refer to page 124, into the opening provided. Move the glass roof in the desired direction.

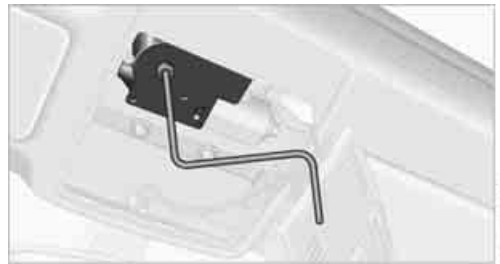

6. Reattach the lamp cover and reinstall the control unit.

## Convertible: top

The fully automatic top combines reliable weather protection with simple and convenient operation.

The following tips will enhance your driving pleasure in your convertible:

- ▷ It is advisable that you close the convertible top when you park the vehicle. Not only does the closed top protect the vehicle interior against unanticipated weather damage, it also offers a certain amount of theft protection. However, even when the top is closed, valuables should only be stored in the locked cargo bay.
- ▷ Do not attach roof-mounted luggage systems to the convertible top.



- ▷ When opening a wet top, e.g. after driving in the rain, water may drip into the cargo bay. If necessary, remove items from the cargo bay beforehand to avoid water stains or soiling.

**⚠** At temperatures below +14 °F / -10 °C, do not move the convertible top as this could result in damage.

Do not keep the convertible top in the convertible top box for longer than one day if it is wet, otherwise the moisture may cause damage. Do not place objects on the convertible top, as otherwise they may fall off when you operate the convertible top and cause damage or injury. Never move the convertible top when the roll-over protection system is in the activated position.

Always fully complete a convertible top movement. Driving with the convertible top incompletely opened or closed can result in damage or injury.

Do not reach into the mechanism during the opening or closing procedure. Keep children away from the opening/closing path of the convertible top.

For safety reasons, only move the convertible top when the vehicle is stationary, if possible. ◀

**⚠** The convertible top swings upward when opening and closing. When operating the convertible top in a garage, under a bridge, etc., ensure that there are at least 6 ft 7 in/2 m of headroom, otherwise the vehicle may be damaged. ◀

### Before opening and closing

- ▷ Comply with the safety precautions described above.
- ▷ Ensure that the cargo bay partition is folded down and engaged on both sides, refer to page 91, otherwise it will not be possible to open the convertible top.
- ▷ Ensure that the cargo does not press against the cargo bay partition from below.
- ▷ Ensure that the luggage compartment lid is closed.

### Opening and closing

Convertible top operation with convenient access, refer also to page 20.

As of radio readiness, refer to page 47:

**▷** If possible, conserve the battery by only operating the convertible top when the engine is running.

Before closing the convertible top, remove all foreign objects from the windshield frame as these could prevent the hardtop from closing properly. ◀

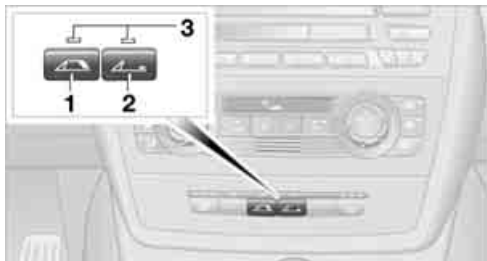

- 1 Push button: close convertible top
- 2 Push button: open convertible top
- 3 LEDs

**▷** The side windows move down when the convertible top is opened. ◀

### Operation while driving

You can open or close the convertible top while driving, as long as the car is not moving faster than approx. 25 mph/40 km/h.

If you accelerate to over 30 mph/50 km/h while the convertible top is moving, the procedure is interrupted.

**⚠** When operating the convertible top while driving, pay extra attention to the traffic to avoid an accident. If possible, do not move the convertible top while driving in reverse gear, because your view to the rear is severely limited during the procedure. Do not operate the convertible top while driving in windy conditions. Do not drive faster than 30 mph/50 km/h, otherwise damage to the vehicle can occur. ◀

## LEDs

- ▷ While the convertible top is being operated, the left LED lights up green. It goes out as soon as the top is fully opened or closed.
- ▷ If the right-hand LED flashes red when you release the button, the opening or closing action has not yet finished.
- ▷ If the right-hand LED lights up red when the button is pressed, the cargo bay partition is raised, the luggage compartment lid is not closed or there is a malfunction. The convertible top cannot be moved.

## Interruption

The automatic sequence of movements is interrupted if the button for the convertible top operation is released. The sequence can be continued in the desired direction by pushing or pulling the buttons.

If the opening or closing procedure is interrupted for an extended period, the convertible top remains in the raised position for approx. 10 minutes and then slowly moves to a stable position.

 A convertible top that is not fully opened or closed is a safety hazard. ◀

 If the convertible top is not fully opened or closed, the luggage compartment lid cannot be opened and the windows cannot be moved. ◀

## Convenient operation with remote control or via door lock

Refer to pages 20 and 22.

## Closing manually

 Only close the convertible top manually if it is absolutely necessary, and never open it manually. The convertible top box cover cannot be locked if there is an electrical defect and would then open while the vehicle is in motion. Incorrect handling can result in damage. ◀

Closing the convertible top manually should be performed by two people. The rear seats must not be occupied.

## Before closing

1. Open the luggage compartment lid.
2. Take the screwdriver out of the onboard tool kit, refer to page 124.



3. If the convertible top lid is locked, release the two buttons in the cargo bay, arrows 1, using the screwdriver and pull them out forcefully as far as they will go. The convertible top box cover is unlocked.
4. Close the luggage compartment lid. After the convertible top box cover is unlocked manually, the luggage compartment lid can no longer be opened.

## Closing

1. Slide the protective cap, arrow 2, forward.
2. Slowly and smoothly open the convertible top box cover all the way, arrow 3.



3. The locking pins must have engaged completely. If they are still visible: close the convertible top box cover as far as necessary until the locking bolts engage audibly, then slowly open the cover. During this process,

do not close the convertible top box cover completely.

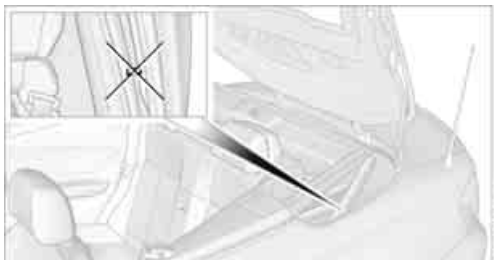

4. Lift out the front part of the convertible top, arrows 4, on both sides and swing it forward. At the same time keep the convertible top box cover from closing, e.g. using your shoulder.

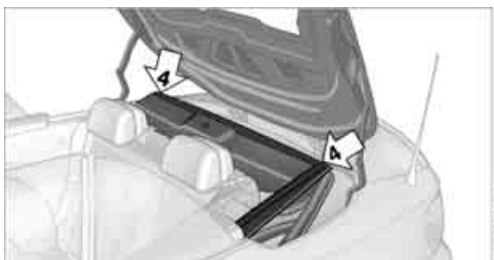

5. Position the rear convertible top frame upright, arrow 5, and close the convertible top box cover, arrow 6. Then lower the rear convertible top frame.

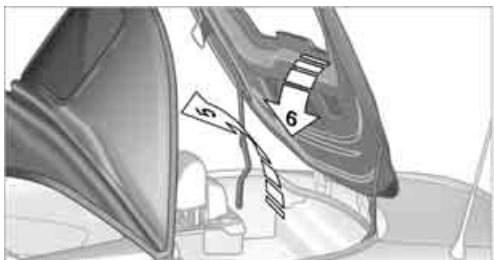

6. Together with another person, press down the front convertible top frame from the outside and on both sides as far as possible.
7. Carefully remove the cover in the center of the front convertible top frame using a pointed object.

8. Attach the handle of the screwdriver to the Allen wrench and insert the wrench into the opening provided.

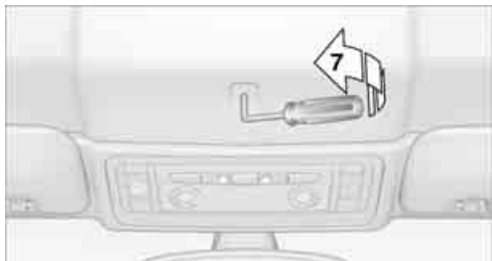

9. Turn the Allen wrench all the way to the left, arrow 7, until the front convertible top frame is locked to the windshield frame. The rear convertible top frame is automatically pressed down onto the convertible top box cover and is sealed tight under tension.

 The closing procedure must be fully completed, otherwise damage or injury may occur. ◀

Please contact your BMW center to have the cause of the malfunction eliminated.

## Wind deflector

The wind deflector keeps air currents in the passenger compartment at a low level when the convertible top is down and provides for an even more pleasant journey at higher speeds.

## Installation

1. Remove the wind deflector from the protective cover and unfold it, arrows 1.

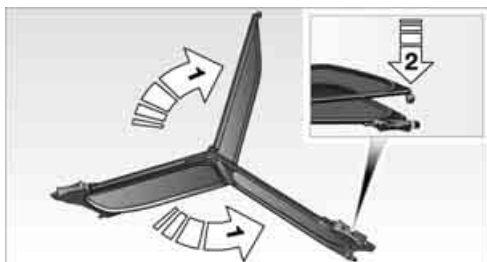

2. Press together the top and bottom parts of the wind deflector until the catch engages, arrow 2.

3. Position both locking pins of one side at the openings provided for them.



4. Press the wind deflector into the openings, arrows **3**, overcoming the tension in the springs, and push the free locking pin in the same direction, arrow **4**.
5. Position the free locking pins at the corresponding openings and let the spring tension lock the wind deflector in place, arrow **5**.



6. Fold up the top section of the wind deflector, arrow **6**.

 With the wind deflector installed: do not recline the front-seat backrests too far if the seat is to be slid all the way back, as this would damage the wind deflector. ◀

## Removing the wind deflector

Proceed in the reverse order as used for installation.

## Folding

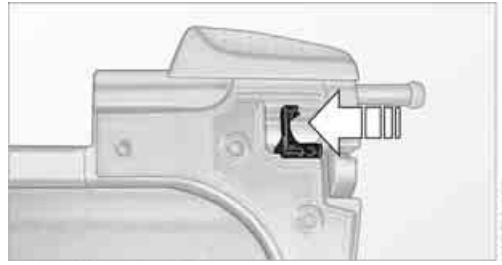

Slide the red release lever towards the middle of the wind deflector and push the two halves apart.

# Adjustments

## Sitting safely

The ideal sitting position can make a vital contribution to relaxed, fatigue-free driving. In conjunction with the safety belts, the head restraints and the airbags, the seated position has a major influence on your safety in the event of an accident. To ensure that the safety systems operate with optimal efficiency, we strongly urge you to observe the instructions contained in the following section.

For additional information on transporting children safely, refer to page 44.

## Airbags

 Always maintain an adequate distance between yourself and the airbags. Always grip the steering wheel on the rim, with your hands in the 3 o'clock and 9 o'clock positions, to minimize the risk of injury to the hands or arms in the event of the airbag being triggered off.

No one and nothing is to come between the airbags and the seat occupant.

Do not use the cover of the front airbag on the front passenger side as a storage area. Make sure that the front passenger is sitting correctly, i.e. not resting feet or legs on the dashboard, otherwise leg injuries can occur if the front airbag is triggered.

Make sure that passengers do not lean their heads against the side or head airbag, otherwise serious injuries could result if the airbags suddenly deployed. ◀

Even if you follow all the instructions, injuries resulting from contact with airbags cannot be fully excluded, depending on the circumstances. The ignition and inflation noise may provoke a mild hearing loss in extremely sensitive individuals. This effect is usually only temporary.

For airbag locations and additional information on airbags, refer to page 71.

## Head restraint

A correctly adjusted head restraint reduces the risk of neck injury in the event of an accident.

 Adjust the head restraint in such a way that its center is at approx. ear level. Otherwise, there is an increased risk of injury in the event of an accident. ◀

Head restraints, refer to page 37.

## Safety belt

Before every drive, make sure that all occupants wear their safety belts. Airbags complement the safety belt as an additional safety device, but they do not represent a substitute.

Your vehicle has four seats, each of which is equipped with a safety belt.

 Never allow more than one person to wear a single safety belt. Never allow infants or small children to ride in a passenger's lap. Make sure that the belt in the lap area sits low across the hips and does not press against the abdomen.

The safety belt must not rest against the throat, run across sharp edges, pass over hard or fragile objects or be pinched. Fasten the safety belt so that it sits as snugly as possible against the lap and shoulder without being twisted. Otherwise the belt could slide over your hips and injure your abdomen in the event of a frontal collision. Avoid wearing bulky clothing and regularly pull the belt in the upper-body area taut, otherwise its restraining effect could be impaired. ◀

Safety belts, refer to page 41.

## Seats

### Note before adjusting

 Never attempt to adjust your seat while the vehicle is moving. The seat could respond with unexpected movement, and the ensuing loss of vehicle control could lead to an

accident.

On the front passenger seat as well, do not incline the backrest too far to the rear while the vehicle is being driven, otherwise there is a danger in the event of an accident of sliding under the safety belt, eliminating the protection normally provided by the belt. ◀

Comply with the instructions on head restraint height on page 37, and on damaged safety belts on page 41.

## Manual adjustment

 Observe the adjustment instructions above to ensure the best possible personal protection. ◀

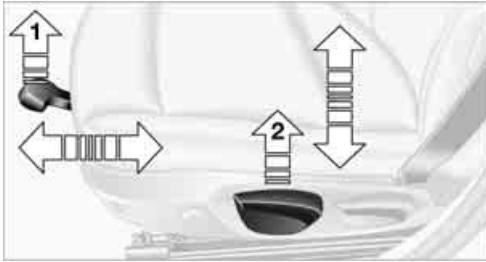

## Longitudinal direction

Pull lever 1 and slide the seat to the desired position.

After releasing the lever, move the seat gently forward or back to make sure it engages properly.

## Height

Pull lever 2 and apply your weight to the seat or lift it off, as necessary.

## Backrest

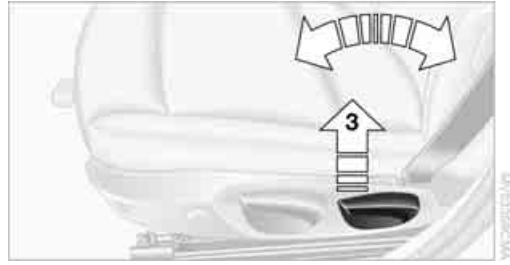

Pull lever 3 and apply your weight to the backrest or lift it off, as necessary.

## Tilt\*



Pull the lever and apply your weight to the seat or lift it off, as necessary.

## Thigh support\*

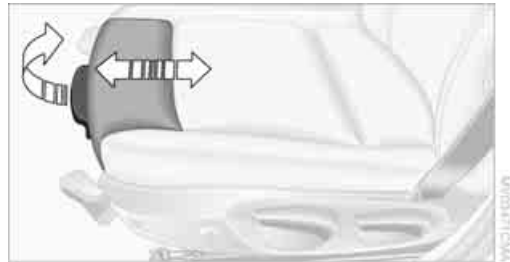

Pull the lever and move the thigh support forward or back.

## Electrical adjustment\*

 Observe the adjustment instructions above to ensure the best possible personal protection. ◀

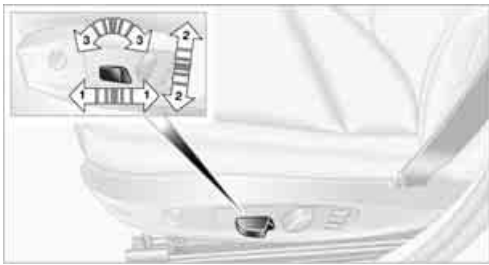

- 1 Longitudinal direction
- 2 Height
- 3 Angle



#### 4 Backrest

The head restraints are adjusted manually, refer to Head restraints on page 37.

#### Lumbar support\*



You can also adjust the contour of the backrest to obtain additional support in the lumbar region.

The upper hips and spinal column receive supplementary support to help you maintain a relaxed, upright sitting position.

- ▷ Increase or decrease curvature: press the switch at the front or rear, respectively.

- ▷ Shift curvature up or down: press the switch at the top or bottom, respectively.

#### Backrest width\*



You can change the width of the backrest to suit your individual preferences by adjusting the lateral-support pads.

Press the front or rear end of the switch. Backrest width decreases or increases accordingly.

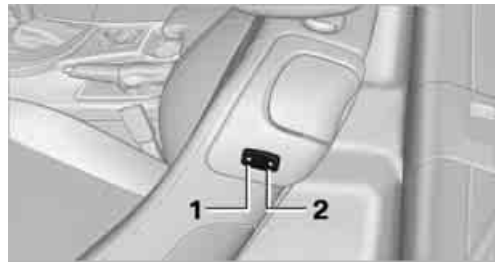

To move the front seats forward or backward from outside or from one of the rear seats: with the door open, press the front end 1 or rear end 2 of the switch.

#### Head restraints

A correctly adjusted head restraint reduces the risk of neck injury in the event of an accident.

- ⚠ Adjust the head restraint in such a way that its center is at approx. ear level. Otherwise, there is an increased risk of injury in the event of an accident. Only remove a head restraint if no one will be sitting on the seat in question. Reinstall the head restraint before transporting anyone on that seat. Otherwise,



the passenger will be without protection from the head restraint. ◀

## Front seats

### Height adjustment



- ▷ To raise: pull up.
- ▷ To lower: press the button, arrow 1, and slide the head restraint down.

### Removing

1. Pull it up as far as it will go.
2. Press the button, arrow 1, and pull the head restraint all the way out.

## Rear seats

### Coupe: height adjustment



- ▷ To raise: pull up.
- ▷ To lower: press the button, arrow 1, and slide the head restraint down.

### Convertible: raising and lowering

- ▷ Only lower the head restraints if there are no passengers in the rear. Raise all lowered head restraints before transporting passengers in the rear. ◀

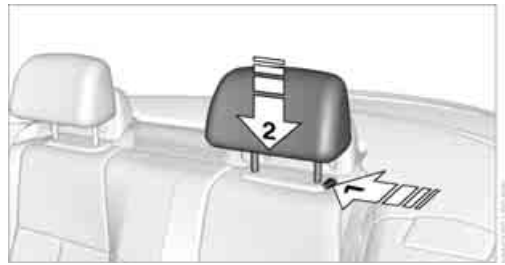

- ▷ To raise: pull up.
- ▷ To lower: press the button, arrow 1, and slide the head restraint down, arrow 2.

### Removing

1. Pull it up as far as it will go.
2. Press the button, arrow 1, and pull the head restraint all the way out.

### Coupe: folding head restraint down and up\*

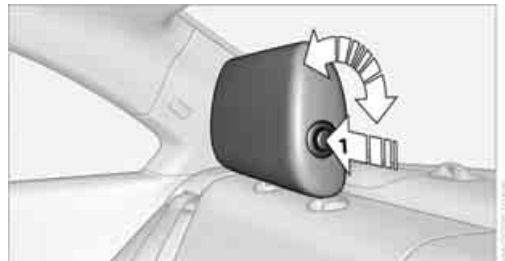

Depending on your vehicle's equipment, it may contain foldable head restraints.

Folding down:

Press the button, arrow 1.

Folding up:

Pull the head restraint.

- ▷ Only fold down the head restraints if there are no passengers in the rear. Fold up the head restraints again before transporting passengers in the rear. ◀



## Seat with manual longitudinal adjustment



### Convenient entry

The convenient entry feature includes a memory function for the longitudinal adjustment and backrest angle.

1. Pull lever **1** and swing the backrest forward.
2. Push the seat forward.

### Previous position

Push the seat backward and swing the backrest back.

 When pushing the seat into its rearmost position, make sure that no one is injured and that no objects are damaged. Before driving off, engage both seats and backrests so that they are locked in place. Otherwise there is a risk of accident due to an unexpected movement. ◀

## Seat with electrical longitudinal adjustment

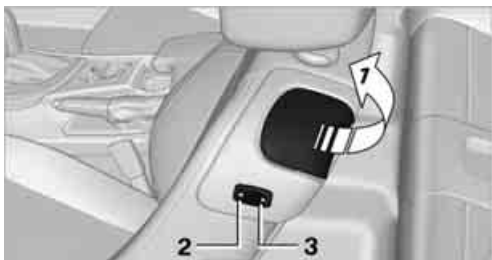

### Convenient entry

The convenient entry feature includes a memory function for the longitudinal adjustment and backrest angle.

1. Pull lever **1** and swing the backrest forward.
2. Press the front end **2** of the switch until the seat has moved into the desired position.

### Previous position

Press the rear end **3** of the switch until the seat automatically stops in its previous position, and fold the backrest back. If you release the switch before the previous seat position is reached, the seat will stop at its current position.

 When sliding the seat backward, make sure no one is injured and no objects are damaged.

Before driving off, engage both seats and backrests so that they are locked in place. Otherwise there is a risk of accident due to an unexpected movement. ◀

## Heated seats\*



Press once for each temperature level. Three LEDs indicate the highest temperature.

To switch off:  
Press button longer.

If you continue driving within approx. 15 minutes, the seat heating is automatically activated at the previously set temperature.

The temperature is lowered or the heating is switched off entirely to save on battery power. The LEDs stay lit.

## Seat and mirror memory\*

You can store and call up two different combinations of driver's-seat and exterior-mirror positions.

Settings for the backrest width and lumbar support are not stored in memory.

## Storing

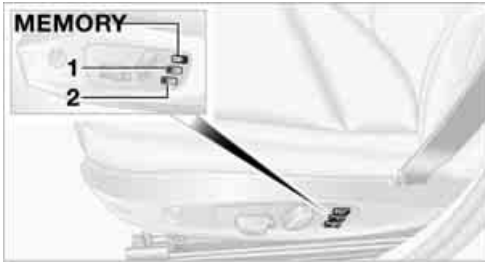

1. Switch on radio readiness or the ignition, refer to page 47.
2. Adjust the seat and exterior mirrors to the desired positions.
3. Press the **M** button. The LED in the button lights up.
4. Press the desired memory button **1** or **2**: the LED goes out.

## Call-up

**⚠** Do not call up memory while you are driving, otherwise unexpected seat movement could result in an accident. ◀

## Convenience mode

1. Unlock and open the driver's door or switch on radio readiness, refer to page 47.
2. Lightly push the desired memory button **1** or **2**.

The adjusting procedure is halted when you touch a seat adjustment switch or one of the memory buttons.

## Safety feature

1. Close the driver's door and switch the ignition on or off, refer to page 47.
2. Press the desired memory button **1** or **2** and keep it pressed until the adjustment process has been completed.

If the **M** button was pressed accidentally: Press the button again; the LED goes out.

## Call-up with the remote control

The driver's seat position last stored is stored for the remote control currently in use.

You can select the occasion on which the seat is reset to that position.

- ▷ Call-up when the vehicle is unlocked.
- ▷ Call-up when the driver's door is opened.

**⚠** When this Personal Profile function is used, first make sure that the footwell behind the driver's seat is free of obstacles. Failure to do so could cause injury to persons or damage to objects as a result of a rearward movement of the seat. ◀

The adjusting procedure is halted when you touch a seat adjustment switch or one of the memory buttons.

## Activating/deactivating automatic call-up

1. Lightly push button **1** in the turn indicator lever up or down repeatedly until the symbol appears in the display accompanied by the word "SET".

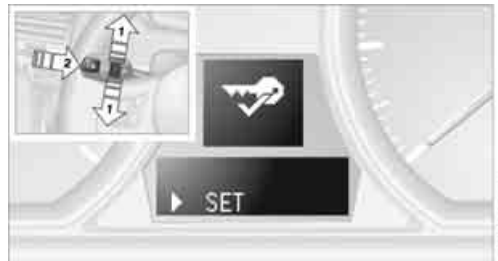

2. Press button **2**.
3. Lightly push button **1** in the turn indicator lever down repeatedly until the symbol appears in the display.



4. Press button 2.
5. Use button 1 to select:
  - ▷ Call-up when the vehicle is unlocked.
  - ▷ Call-up when the driver's door is opened.
  - ▷ **off** Switch off automatic function.
6. Press button 2.  
The setting is stored.

## Safety belts

Observe the adjustment instructions on page 35 to ensure the best possible personal protection. ◀

Before every drive, make sure that all occupants wear their safety belts. Airbags complement the safety belt as an additional safety device, but they do not represent a substitute.



### Closing

Make sure you hear the latch plate engage in the belt buckle.

The upper belt anchor is suitable for adults of any stature as long as the seat is adjusted properly, refer to page 35.

### Opening

1. Grasp the belt firmly.
2. Press the red button in the buckle.
3. Guide the belt into its reel.

### 'Fasten safety belts' reminder for front seats



The indicator lamps come on and an acoustic signal sounds. Check whether the safety belt has been fastened correctly.

The 'Fasten safety belts' reminder is issued as long as the driver's safety belt has not been fastened. The 'Fasten safety belts' reminder is also issued above approx. 5 mph/8 km/h if the front passenger's safety belt has not been fastened, if there are objects on the front passenger's seat or if the driver or front passenger unfasten their safety belts.

### Damage to safety belts

If the safety belts are damaged or stressed in an accident: have the belt system, including any belt tensioners or child-restraint systems, replaced and the belt anchors checked. Have this work done only by your BMW center or at a workshop that works according to BMW repair procedures with correspondingly trained personnel. Otherwise, it is not guaranteed that the safety devices will function properly. ◀

## Mirrors

### Exterior mirrors

The front passenger's mirror is more convex than the driver's mirror. The objects seen in the mirror are closer than they appear. Do not gauge your distance from traffic behind you on the basis of what you see in the mirror; otherwise there is an increased risk of an accident. ◀

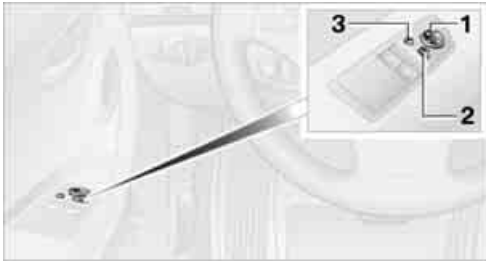

- 1 Adjustments
- 2 Switching to the other mirror or automatic curb monitor\*
- 3 Folding mirrors in and out\*

The setting for the exterior mirrors is stored for the remote control currently in use\*. The stored position is called up automatically when the vehicle is unlocked.

### Manual adjustment

The mirrors can also be adjusted manually: press the edge of the glass.

### Folding mirrors in and out\*

At driving speeds up to approx. 12 mph/ 20 km/h, you can fold the mirrors in and out by pressing button **3**. This can be beneficial in narrow streets, for example, or for moving mirrors that were folded in by hand back out into their correct positions. Mirrors that were folded in are folded out automatically at a speed of approx. 25 mph/40 km/h.

### Automatic heating

Depending on the outside temperature, both exterior mirrors are heated automatically when the engine is running or the ignition is switched on.

## Passenger-side mirror tilt function – automatic curb monitor\*

### Activating

1. Push the switch to the position for the driver's-side mirror, arrow **1**.

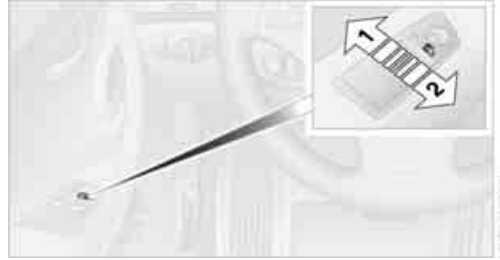

2. Engage reverse gear or move the selector lever to position R.  
The glass of the mirror on the passenger side tilts slightly down. This allows the driver to see the area immediately adjacent to the vehicle, e.g. a curb, when backing into a parking space.

### Deactivating

Push the switch to the position for the passenger-side mirror, arrow **2**.

### Interior rearview mirror



Turn the knob to reduce glare from the headlights of cars behind you when driving at night.

## Interior and exterior mirrors, automatic dimming feature\*

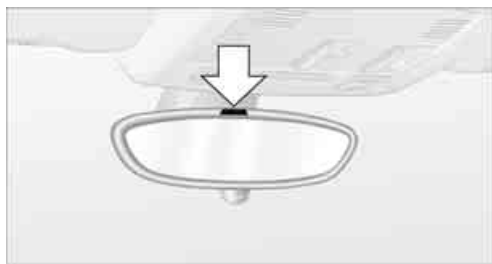

The automatic dimming feature of the interior and exterior mirrors\* is controlled by two photo cells in the interior rearview mirror. One photo cell is in the mirror frame, see arrow; the other is on the back of the mirror.

In order to ensure that the system functions correctly, keep the photo cells clean, do not cover the area between the interior rearview mirror and windshield, and do not affix adhesive labels or stickers of any kind to the windshield directly in front of the mirror.

## Steering wheel

### Adjustments

 Do not adjust the steering wheel position while the car is in motion, otherwise there is a risk of accident due to an unexpected movement. ◀

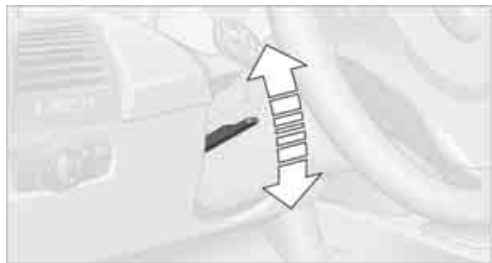

1. Fold the lever down.
2. Move the steering wheel to the preferred height and angle to suit your seated position.
3. Swing the lever back up.

 Do not use force to swing the lever back up, otherwise the mechanism will be damaged. ◀

### Steering wheel heating\*



Press the button.

The LED in the button lights up when the steering wheel heating is switched on.

# Transporting children safely

## The right place for children

**⚠** Do not leave children unattended in the vehicle, otherwise they could endanger themselves and/or other persons by opening the doors, for example. ◀

### Children always in the rear

Accident research has shown that the safest place for children is on the rear seat.

**⚠** Children under the age of 13 or smaller than 5 ft/150 cm may be transported only in the rear in suitable child-restraint systems appropriate for their age, weight and size. Otherwise there is an increased risk of injury in the event of an accident. ◀

Children 13 years of age or older must be buckled in with a safety belt as soon as there no longer is any child-restraint system that is appropriate for their age, size and weight.

### Exception for front passenger seat

**⚠** Should it be necessary to use a child-restraint system on the front passenger seat, the front and side airbags for the front passenger must be deactivated. Otherwise, a child traveling on that seat will face a significant risk of injury if the airbags are triggered off, even with a child-restraint system. ◀

For more information on automatic deactivation of the front passenger airbags refer to page 71.

## Installing child-restraint systems

**⚠** Observe the child-restraint system manufacturer's instructions when selecting, installing and using child-restraint systems. Otherwise the protective effect may be diminished. ◀

Standard child-restraint systems are designed to be secured with a lap belt or with the lap-belt section of a lap-and-shoulder belt. Incorrectly

or improperly installed child-restraint systems can increase the risk of injury to children. Always follow the installation instructions for the system with the greatest care.

### On the front passenger seat

**⚠** After installing a child-restraint system on the front passenger seat, make sure that the front and side airbags for the front passenger are deactivated, otherwise there is an increased risk of injury if the airbags deploy. ◀

### Backrest width\*

**⚠** The backrest width of the front passenger's seat must be at its widest possible setting. Do not change the setting after installing the child seat. Otherwise the child seat's stability on the front passenger's seat is limited. ◀

1. Adjust the backrest width to its widest setting, refer to page 37.
2. Install the child seat.

### Child seat security



The rear safety belts and the front passenger's safety belt can be prevented from being pulled out in order to fasten child-restraint systems.

### To lock the safety belt

1. Secure the child-restraint system with the belt.
2. Pull the belt strap all the way out.

3. Allow the belt strap to retract and pull it taut against the child-restraint system.

The safety belt is locked.

### To unlock the safety belt

1. Open the belt buckle.
2. Remove the child-restraint system.
3. Allow the safety belt strap to retract all the way.

## LATCH child-restraint fixing system

LATCH: Lower Anchors and Tethers for Children.

**!** To install and use the LATCH child restraint system, follow the operating and safety instructions provided by the manufacturer of the system, otherwise the protective function of the seat may be compromised. ◀

Before installing the child seat, pull the belt out of the area for the child-restraint fixing system.

**!** Ensure that both lower LATCH anchors are correctly engaged and that the child restraint system is resting firmly against the backrest, otherwise the protective function of the seat may be compromised. ◀

### Coupe: rear seats



The anchor points for the lower LATCH anchors are located behind the labeled protective caps.

### Convertible: rear seats

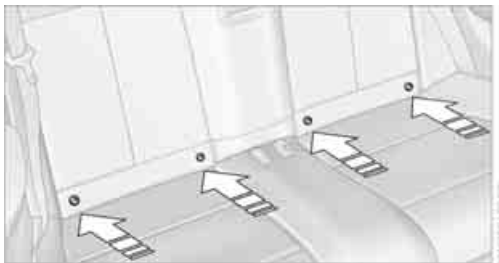

The anchor points for the lower LATCH anchors are located at the positions indicated by arrows, in the gap between the seat and the backrest.

### Coupe: child-restraint system with tether strap

**!** Use the top tether anchors to secure child-restraint systems only, otherwise the anchors could be damaged. ◀

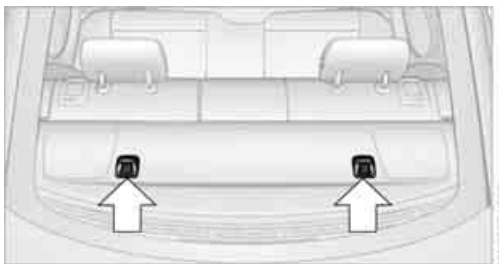

For child-restraint systems with tether straps there are two additional anchors, see arrows.

### Coupe: placement of the tether strap

**!** Make sure the upper retaining strap does not run over sharp edges and is not twisted as it passes to the top anchor. Otherwise the strap will not properly secure the child-restraint system in the event of an accident. ◀

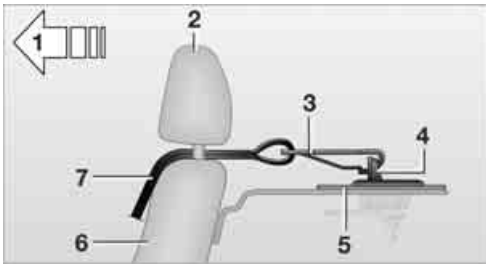

- 1 Direction of travel
- 2 Head restraint
- 3 Hook for upper retaining strap
- 4 Anchor
- 5 Rear window shelf
- 6 Seat backrest
- 7 Upper retaining strap of child-restraint system

If necessary, fold the head restraints upward before use.

1. Push the head restraint upward.
2. Guide the upper retaining strap between the head restraint holders.
3. Use the hook to clip the retaining strap to the anchor.
4. Push the head restraint into its lowermost position.
5. Pull the retaining strap taut.



# Driving

## Ignition lock

### Insert the remote control into the ignition lock

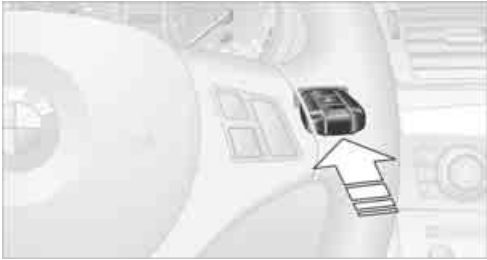

Insert the remote control all the way into the ignition lock.

- ▷ Radio readiness is switched on. Individual electrical consumers can operate.

### Convenient access\*

If the car is equipped with convenient access, only insert the remote control into the ignition lock under special circumstances, refer to page 26.

### Removing the remote control from the ignition lock

 Do not forcibly pull the remote control out of the ignition lock as this may cause damage. ◀

Before removing the remote control, push it all the way in to release the locking mechanism.

- ▷ The ignition is switched off if it was on.

### Automatic transmission

You cannot take out the remote control unless the selector lever is in the P position: interlock.

## Start/stop button

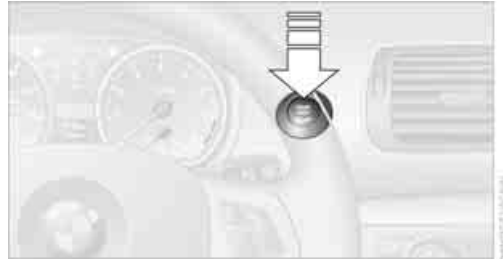

Pressing the start/stop button switches radio readiness or the ignition on or off.

- ▶ The engine is started when you press the start/stop button and depress the clutch if the car has manual transmission, or the brake if the car has automatic transmission. ◀

### Radio readiness

Individual electrical consumers can operate. The time and the outside temperature are displayed in the instrument cluster.

Radio readiness is switched off automatically:

- ▷ When the remote control is removed from the ignition lock
- ▷ In cars with convenient access\*, by touching the surface above the door lock, refer to Locking on page 26

### Ignition on

All electrical consumers can operate. The odometer and trip odometer are displayed in the instrument cluster.

- ▶ When the engine is off, please switch off the ignition and any unnecessary electrical consumers in order to preserve the battery. ◀

### Radio readiness and ignition off

All indicator and warning lamps as well as displays in the instrument cluster go out.

## Starting the engine

 Do not run the engine in closed rooms, otherwise the inhalation of toxic exhaust gases can cause unconsciousness and death. The exhaust gases contain carbon monoxide, an odorless and colorless, but highly toxic gas. Never leave an unattended vehicle with the engine running, otherwise such a vehicle represents a potential safety hazard. Before leaving the car with the engine running, place the transmission in neutral or move the selector lever to position P and forcefully apply the parking brake to prevent the car from moving. ◀

Do not wait for the engine to warm up while the vehicle remains stationary. Start driving right away, but at moderate engine speeds.

 Avoid frequent starting in quick succession as well as repeated start attempts in which the engine does not start. Otherwise, the fuel is not burned or incompletely burned and there is a danger of overheating and damaging the catalytic converter. ◀

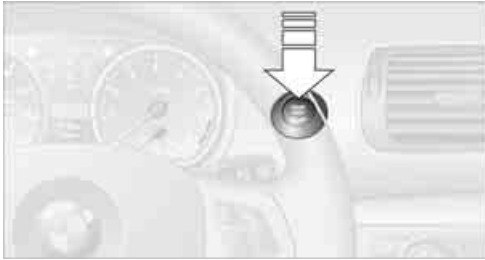

### Manual transmission

Remote control in the ignition lock or, with convenient access, inside the vehicle, refer to page 26.

1. Depress the brake.
2. Depress the clutch and shift to neutral position.
3. Press the start/stop button.

The starter operates automatically for a certain time, and stops automatically as soon as the engine has started.

### Automatic transmission

Remote control in the ignition lock or, with convenient access, inside the vehicle, refer to page 26.

1. Depress the brake.
2. Move the selector lever to position P.
3. Press the start/stop button.

The starter operates automatically for a certain time, and stops automatically as soon as the engine has started.

## Switching off the engine

 Always take the remote control with you when you leave the vehicle. When parking, apply the parking brake forcefully, otherwise the vehicle could begin to roll. ◀

### Manual transmission

1. With the car at a standstill, press the start/stop button.
2. Shift into first gear or reverse.
3. Forcefully apply the parking brake.
4. Removing the remote control from the ignition lock, refer to page 47.

### Automatic transmission

1. With the car at a standstill, move the selector lever to position P.
2. Press the start/stop button.
3. Forcefully apply the parking brake.
4. Removing the remote control from the ignition lock, refer to page 47.

### Before driving into a car wash

The vehicle is able to roll if you take the following steps:

1. Insert the remote control, even with convenient access, into the ignition lock.
2. Depress the brake.
3. Move the selector lever to position N.
4. Switch off the engine.

## Parking brake

The parking brake is primarily intended to prevent the vehicle from rolling while parked; it brakes the rear wheels.

### Indicator lamp



The indicator lamp is lit, and when you drive off a signal sounds in addition. The parking brake is still applied.



Indicator lamp for Canadian models.

### Applying

The lever locks in position automatically.

### Releasing



Pull slightly upwards, press the button and lower the lever.

In exceptional cases, if the parking brake has to be used to slow or stop the car, do not pull the lever up too hard. In doing so, continuously press the button of the parking brake lever.

Otherwise, excessive force on the parking brake can lock up the rear wheels and cause the rear of the car to swerve. ◀

To prevent corrosion and one-sided braking action, occasionally apply the parking brake lightly when the vehicle is slowly coming to a stop if the traffic conditions are suitable. The brake lamps do not light up when the parking brake is applied. ◀

## Manual transmission



When shifting into 5th or 6th gear, press the gearshift lever to the right. Otherwise the engine could be damaged if you inadvertently shift into 3rd or 4th gear. ◀

### Reverse gear

Select this only when the vehicle is stationary. When the gearshift lever is pressed to the left, a slight resistance has to be overcome.

## Automatic transmission with Steptronic\*

In addition to fully automatic operation, you can also manually shift with the Steptronic, refer to page 50.

### Vehicle parking

To prevent the vehicle from rolling, always select position P and apply the parking brake before leaving the vehicle with the engine running. ◀

### Disengaging the remote control

In order to remove the remote control from the ignition lock, you must first move the selector lever to position P and switch off the engine: interlock. Removing the remote control from the ignition lock, refer to page 47.

### Selector lever positions

P R N D M/S + -

## Displays in the instrument cluster



P R N D S M1 to M6

The selector lever position is displayed, or the current gear in the manual mode.

## Changing selector lever positions

- ▷ With the ignition switched on or the engine running, the selector lever can be moved out of position P: interlock.
- ▷ Before moving the lever away from P or N with the vehicle stationary, first depress the brake; otherwise the selector lever will refuse to move: shiftlock.



To prevent the vehicle from creeping after you select a driving position, depress the brake until you are ready to start. ◀



A lock prevents you from inadvertently engaging selector lever positions R and P. To cancel the lock, press the button on the front of the selector lever, see arrow.

## P Park

Select this only when the vehicle is stationary. The drive wheels are locked.

## R Reverse

Select this only when the vehicle is stationary.

## N Neutral

You can select this in a car wash, for example. The vehicle can roll.

## D Drive, automatic position

Position for normal vehicle operation. All forward gears are selected automatically.

Under normal operating conditions, fuel consumption is lowest when you are driving in position D.

## Kick-down

Kick-down enables you to achieve maximum performance.

Press the accelerator pedal beyond the full-throttle resistance point.

## Sport program and manual operation M/S



Move selector lever from position D toward the left into the M/S shifting slot:

The sport program is activated and DS is displayed on the instrument cluster. This position is recommended for a performance-oriented driving style.

To use the automatic mode again, move the selector lever to the right into position D.

## Shifting gears via the selector lever

When you press the selector lever forwards or backwards, the manual mode is activated and Steptronic changes gear. M1 through M6 are displayed on the instrument cluster.

Upshifts and downshifts are executed only when they will result in a plausible combination of engine and vehicle speed; thus, for example, a downshift that would cause the engine to overrev will not be executed by the system. The gear selected is briefly displayed in the instrument cluster, followed by the gear actually in use.

### Shifting gears via shift paddles\* on the steering wheel

The shift paddles allow you to shift gears quickly since both hands can remain on the steering wheel.

- ▶ When you use the shift paddles on the steering wheel to shift gears in automatic mode, the transmission switches to manual mode.
- ▶ If you do not accelerate or shift gears using the shift paddles for a certain amount of time, the transmission switches back to automatic mode.

▶ If the selector lever is in the M/S gear plane, manual mode remains active. ◀

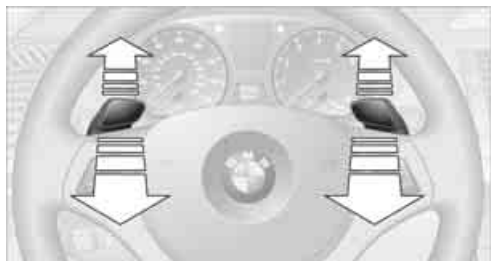

- ▶ To shift up: pull one of the shift paddles.
- ▶ To shift down: press one of the shift paddles.

Upshifts and downshifts are executed only when they will result in a plausible combination of engine and vehicle speed; thus, for example, a downshift that would cause the engine to overrev will not be executed by the system. The gear selected is briefly displayed in the instrument cluster, followed by the gear actually in use.

### Overriding selector lever lock

Should the selector lever refuse to move out of position P although the button on the selector lever is pressed, the selector lever lock can be overridden:

1. Unclip the sleeve of the selector lever.
2. Pull the sleeve up over the selector lever until the sleeve is inside out.

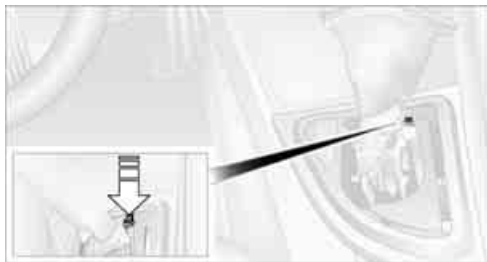

3. Using the screwdriver from the onboard tool kit, refer to page 124, press the red lever, see arrow, while moving the selector lever to the desired position.

### Turn signals/ headlamp flasher

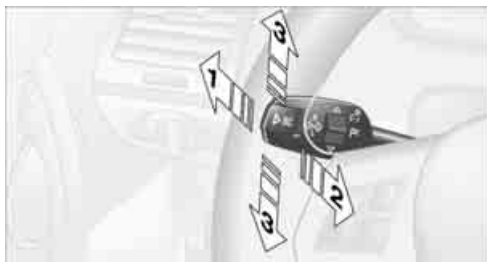

- 1 High beams
- 2 Headlamp flasher
- 3 Turn signals

### Using turn signals

Press the lever beyond the resistance point.

To turn off manually, press the lever to the resistance point.

 Unusually rapid flashing of the indicator lamp and the turn signals indicates that one of the turn signal bulbs has failed. ◀

## Indicating a turn briefly

Press the lever as far as the resistance point for as long as you wish to indicate a turn.

## Triple turn signal activation

Press the lever as far as the resistance point. The turn signals flash three times.

You can activate or deactivate this function:

1. Switch on the ignition, refer to page 47.
2. Lightly push button 1 in the turn indicator lever up or down repeatedly until the symbol appears in the display accompanied by the word "SET".



3. Press button 2.
4. Lightly push button 1 in the turn indicator lever down repeatedly until the symbol appears in the display.



5. Press button 2.

6. Use button 1 to select:
  - ▷ 1 x  
Turn signals flash once.
  - ▷ 3 x  
Triple turn signal.
7. Press button 2.  
The setting is stored for the remote control currently in use.

## Wiper system

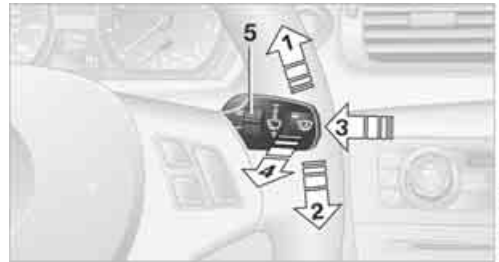

- 1 Switching on wipers
- 2 Switching off wipers or brief wipe
- 3 Activating/deactivating intermittent wipe or rain sensor\*
- 4 Cleaning windshield and headlamps\*
- 5 Setting speed for intermittent wipe, or sensitivity of the rain sensor

## Switching on wipers

Press the lever upward, arrow 1.

The lever automatically returns to its initial position when released.

## Normal wiper speed

Press once.

The system switches to operation in the intermittent mode when the vehicle is stationary.

## Fast wiper speed

Press twice or press beyond the resistance point.

The system switches to normal speed when the vehicle is stationary.

## Intermittent wipe or rain sensor\*

If the car is not equipped with a rain sensor, the intermittent-wipe time is a preset.

If the car is equipped with a rain sensor, the time between wipes is controlled automatically and depends on the intensity of the rainfall. The rain sensor is mounted on the windshield, directly in front of the interior rearview mirror.

## Activating intermittent wipe or rain sensor

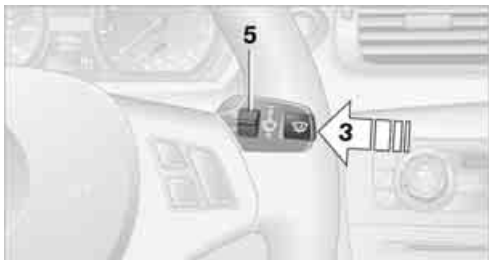

Press the button, arrow **3**. The LED in the button lights up.

## Setting speed for intermittent wipe or sensitivity of the rain sensor

Turn the thumb wheel **5**.

## Deactivating intermittent wipe or rain sensor

Press the button again, arrow **3**. The LED goes out.

 Deactivate the rain sensor before entering an automatic car wash. Failure to do so could result in damage caused by undesired wiper activation. ◀

## Cleaning windshield and headlamps\*

Pull the lever, arrow **4**.

Washer fluid is sprayed onto the windshield and the wipers are operated for a short time.

When the vehicle lighting system is switched on, the headlamps are cleaned at regular and appropriate intervals.

 Do not use the washers if there is any danger that the fluid will freeze on the windshield. If you do, your vision could be

obscured. Antifreeze should therefore be added to the fluid, refer to Washer fluid. Do not use the washers when the washer fluid reservoir is empty, otherwise you will damage the washer pump. ◀

## Windshield washer nozzles

The windshield washer nozzles are heated automatically\* while the engine is running or the ignition is switched on.

## Washer fluid

 Washer fluid antifreeze is flammable. Therefore, keep it away from ignition sources and only store it in the closed original container that is kept out of reach of children, otherwise there is a risk of personal injury. Comply with the instructions on the container. ◀

## Washer fluid filler neck

 Only refill washer fluid when the engine is cool to avoid contact with hot engine parts. Otherwise, fluid spills constitute a fire hazard and a risk to personal safety. ◀

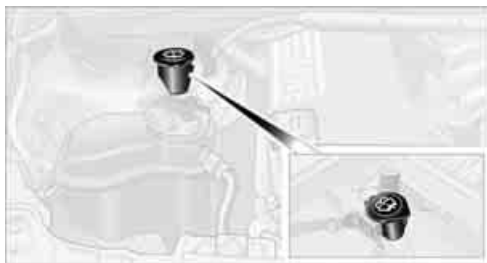

All washer nozzles are supplied with washer fluid by the same reservoir.

Fill with water and, if required, with a washer antifreeze, according to manufacturer's recommendations.

 Mix the water and antifreeze before filling the washer fluid reservoir to make sure the correct concentration is maintained. ◀

## Capacity

Approx. 6.3 US quarts/6 liters.

## Cruise control\*

### The concept

You can use the cruise control feature beginning at approx. 20 mph/30 km/h. The car then stores and maintains the speed that you specify using the lever on the steering column.

 Do not use cruise control when driving at constant speed is prevented by adverse conditions, e.g. winding roads, dense traffic or poor road conditions due to, e.g. snow, rain, ice or loose surfaces. Otherwise you could lose control of the vehicle and cause an accident as a result. ◀

### One lever for all functions

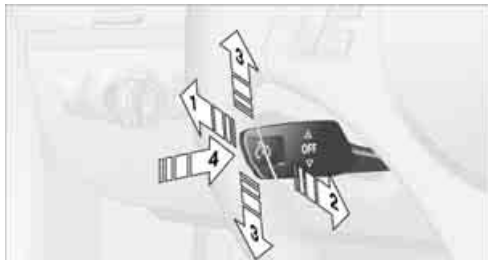

- 1 Storing and maintaining speed or accelerating
- 2 Storing and maintaining speed or decelerating
- 3 Deactivating cruise control
- 4 Resuming a speed stored beforehand

### Maintaining current speed

Tap the lever, arrow **1**, or pull it briefly, arrow **2**. The car's current speed is stored and maintained. It is briefly displayed in the instrument cluster.

If the engine braking power is insufficient on a downhill slope, the set speed may be exceeded. On uphill gradients, it may prove impossible to maintain the set speed if engine power output is insufficient.

### Increasing speed

Repeatedly press the lever, arrow **1**, until the desired speed is reached.

Each time the lever is pressed lightly, the speed is increased by approx. 1 mph/1 km/h.

### Accelerating using the lever

Press the lever, arrow **1**, until the desired speed is reached.

The vehicle accelerates without pressure on the accelerator pedal. The system stores and maintains the speed.

### Decreasing speed

Repeatedly pull the lever, arrow **2**, until the desired speed is reached.

The functions are the same as when the set speed is increased or the vehicle is accelerated, except that in this case the speed decreases.

### Deactivating cruise control

Tap the lever upwards or downwards, arrow **3**.

In addition, the system is automatically deactivated:

- ▷ When you brake the vehicle
- ▷ When you depress the clutch of a manual transmission or shift to neutral
- ▷ When you select the automatic transmission's neutral position N
- ▷ When the vehicle travels faster or slower than the set speed for an extended period, e.g. when the accelerator is depressed
- ▷ When you activate DTC or deactivate DSC
- ▷ When DSC is intervening

### Resuming a speed stored beforehand

Press the button, arrow **4**.

The last stored speed is resumed and maintained.

The stored speed is briefly displayed in the instrument cluster.

The stored speed is cleared when the ignition is switched off.



## Display in the instrument cluster



When the speed at which the vehicle is traveling is stored or when a stored speed is called up, the speed is briefly displayed in the instrument cluster.

# Everything under control

## Odometer, outside temperature display, clock

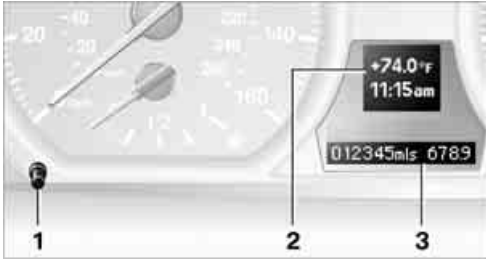

- 1 Knob in the instrument cluster
- 2 Outside temperature and clock
- 3 Odometer and trip odometer

### Knob in the instrument cluster

- ▷ To reset the trip odometer while the ignition is switched on
- ▷ To display the time, outside temperature and odometer briefly while the ignition is switched off

### Units of measure

To select the respective units of measure, miles or km for the odometer as well as °F or °C for the outside temperature, refer to Formats and units of measure on page 60.

The setting is stored for the remote control currently in use.

### Time, outside temperature display

Setting the time, refer to page 62.

### Outside temperature warning

When the displayed temperature sinks to approx. +37 °F/+3 °C, a signal sounds and a warning lamp lights up. There is an increased risk of black ice.

**⚠** Black ice can also form at temperatures above +37 °F/+3 °C. You should therefore drive carefully on bridges and shaded

roads, for example, otherwise there is an increased risk of an accident. ◀

### Odometer and trip odometer

Resetting trip odometer:

With the ignition switched on, press button 1 in the instrument cluster.

### When the vehicle is parked

If you still want to view the time, outside temperature and odometer reading briefly after the remote control has been taken out of the ignition lock:

Press button 1 in the instrument cluster.

## Tachometer



Never force the engine speed up into the red warning field, see arrow. In this range, the fuel supply is interrupted to protect the engine.

## Coolant temperature

A warning lamp will come on if the coolant, and therefore the engine, becomes too hot.

Check coolant level, refer to page 117.

## Engine oil temperature\*



When the engine is at normal operating temperature, the engine oil temperature is between approx. 210 °F/100 °C and approx. 300 °F/150 °C.

If the engine oil temperature is too high, a warning lamp comes on in the instrument cluster.

## Fuel gauge



Fuel tank capacity: approx. 14 US gallons/ 53 liters.

You can find information on refueling on page 104.

If the tilt of the vehicle varies for a longer period, when you are driving in mountainous areas, for example, the indicator may fluctuate slightly.

Fuel display 135i: in speedometer.

## Reserve



Once the fuel level has fallen to the reserve zone, the indicator lamp lights up briefly and the cruising range for the remaining amount of fuel is displayed. The indicator lamp stays on permanently when the remaining range is less than approx. 30 miles/50 km.

 Refuel as soon as possible once your cruising range falls below 30 miles/50 km, otherwise engine functions are not ensured and damage can occur. ◀

## Computer

### Displays in the instrument cluster

#### Calling up information

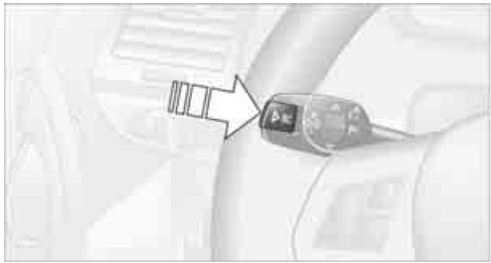

Press the button in the turn indicator lever.



## Current fuel consumption

Displays the current fuel consumption. This allows you to see whether your current driving style is conducive to fuel economy with minimum exhaust emissions.

The following items of information are displayed in the order listed:

- ▷ Cruising range
- ▷ Average speed
- ▷ Average fuel consumption
- ▷ Current fuel consumption
- ▷ No information

To set the corresponding units of measure, refer to Formats and units of measure on page 60.

## Cruising range

Displays the estimated cruising range available with the remaining fuel. The range is calculated on the basis of the way the car has been driven over the last 18 miles/30 km and the amount of fuel currently in the tank.



It is important that you refuel as soon as possible once your cruising range falls below 30 miles/50 km, otherwise engine functions are not ensured and damage can occur. ◀

## Average speed

Periods with the vehicle parked and the engine switched off are not included in the calculations of average speed.

To reset average speed: press the button in the turn indicator lever for approx. 2 seconds.

## Average fuel consumption

The average fuel consumption is calculated for the time during which the engine is running.

To reset average fuel consumption: press the button in the turn indicator lever for approx. 2 seconds.

# Settings and information

## Operating principle



Certain settings and information can only be made or called up when the ignition is switched on. A number of settings cannot be made while driving.

- 1 Button for:
  - ▷ Selecting display
  - ▷ Setting values
- 2 Button for:
  - ▷ Confirming selected display or set values
  - ▷ Calling up computer information 57
- 3 When the lights are on: instrument lighting brightness 77
- 4 Calling up Check Control 62
- 5 Checking oil level 115
- 6 Initializing the Flat Tire Monitor 66  
Resetting the Tire Pressure Monitor 68
- 7 Setting the time 62
- 8 Setting the date 62

- 9 Viewing service requirement display 61

- 10 Setting formats and units of measure, resetting to factory settings 60

- 11 Adjusting settings

- ▷ Confirmation signals when locking and unlocking the vehicle 21
- ▷ Response during unlocking procedure 19
- ▷ Automatic locking 22
- ▷ Pathway lighting 74
- ▷ Daytime running lamps 75
- ▷ Triple turn signal activation 52
- ▷ Seat and mirror memory\* 39

### Exiting displays

The outside-temperature reading and the time reappear when you press button 2 or if you make no entries within approx. 15 seconds. If required, complete the current setting first.

## Formats and units of measure

You can set formats and units of measure.

For operating principle refer to page 59.

1. Switch on the ignition, refer to page 47.
2. Lightly push button **1** in the turn indicator lever up or down repeatedly until the symbol appears in the display accompanied by the word "SET".



3. Press button **2**.
4. Use button **1** to select desired format or desired unit of measure, e.g. for fuel consumption.



- ▷ Fuel consumption: mpg, km/l, l/100km
- ▷ Distance covered: mls, km
- ▷ Time: 12h, 24h format
- ▷ Date: day.month dd.mm, month/day mm/dd
- ▷ Temperature: °F, °C

5. Press button **2**.
6. Use button **1** to make the setting.
7. Press button **2**.  
The setting is stored for the remote control currently in use.

## Resetting to factory settings

You can reset the formats and units of measure back to the default settings.

1. Lightly push button **1** in the turn indicator lever up or down repeatedly until the symbol appears in the display accompanied by the word "SET".



2. Press button **2**.
3. Use button **1** to select "RESET".



4. Press button **2** until is displayed.  
The settings are reset.  
The setting is stored for the remote control currently in use.

## Service requirements



The remaining driving distance and the date of the next scheduled service are displayed briefly immediately after you start the engine or switch on the ignition.

 The extent of service work required can be read out from the remote control by your BMW Service Advisor. ◀

For certain maintenance operations, you can view the respective distance remaining or due date individually in the instrument cluster.



1. Switch on the ignition, refer to page 47.
2. Push button **1** in the turn indicator lever up or down repeatedly until the appropriate symbol appears in the display, accompanied by the words "SERVICE-INFO".
3. Press button **2**.
4. Use button **1** to scroll through the individual service items.

## Possible displays

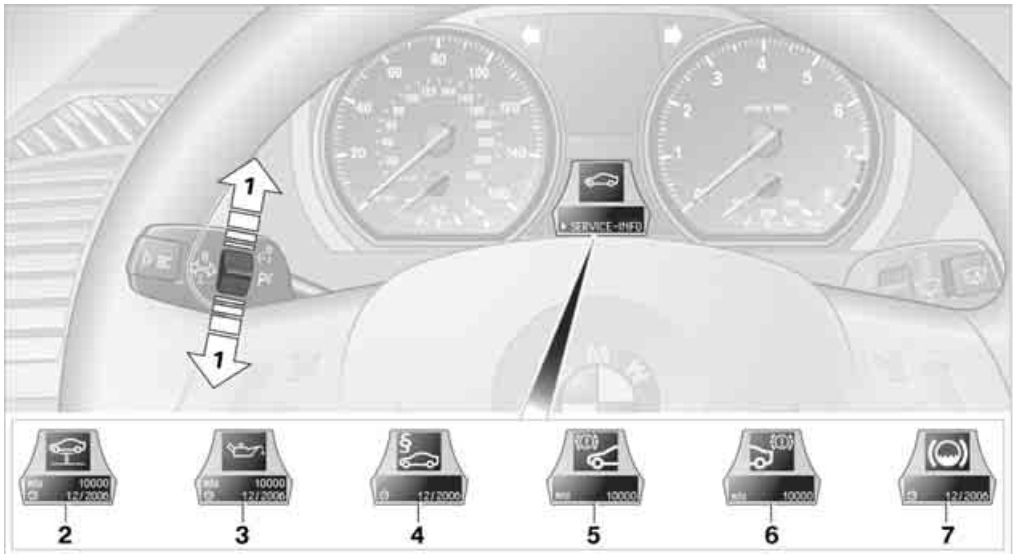

- |   |                           |
|---|---------------------------|
| <b>1</b> Button for selecting functions | <b>5</b> Front brake pads |
| <b>2</b> Service requirements           | <b>6</b> Rear brake pads  |
| <b>3</b> Engine oil                     | <b>7</b> Brake fluid      |
| <b>4</b> Roadworthiness test*           |                           |

The sequence of displayed service items may vary. The data for the next service appointment is shown first.

## Clock

### Setting the time

#### In the instrument cluster

To set the 12h/24h format, refer to Formats and units of measure on page 60.



1. Push button **1** in the turn indicator lever up or down repeatedly until the appropriate symbol appears in the display, accompanied by the time and the word "SET".
2. Press button **2**.
3. Use button **1** to set the hours.
4. Press button **2** to confirm the entry.
5. Use button **1** to set the minutes.
6. Press button **2** to confirm the entry.
7. Press button **2**.

The system accepts the new time.

## Date

### Setting the date

#### In the instrument cluster

To set the dd/mm or mm/dd date format, refer to Formats and units of measure on page 60.



1. Push button **1** in the turn indicator lever up or down repeatedly until the appropriate symbol appears in the display, accompanied by the date and the word "SET".
  2. Press button **2**.
  3. Use button **1** to set the day of the month.
  4. Press button **2** to confirm the entry.
  5. Set the month and the year in the same way.
  6. Press button **2**.
- The system stores the new date.

## Check Control

### The concept

The Check Control monitors vehicle functions and alerts you to any malfunctions in the systems monitored. Such a Check Control message includes indicator or warning lamps in the instrument cluster and, in some circumstances, a signal.





Indicator and warning lamps can light up in a variety of combinations and colors.



▲ indicates that Check Control messages have been stored. You can view the Check Control messages whenever it is convenient for you.

### What to do in case of a malfunction

The meaning of each lamp in the event of a malfunction and tips on how to respond are listed starting on page 134.

### Hiding Check Control messages

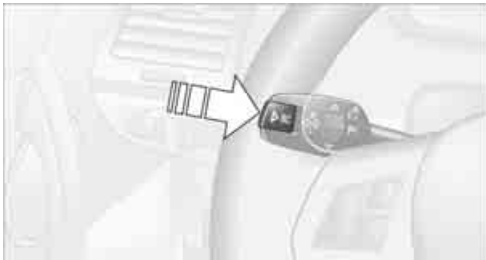

Press the button in the turn indicator lever.

Some Check Control messages are displayed until the respective malfunction has been rectified. They cannot be hidden. If several malfunctions occur at the same time, they are displayed in succession.

Other Check Control messages are automatically hidden after approx. 20 seconds, but are kept in memory.

### Viewing stored Check Control messages



1. Push button **1** in the turn indicator lever up or down repeatedly until the appropriate symbol appears in the display, accompanied by the words "CHECK".
2. Press button **2**. "CHECK OK" appears if there are no Check Control messages. If a Check Control message has been stored, the corresponding lamp comes on.
3. Push button **1** to check for other messages.
4. Press button **2**. The display again shows the outside temperature and the time.

# Technology for driving comfort and safety

## Park Distance Control PDC\*

### The concept

The PDC assists you with maneuvering in tight parking spaces. Acoustic signals warn you of the presence of an object behind your vehicle. Four ultrasonic sensors in the bumper measure the distance.

An acoustic warning does not sound until an object is closer than approx. 2 ft/60 cm to the corner sensors, or closer than approx. 5 ft/1.50 m to the center sensors.

 PDC is a parking aid that can indicate objects when they are approached slowly, as is usually the case when parking. Avoid approaching an object at high speed, otherwise physical circumstances may lead to the system warning being issued too late. ◀

### Switching on automatically

With the engine running or the ignition switched on, the system is activated after approx. 1 second when you engage reverse gear or move the automatic transmission selector lever to position R. Wait this short period before driving.

### Switching off automatically

After approx. 55 yd/50 m of driving or above approx. 20 mph/30 km/h, the system switches off and the LED goes out.

### Signal tones

When nearing an object, its position is indicated correspondingly by an interval tone. As the distance between vehicle and object decreases, the intervals between the tones become shorter. If the distance to the nearest object falls to below roughly 1 ft/30 cm, then a continuous tone sounds.

An interval tone is interrupted after approx. 3 seconds:

- ▷ If you remain in front of an object that has been detected by only one of the corner sensors
- ▷ If you are driving parallel to a wall

### Malfunction



The indicator lamp in the instrument cluster comes on. PDC is malfunctioning. Have the system checked.

To avoid this problem, keep the sensors clean and free of ice or snow in order to ensure that they will continue to operate effectively. When using a high-pressure cleaner, do not direct the jet toward the sensors for lengthy periods and only spray from a distance of at least 4 in/10 cm.

### System limitations

 Even with PDC, final responsibility for estimating the distance between the vehicle and any obstructions always remains with the driver. Even when sensors are provided, there is a blind spot in which objects can no longer be detected. The system is also subject to the physical limits that apply to all forms of ultrasonic measurement, such as those encountered with trailer towbars and hitches, thin or wedge-shaped objects, etc. Low objects that have already been displayed, e.g. curbs, can disappear again from the detection area of the sensors before or after a continuous tone sounds. Higher, protruding objects, e.g. ledges, cannot be detected. Loud sound sources outside or inside the car can drown out the PDC signal. Therefore, always drive cautiously, otherwise there is a risk of personal injury or property damage. ◀

## Driving stability control systems

Your BMW has a number of systems that help to maintain the vehicle's stability even in adverse driving conditions.

## Antilock Brake System ABS

ABS prevents locking of the wheels during braking. Safe steering response is maintained even during full braking. Active safety is thus increased.

The ABS is operational every time you start the engine. Braking safely, refer to page 98.

## Electronic brake-force distribution EBV

The system controls the brake pressure in the rear wheels to ensure stable braking behavior.

## Dynamic Brake Control DBC

When you apply the brakes rapidly, this system automatically produces the maximum braking force boost and thus helps to achieve the shortest possible braking distance during full braking. This system exploits all of the benefits provided by ABS.

Do not reduce the pressure on the brake for the duration of the full braking application.

## Dynamic Stability Control DSC

DSC prevents the driving wheels from losing traction when you pull away from rest or accelerate. The system also recognizes unstable driving conditions, for example if the rear of the car is about to swerve or if momentum is acting at an angle past the front wheels. In these cases, DSC helps the vehicle maintain a safe course within physical limits by reducing engine output and through braking actions at the individual wheels.

 The laws of physics cannot be repealed, even with DSC. An appropriate driving style always remains the responsibility of the driver. Therefore, do not reduce the additional safety margin again by taking risks, as this could result in an accident. ◀

## Deactivating DSC



Press the button for at least 3 seconds; the indicator lamps for DSC in the instrument cluster light up. Dynamic Traction Control DTC and DSC have been simultaneously deactivated. Stabilizing and drive-output promoting actions are no longer executed.

In the same way as with a differential interlock, even if DSC is deactivated, brake actions are still performed on the rear axle to enhance drive output if the drive wheels experience a significant loss of traction.

To increase vehicle stability, activate DSC again as soon as possible.

## Activating DSC

Press the button again; the indicator lamps for DSC in the instrument cluster go out.

## For better control



If the indicator lamp flashes:  
DSC is regulating the drive and braking forces.



If the indicator lamps are on:  
DSC is deactivated.



## Dynamic Traction Control DTC

DTC is a version of DSC in which the drive output is optimized for particular road conditions, e.g. unplowed snow-covered roads. The system assures the maximal drive output, but with reduced driving stability. It is therefore necessary to drive with appropriate caution.

You may find it useful to briefly activate DTC under the following special circumstances:

- ▷ When driving uphill on snow-covered roads, in slush or on unplowed, snow-covered roads
- ▷ When rocking a stuck vehicle free or starting off in deep snow or on loose ground
- ▷ When driving with snow chains

### Activating DTC



Press the button; the indicator lamps for DTC in the instrument cluster come on.

#### For better control

 If the indicator lamp flashes: DTC is regulating the drive and braking forces.

 If the indicator lamps are on: DTC has been activated.

### Deactivating DTC

Press the button again; the DTC indicator lamps in the instrument cluster go out.

## Drive-off assistant

The drive-off assistant enables you to drive off smoothly on uphill gradients. It is not necessary to use the parking brake for this.

1. Hold the car in place by depressing the brake.
2. Release the brake and drive off without delay.

 The drive-off assistant holds the car in place for approx. 2 seconds after the brake is released. Drive off without delay after releasing the brake. Otherwise, the drive-off

assistant will no longer hold the car in place after approx. 2 seconds and the car will start to roll backwards. ◀

## Flat Tire Monitor FTM\*

### The concept

The Flat Tire Monitor detects pressure loss in a tire by comparing the rotating speeds of the individual tires while moving.

In the event of pressure loss, the rolling circumference changes and, thus, the rotating speed of the affected wheel. This change is detected and is reported as a flat tire.

### Functional requirement

In order to assure the reliable reporting of a flat tire, the system must be initialized for the correct tire inflation pressure.

 The system must be reinitialized each time a tire inflation pressure has been corrected or a wheel or tire has been changed. ◀

### System limitations

 The Flat Tire Monitor is unable to warn the driver of sudden, severe tire damage caused by external factors, nor can it identify the gradual loss of pressure that will inevitably occur in all four tires over a lengthy period of time. ◀

In the following situations, the system could be delayed or malfunction:

- ▷ System has not been initialized
- ▷ Driving on snowy or slippery road surface
- ▷ Performance-oriented style of driving: slip in the drive wheels, high lateral acceleration
- ▷ Snow chains are attached

### Initializing the system

 The initialization is completed during driving, which can be interrupted at any time. When driving resumes, the initialization is continued automatically. Do not initialize the system while snow chains are attached. ◀

1. Start the engine immediately before pulling away, but do not drive off yet.





2. Lightly push button 1 in the turn indicator lever up or down repeatedly until the corresponding symbol appears in the display accompanied by the word "RESET".
3. Press button 2 to confirm your choice of the Flat Tire Monitor.
4. Press button 2 for approx. 5 seconds, until the reading shown below is displayed:



5. Start to drive.  
Initialization is completed while the car is on the move, without any feedback.

### Indication of a flat tire

 The warning lamps come on in yellow and red. In addition, a signal sounds.  There is a flat tire or substantial loss of tire pressure.

1. Cautiously reduce speed to below 50 mph/80 km/h. Avoid sudden braking and steering maneuvers. Do not exceed a speed of 50 mph/80 km/h.

 If the car is not equipped with Run-Flat Tires, refer to page 112, the standard equipment by design, do not continue

driving. A severe accident could result if you continue driving after a tire puncture. ◀

2. At the next opportunity, check the air pressure in all four tires.

 If all four tires are inflated to the correct pressures, the Flat Tire Monitor might not have been initialized. The system must then be initialized. ◀



3. In the event of complete tire pressure loss, 0 psi/0 kPa, you can estimate the distance for which you can continue driving on the basis of the following guidelines:

- ▶ With a light load:  
1 to 2 persons without luggage:  
approx. 155 miles/250 km
- ▶ With a medium load:  
2 persons, cargo bay full, or 4 persons without luggage:  
approx. 90 miles/150 km
- ▶ With a full load:  
4 persons, cargo bay full:  
approx. 30 miles/50 km

 Drive cautiously and do not exceed a speed of 50 mph/80 km/h, otherwise there is a risk of an accident. In the event of pressure loss, vehicle handling changes. This includes reduced tracking stability in braking, extended braking distance and altered natural steering characteristics.

If unusual vibration or loud noises occur during the journey, this may be an indication that the damaged tire has finally failed. Reduce your speed and pull over as soon as possible at a suitable location. Otherwise parts of the tire could come loose, resulting in an accident. Do not continue driving. Instead, contact your BMW center. ◀

### Malfunction

 The warning lamps come on in yellow. The Flat Tire Monitor has a malfunction or has failed. Have the system checked as soon as possible. 

## Tire Pressure Monitor TPM\*

### The concept

TPM checks the inflation pressures of the four mounted tires. The system notifies you if there is a significant loss of pressure in one or more tires.

### Functional requirement

In order to assure the reliable reporting of a flat tire, the system must be reset while all tire inflation pressures are correct.

Always use wheels with TPM electronics. Otherwise, the system may malfunction.

 Each time a tire inflation pressure has been corrected or a wheel or tire has been changed, reset the system. ◀

### System limitations

 TPM cannot warn you in advance of sudden severe tire damage caused by outside influences. ◀

The system does not work correctly if it has not been reset; for example, a flat tire may be indicated even though the tire inflation pressures are correct.

The system is inactive and cannot indicate a flat tire if a wheel without TPM electronics, such as a compact spare wheel, has been mounted, or if TPM is temporarily malfunctioning due to other systems or devices using the same radio frequency.

### Resetting the system

 Each time a tire inflation pressure has been corrected or a wheel or tire has been changed, reset the system. ◀

For operating principle refer to page 59.

1. Start the engine, but do not start driving.
2. Lightly push button 1 in the turn indicator lever up or down repeatedly until the corre-

sponding symbol appears in the display accompanied by the word "RESET".



3. Press button 2 to confirm your choice of the Tire Pressure Monitor. The following display appears:



4. Press button 2 for approx. 5 seconds, until the reading shown below is displayed:



5. Start to drive.  
After driving a few minutes, the set inflation pressures in the tires are accepted as the target values to be monitored. The system reset is completed during your drive, and can be interrupted at any time. When driving resumes, the reset is continued automatically. The indicator lamp goes out after the system reset is completed.

## Message for low tire inflation pressure



The warning lamps come on in yellow and red. In addition, a signal sounds. There is a flat tire or substantial loss of tire pressure.

1. Cautiously reduce speed to below 50 mph/80 km/h. Avoid sudden braking and steering maneuvers. Do not exceed a speed of 50 mph/80 km/h.



If the car is not equipped with Run-Flat Tires, refer to page 112, the standard equipment by design, do not continue driving. Otherwise a severe accident could result after a tire puncture if you continue driving. ◀

2. In the event of complete pressure loss, 0 psi/0 kPa, you can estimate the possible distance for continued driving on the basis of the following guidelines:

- ▷ With a light load:  
1 to 2 persons without luggage:  
approx. 155 miles/250 km
- ▷ With a medium load:  
2 persons, cargo bay full, or 4 persons without luggage:  
approx. 95 miles/150 km
- ▷ With a full load:  
4 persons, cargo bay full:  
approx. 30 miles/50 km



Drive cautiously and do not exceed a speed of 50 mph/80 km/h. In the event of pressure loss, vehicle handling changes. This includes reduced tracking stability in braking, extended braking distance and altered natural steering characteristics.

If unusual vibration or loud noises occur during the journey, this may be an indication that the damaged tire has finally failed. Reduce your speed and pull over as soon as possible at a suitable location. Otherwise parts of the tire could come loose, resulting in an accident. Do not continue driving. Instead, contact your BMW center. ◀

## Malfunction



The small warning lamp flashes in yellow and then lights up continuously; the larger warning lamp comes on in yellow. No punctures can be detected.

This type of message is shown in the following situations:

- ▷ If there is a malfunction  
Have the system checked.
- ▷ If a wheel without TPM electronics has been mounted
- ▷ If TPM is temporarily malfunctioning due to other systems or devices using the same radio frequency.

## Message for unsuccessful system reset



The warning lamp lights up yellow. The system is not reset after a tire has been changed, for example.

Check the tire inflation pressure and reset the system, refer to page 68.

## Declaration according to NHTSA/FMVSS 138 Tire Pressure Monitoring Systems

Each tire should be checked monthly when cold and inflated to the inflation pressure recommended by the vehicle manufacturer on the vehicle placard or tire inflation pressure label. If your vehicle has tires of a different size than the size indicated on the vehicle placard or tire inflation pressure label, you should determine the proper tire inflation pressure for those tires. As an added safety feature, your vehicle has been equipped with a tire pressure monitoring system, TPMS, that illuminates a low tire pressure telltale when one or more of your tires are significantly under-inflated. Accordingly, when the low tire pressure telltale illuminates, you should stop and check your tires as soon as possible, and inflate them to the proper pressure. Driving on a significantly underinflated tire causes the tire to overheat and can lead to tire failure. Underinflation also reduces fuel efficiency and tire tread life, and may affect the vehicle's han-



dling and stopping ability. Please note that the TPMS is not a substitute for proper tire maintenance, and it is the driver's responsibility to maintain correct tire pressure, even if underinflation has not reached the level at which the TPMS low tire pressure telltale illuminates.

The TPMS malfunction indicator is combined with the low tire pressure telltale. When the system detects a malfunction, the telltale will flash for approximately one minute and then remain continuously lit. This sequence will continue upon subsequent vehicle startups as long as the malfunction exists. When the malfunction indicator is illuminated, the system may not be able to detect or signal low tire pressure as intended. TPMS malfunctions may occur for a variety of reasons, including the installation of replacement or alternate tires or wheels on the vehicle that prevent the TPMS from functioning properly. Always check the TPMS malfunction telltale after replacing one or more tires or wheels on your vehicle to ensure that the replacement or alternate tires and wheels allow the TPMS to continue to function properly.

## Active steering\*

### The concept

Active steering varies the turning angle of the front wheels in relation to steering wheel movements. It also varies the steering force required to turn the wheels depending on the speed at which you are driving.

When you are driving in the low road-speed range, e.g. in a town or when parking, the steering angle increases, i.e. the steering becomes very direct, and less effort is required to turn the wheels. In the higher speed range, on the other hand, the steering angle is reduced more and more. This improves the handling capability of your BMW over the entire speed range.

In critical situations, the system can make targeted corrections to the steering angle provided by the driver and thus stabilize the vehicle before the driver intervenes. This stabilizing

intervention is simultaneously deactivated when DSC is switched off, refer to page 65.

## Malfunction



The warning lamps come on. Active steering is no longer operational. At low speeds, greater steering wheel movements are required, whereas at

higher speeds the vehicle reacts more sensitively to steering wheel movements. The stability-enhancing feature may also be deactivated. Drive cautiously and think well ahead. Have the system checked.

## Brake Force Display\*

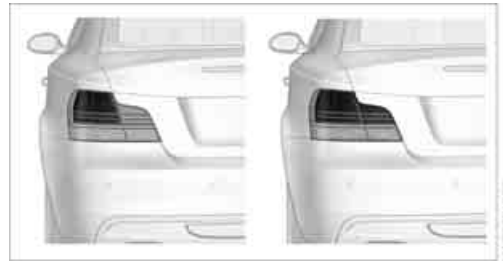

On the left: normal braking.

On the right: sharp braking.



# Airbags

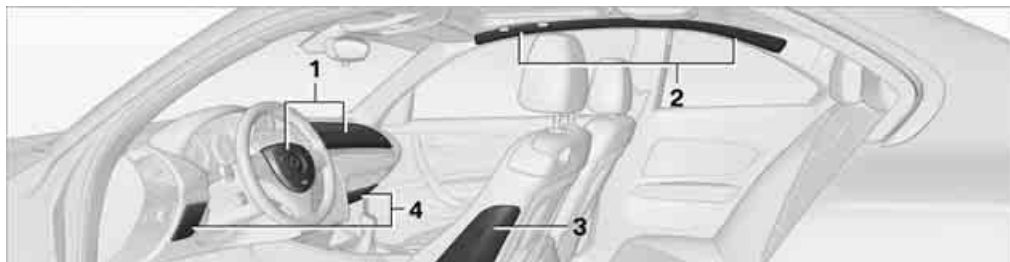

The following airbags are located under the marked covers:

- 1 Front airbags
- 2 Coupe: head airbags
- 3 Side airbags in the seat backrests
- 4 Convertible: knee airbags

## Protective action

 Observe the adjustment instructions on page 35 to ensure the best possible personal protection. ◀

The front airbags help protect the driver and front passenger by responding to frontal impacts in which safety belts alone cannot provide adequate restraint. When needed, the head and side airbags help provide protection in the event of side impact. The relevant side airbag supports the side upper body area. The head air bag supports the head.

The airbags have been designed to not be triggered in every collision situation, e.g. not in minor accidents or rear-end collisions.

 Do not apply adhesive materials to the cover panels of the airbags, cover them or modify them in any other way.

Keep the dashboard and window on the front passenger side clear, i.e. do not cover with adhesive labels or coverings, and do not attach holders such as for navigation instruments and mobile phones.

Do not attach seat covers, cushions or other objects not specifically approved for seats with integral side airbags to the front seats. Do not hang items of clothing such as coats or jackets over the backrests. Do not attempt to remove

the airbag retention system from the vehicle. Do not modify the individual components of the system or its wiring in any way. This includes the upholstered covers on the steering wheel, instrument panel, seats and roof posts, as well as the sides of the roof lining. Do not attempt to remove or dismantle the steering wheel. Do not touch the individual components immediately after the system has been triggered, because there is a danger of burns.

In the event of malfunctions, deactivation or triggering of the airbag restraint system, have the testing, repair, removal and disposal of airbag generators executed only by a BMW center or a workshop that works according to repair procedures of BMW with correspondingly trained personnel and that has the required explosives licenses. Unprofessional attempts to work on the system could lead to failure in an emergency or to undesired airbag activation, either of which could result in personal injury. ◀

Warning notices and information about the airbags can also be found on the sun visors.

## Automatic deactivation of the front passenger airbags

An analysis of the impression in the front passenger seat cushion determines whether and how the seat is occupied. The front and side airbags for the front passenger are activated or deactivated by the system accordingly.

 The indicator lamp above the interior rearview mirror shows the current status of the front passenger airbags, deactivated or activated, refer to Status of front passenger airbags below. ◀

**⚠** Before transporting a child on the front passenger seat, read the safety precautions and handling instructions under Transporting children safely, refer to page 44. The front and side airbags can also be deactivated by adolescents and adults sitting in certain positions; the indicator lamp for the front passenger airbags comes on. In such cases, the passenger should change his or her sitting position so that the front passenger airbags are activated and the indicator lamp goes out. If the desired airbag status cannot be achieved by changing the sitting position, transport the relevant passenger on a rear seat. Do not attach seat covers, seat cushion padding, ball mats or other items to the front passenger seat unless they are specifically recommended by BMW. Do not place any items under the seat which could press against the seat from below. Otherwise a correct analysis of the seat cushion is not ensured. ◀

### Status of front passenger airbags



The indicator lamp for the front passenger airbags shows the functional status of the front passenger's front and side airbags in accordance with whether and how the front passenger seat is occupied. The indicator lamp shows whether the front passenger airbags are activated or deactivated.

▷ The indicator lamp lights up when a child in a specially designated child-restraint system is detected, as intended, on the seat. The front and side airbags for the front passenger are not activated.

▷ Most child seats are detected by the system, especially child seats required by the NHTSA at the time of vehi-

cle production. After mounting a child seat, ensure that the indicator lamp for the front passenger airbag is lit. It indicates that the child seat has been detected and that the front passenger airbags are deactivated. ◀

- ▷ The indicator lamp does not come on as long as a person of sufficient size and in a correct sitting position is detected on the seat. The front and side airbags for the front passenger are activated.
- ▷ The indicator lamp does not come on if the seat is empty. The front and side airbags for the front passenger are not activated.

### Operational readiness of airbag system



As of radio readiness, refer to page 47, the warning lamp comes on briefly to indicate that the entire airbag system and the belt tensioners are operational.

### Airbag system malfunction

- ▷ Warning lamp does not light up at radio readiness or beyond.
- ▷ Warning lamp remains permanently on.

**⚠** In the event of a fault in the airbag system, have it checked without delay, otherwise there is the risk that the system will not function as intended even if a sufficiently severe accident occurs. ◀

### Convertible: rollover protection system

The rollover protection system is activated automatically in the event of an accident, a crit-

ical driving situation, an extreme tilt in the car's longitudinal axis or upon loss of ground contact. The protection bars behind the rear head restraints deploy within fractions of a second. As a supplementary system to the reinforced windshield frame, the rollover protection system ensures that the necessary headroom is maintained for all vehicle occupants.

 Always keep the area of movement of the rollover protection system clear. In minor accidents, you are protected by the fastened safety belt and, depending on accident severity, by the safety belt tensioner and multi-phase airbag retention system. ◀

## Resetting

If the rollover protection system was not impacted after being automatically activated, it can be reset by lowering the protection bars to their original positions. This does not require tools.

1. Push the locking lever to one side and hold it there.

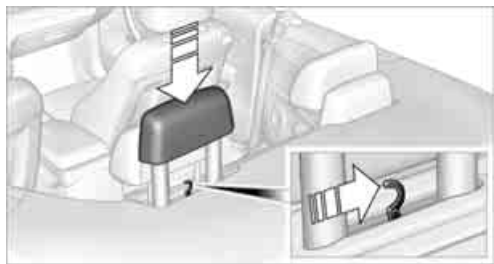

2. Push the protection bar halfway down from above.
3. Release the locking lever.

4. Push the protection bar down until it snaps into place.

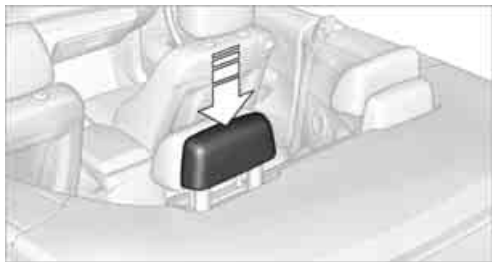

5. Repeat the procedure for the other protection bar.

Have the rollover protection system checked after an unexpected activation.

 Never move the convertible top when the rollover protection system is in the activated position.

Do not make any modifications to the individual components of the rollover protection system or its cabling.

Work on the rollover protection system should only be performed by a BMW center.

Incorrectly performed work on the system may lead to system failure or incorrect operation.

To check the system and ensure flawless long-term operation, always observe the service intervals, refer to page 61. ◀

# Lamps

## Parking lamps/low beams

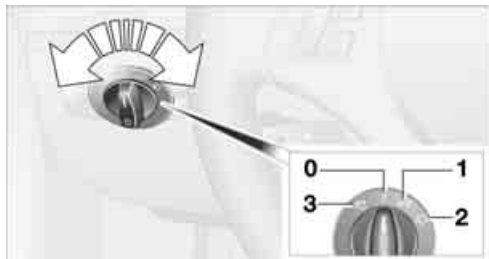

- 0** Lamps off, daytime running lamps
- 1** Parking lamps and daytime running lamps
- 2** Low beams, welcome lamps\*
- 3** Automatic headlamp control\*, daytime running lamps\*, welcome lamps\* and Adaptive Head Light\*

When you open the driver's door with the ignition switched off, the exterior lighting is automatically switched off if the light switch is in position **0**, **2** or **3**.

Switch on the parking lamps if necessary, switch position **1**.

### Parking lamps

In switch position **1**, the front, rear and side vehicle lighting is switched on. You can use the parking lamps for parking.

 The parking lamps will discharge the battery. Therefore, do not leave them on for unduly long periods of time, otherwise the battery might not have enough power to start the engine. It is preferable to switch on the left-hand or right-hand roadside parking lamps, refer to page [76](#).

### Low-beam headlamps

The low beams light up when the light switch is in position **2** and the ignition is on.

### Automatic headlamp control\*

When the switch is in position **3**, the low beams are switched on and off automatically depending on ambient light conditions, e.g. in a tunnel, in twilight, or if there is precipitation. The Adaptive Head Light\* is active. The LED next to the symbol is illuminated when the low beams are on. You can also activate the daytime running lamps, refer to page [75](#). In the situations described above, the lamps then automatically switch from daytime running lamps to low beams.

The headlamps may also come on when the sun is sitting low on a blue sky.

 The low beams remain switched on independent of the ambient lighting conditions when you switch on the fog lamps\*.

 The automatic headlamp control cannot serve as a substitute for your personal judgment in determining when the lamps should be switched on in response to ambient lighting conditions. For example, the system cannot detect fog or hazy weather. To avoid safety risks, you should always switch on the low-beam headlamps manually under these conditions.

### Welcome lamps

If you leave the light switch in position **2** or **3** when you park the car, the parking lamps and the interior lamps light up briefly when you unlock the vehicle.

### Pathway lighting

If you activate the headlamp flasher after parking the car, with the lamps switched off, the low beams come on and remain on for a certain time.

You can adjust the operating period or deactivate the function.

For operating principle refer to page [59](#).

1. Switch on the ignition, refer to page 47.
2. Lightly push button **1** in the turn indicator lever up or down repeatedly until the symbol appears in the display accompanied by the word "SET".

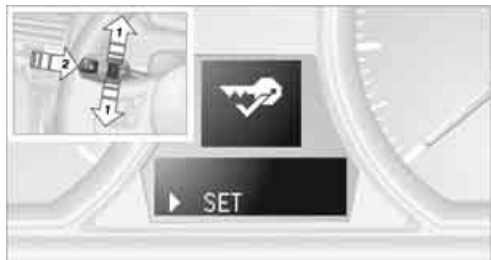

3. Press button **2**.
4. Lightly push button **1** in the turn indicator lever down repeatedly until the symbol appears in the display.



5. Press button **2**.
6. Use button **1** to select:
  - ▷ **0 s**  
The function is deactivated.
  - ▷ **10 s ... 240 s**  
Select the corresponding duration, e.g. 40 seconds.
7. Press button **2**.  
The setting is stored for the remote control currently in use.

### Daytime running lamps\*

The daytime running lamps light up in switch position **0**, **1** and **3**. They are less powerful than the low beams.

### Activating/deactivating daytime running lamps

For operating principle refer to page 59.

1. Switch on the ignition, refer to page 47.
2. Lightly push button **1** in the turn indicator lever up or down repeatedly until the symbol appears in the display accompanied by the word "SET".



3. Press button **2**.
4. Lightly push button **1** in the turn indicator lever down repeatedly until the symbol appears in the display.



5. Press button **2**.
6. Use button **1** to select:
  - ▷ **on**  
Daytime running lamps activated.
  - ▷ **off**  
Daytime running lamps deactivated.
7. Press button **2**.  
The setting is stored for the remote control currently in use.

## Adaptive Head Light\*

### The concept

Adaptive Head Light is a variable headlamp control system that enables better illumination of the road surface. Depending on the steering angle and other parameters, the light from the headlamp follows the course of the road.

In tight curves at speeds up to 40 mph/70 km/h, e.g. on mountainous roads or when turning, an additional, corner-illuminating lamp is switched on that lights up the inside area of the curve.

### Activating Adaptive Head Light

With the ignition switched on, turn the light switch to position **3**, refer to page 74.

The corner-illuminating lamp is switched on automatically, depending on the steering wheel angle or turn signal indicator.

To avoid blinding oncoming traffic, the Adaptive Head Light directs light towards the front passenger side when the vehicle is at a standstill.

When you are reversing, only the corner-illuminating lamps are active and switched on on both sides.

### Malfunction

The LED next to the symbol for automatic headlamp control flashes. Adaptive Head Light is malfunctioning or has failed. Have the system checked as soon as possible.

## High beams/roadside parking lamps\*



- 1 High beams
- 2 Headlamp flasher
- 3 Roadside parking lamps\*

### Roadside parking lamps, left or right\*

There is an additional option of switching on the lamps on the side of the car facing the road when parked.

### Switching on

After parking the vehicle, press the lever up or down beyond the pressure point for approx. 1 second, arrow **3**.

 The roadside parking lamps drain the battery. Therefore, do not leave them on for unduly long periods of time, otherwise the battery might not have enough power to start the engine. ◀

### Switching off

Press the lever in the opposite direction to the pressure point, arrow **3**.

## Fog lamps\*



To switch on/off, press the button.

 The parking lamps or low beams must be switched on for the fog lamps to operate. The green indicator lamp in the instrument cluster lights up whenever the fog lamps are on.

The fog lamps are switched off while you activate the headlamp flasher or switch on the high beams.

 If the automatic headlamp control is activated, the low beams will come on automatically when you switch on the fog lamps. ◀

## Instrument lighting

You can adjust the brightness of the instrument lighting only when the parking lamps or the low beams are switched on.



1. Push button **1** in the turn indicator lever up or down repeatedly until the appropriate symbol appears in the display, accompanied by the brightness level and the word "SET".
2. Press button **2**.



3. Push button **1** up or down to select the desired brightness level.
4. Press button **2**.  
The display again shows the outside temperature and the time.

## Interior lamps

The interior lamps, footwell lamps\*, entry lamps\*, cargo bay lamp and courtesy lamps\* are controlled automatically.

The LEDs for the courtesy lamps are set in the door handles and illuminate the ground in front of the doors.

 To avoid draining the battery, all lamps inside the car are switched off about 8 minutes after the ignition is switched off, refer to Start/stop button on page 47. ◀

## Switching interior lamps on/off manually



Interior lamps, front and rear\*:  
To switch on and off, press the button.

To switch off the interior lamps, footwell lamps\*, entry lamps\* and courtesy lamps\* permanently, press the button for the front interior lamps for about 3 seconds.

## Reading lamps



There are reading lamps at the front and rear\*, next to the interior lamps. To switch on and off, press the button.



# Climate

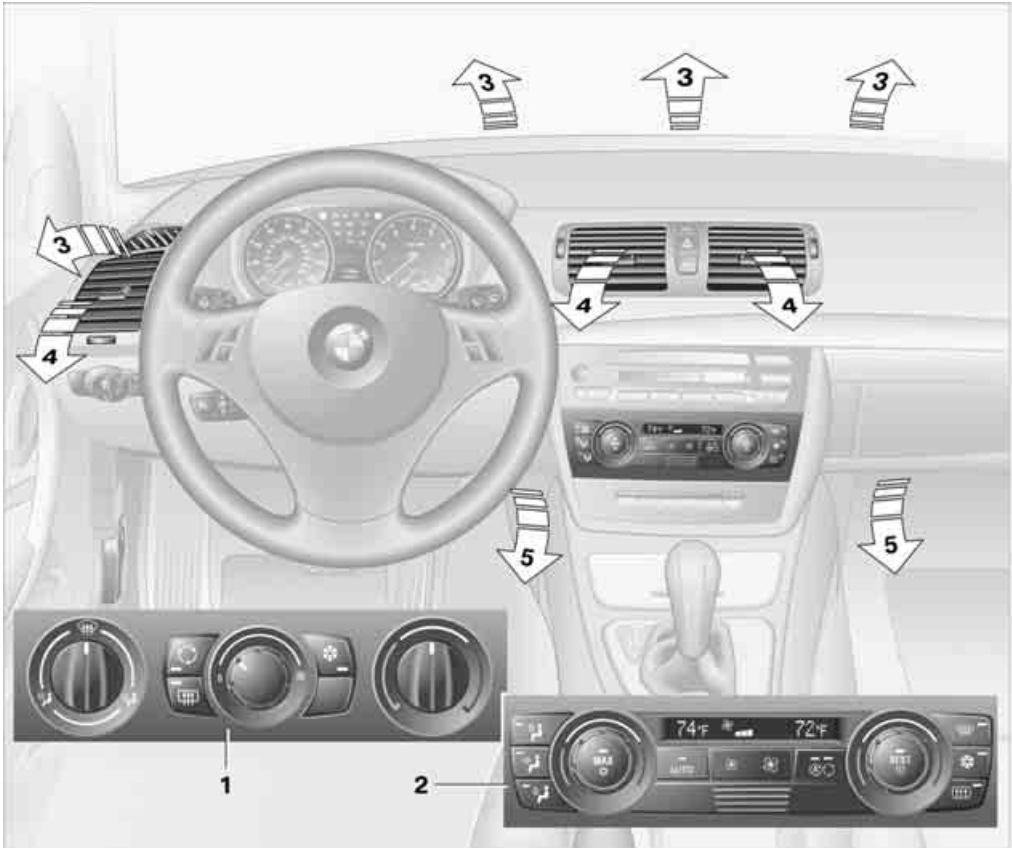

## Equipment versions

Depending on the equipment version, your vehicle contains either an air conditioner\* or an automatic climate control system\*.

- 1 Heating, air conditioner\*
- 2 Automatic climate control\*

## Air vents

- 3 Airflow directed toward the windshield and side windows
- 4 Air to the upper body area.  
The knurled wheels open and close the air supply continuously. The levers alter the direction of the airflow. For further details of draft-free ventilation, refer to page [81](#) or [84](#).
- 5 Air to the footwell

## Heating and ventilation, air conditioner\*

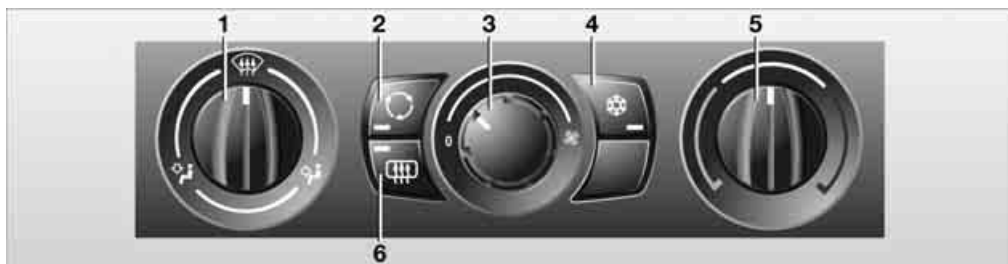



- 1 Air distribution
- 2 Recirculated-air mode
- 3 Air flow rate
- 4 Cooling function\*  
If the vehicle is not equipped with a cooling

function, the rear window defroster is located here.

- 5 Temperature
- 6 Rear window defroster  
If the vehicle is not equipped with a cooling function, this control is located at position 4.

### Air distribution



Direct the flow of air to the windows , to the upper body area  or to the footwell . Intermediate settings are possible.

### Recirculated-air mode



If the air outside the car has an unpleasant odor or contains pollutants, shut off the supply to the interior of the car temporarily. The system then recirculates the air currently within the vehicle. You can also activate/deactivate the recirculated-air mode by means of a button\* on the steering wheel, refer to page 11.

 If condensation starts to form on the inside window surfaces during operation in the recirculated-air mode, you should switch it off while also increasing the air flow rate as required.

The recirculated-air mode should not be used continuously for lengthy periods, otherwise the quality of the air inside the car will gradually deteriorate. ◀

### Air flow rate



Adjust the air flow rate. The higher the rate, the more effective the heating or cooling will be.

The air flow rate may be reduced or the blower may be switched off entirely to save on battery power. The display remains the same.

### Switching the system on/off

To switch on the system, set the desired air flow rate.

Turn the air flow rate rotary switch to 0. Blower and air conditioner are completely switched off and the air supply is cut off.

### Switching the cooling function\* on/off



The cooling function cools and dehumidifies the incoming air before reheating it as required, according to the temperature setting. This function is only available while the engine is running.

The cooling function helps prevent condensation on the windows or removes it quickly.

Depending on the weather, the windshield may fog over briefly when the engine is started.

## Temperature



To increase the temperature, turn the rotary switch clockwise towards red.

To lower the temperature or to cool\* the interior, turn to the left towards blue.

## Rear window defroster





The defroster is switched off automatically after a certain time.

Depending on your vehicle's equipment, the upper wires serve as an antenna and are not part of the rear window defroster.

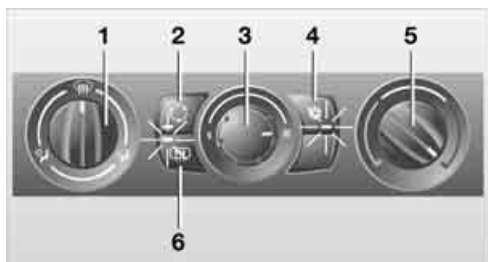
## Defrosting windows and removing condensation



1. Air distribution **1** in position .
2. Deactivate recirculated-air mode **2**.
3. Airflow control **3** all the way to the right.
4. Switch on cooling function **4**.
5. Temperature **5** to the right, red.
6. Switch on rear window defroster **6** to defrost the rear window .

## Ventilation

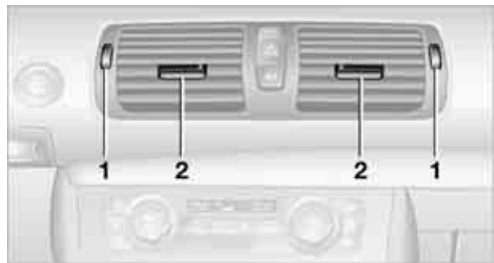

- 1 Use the knurled wheels to smoothly open and close the air vents
- 2 Use the lever to change the direction of the airflow

## Ventilation for cooling

Adjust the vent outlets to direct the flow of cool air in your direction, for instance if it has become too hot in the car.

## Draft-free ventilation

Set the vent outlets so that the air flows past you and not straight at you.

## Microfilter

The microfilter removes dust and pollen from the incoming air. The microfilter is changed by your BMW center during routine maintenance work.

## Automatic climate control\*



- |   |   |
|---|---|
| <p>1 Air distribution, manual</p> <p>2 Temperature, left side of passenger compartment</p> <p>3 Maximum cooling</p> <p>4 AUTO program</p> <p>5 Air flow rate, manual</p> <p>6 Automatic recirculated-air control AUC/ Recirculated-air mode</p> | <p>7 Residual heat</p> <p>8 Temperature, right side of passenger compartment</p> <p>9 Windows, defrosting and removing condensation</p> <p>10 Switching cooling function on/off manually</p> <p>11 Rear window defroster</p> <p>12 Air grill for interior temperature sensor – please keep clear and unobstructed</p> |
|---|---|

### Comfortable interior climate

The AUTO program **4** offers the ideal air distribution and air flow rate for almost all conditions. All you need to do is select an interior temperature which is comfortable for you.

The following sections inform you in detail about how to adjust the settings.

Most settings are stored for the remote control currently in use, refer also to Personal Profile settings on page [18](#).

### Adjusting air distribution manually



The air distribution can be switched on and off manually. The air is directed to the windshield, to the upper body area and to the footwell. Automatic air distribution adjustment is deactivated.

You can switch the automatic air distribution back on by pressing the AUTO button. This automatically switches on the cooling function as well.

### Temperature



Set the desired temperatures individually for the driver's and front passenger's sides.

The automatic climate control achieves this temperature as quickly as possible regardless of the season, using maximum cooling or heating power if necessary, and then maintains it.

▶ When you switch between different temperature settings in quick succession, the automatic climate control does not have enough time to achieve the set temperature. ◀

You can achieve maximum heating power with the highest setting, regardless of the outside temperature.

The lowest setting effects continuous cooling.

### Maximum cooling



At outside temperatures above 32 °F / 0 °C and when the engine is running, you obtain a maximum cooling effect as soon as possible.

The automatic climate control goes into recirculated-air mode at the lowest temperature. Air flows at maximum rate from the vents for the upper body area. You should therefore open them for maximum cooling.

## AUTO program



The AUTO program adjusts the air distribution to the windshield and side windows, towards the upper body area and into the footwell for you. The air flow rate and your temperature specifications will be adapted to outside influences as a result of seasonal changes, e.g. sunlight or window condensation.

The cooling is switched on automatically with the AUTO program.

## Convertible program

The Convertible program is active when the convertible top is open. In the Convertible program, the automatic climate control is optimized for driving with the convertible top down. In addition, the air flow rate is increased as vehicle speed increases.

 The effectiveness of the Convertible program can be enhanced considerably by installing the wind deflector. ◀

## Adjusting air flow rate manually



Press the left side of the button to reduce airflow. Press the right side of the button to increase it. You can reactivate the automatic mode for the air flow rate with the AUTO button.

The air flow rate may be reduced or the blower may be switched off entirely to save on battery power. The display remains the same.

## Switching the system on/off

With the blower at its lowest setting, press the left side of the button to switch off the automatic climate control. All displays are cleared except for the rear window defroster if it is switched on.

Press any button except REST or rear window

defroster to reactivate the automatic climate control.

 The recirculated-air mode is switched on when you switch off the automatic climate control. If the air quality deteriorates or the window fogs over, switch the system back on and increase the air volume. ◀

## Automatic recirculated-air control AUC/Recirculated-air mode



Switch on the desired operating mode by pressing this button repeatedly:

- ▷ LED off: outside air flows in continuously.
- ▷ Left-hand LED on, AUC mode: a sensor detects pollutants in the outside air. If necessary, the system blocks the supply of outside air and recirculates the inside air. As soon as the concentration of pollutants in the outside air has decreased sufficiently, the system automatically switches back to outside air supply.
- ▷ Right-hand LED on, recirculated-air mode: the supply of outside air is permanently shut off. The system then recirculates the air currently within the vehicle.

 If condensation starts to form on the inside window surfaces during operation in the recirculated-air mode, you should switch it off while also increasing the air flow rate as required.

The recirculated-air mode should not be used continuously for lengthy periods, otherwise the quality of the air inside the car will gradually deteriorate. ◀

## Via the button\* on the steering wheel

You can use a button on the steering wheel, refer to page 11, to select between the different modes.

## Residual heat



The heat stored in the engine is used to heat the passenger compartment, e.g. while stopped at a school to pick up a child.

The function can be switched on when the following conditions are met:

- ▷ Up to 15 minutes after the engine has been switched off
- ▷ While the engine is at operating temperature
- ▷ As long as battery voltage is sufficient
- ▷ At an outside temperature below 77 °F / 25 °C

The LED is lit when the function is on.

As of radio readiness, you can set the interior temperature, air flow rate and air distribution.

### Windows, defrosting and removing condensation



Quickly removes ice and condensation from the windshield and front side windows.

Switch on the cooling function as well.

### Switching cooling function on/off



The cooling function cools and dehumidifies the incoming air before reheating it as required, according to the temperature setting. This function is only available while the engine is running.

The cooling function helps prevent condensation on the windows or removes it quickly.

Depending on the weather, the windshield may fog over briefly when the engine is started.

The cooling function is automatically switched on along with the AUTO program.

### Rear window defroster



The defroster is switched off automatically after a certain time. Depending on your vehicle's equipment, the upper wires serve as an antenna and are not part of the rear window defroster.

### Ventilation

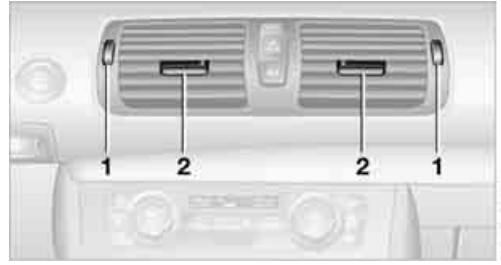

- 1 Use the knurled wheels to smoothly open and close the air vents
- 2 Use the lever to change the direction of the airflow

### Ventilation for cooling

Adjust the vent outlets to direct the flow of cool air in your direction, for instance if it has become too hot in the car.

### Draft-free ventilation

Set the vent outlets so that the air flows past you and not straight at you.

### Microfilter/activated-charcoal filter

The microfilter traps dust and pollen in the incoming air. The activated-charcoal filter provides additional protection by filtering gaseous pollutants from the outside air. Your BMW center replaces this combined filter during routine maintenance.

# Practical interior accessories

## Integrated universal remote control\*

### The concept

The integrated universal remote control can replace as many as three hand-held transmitters for various remote-controlled devices, such as garage doors and gates or lighting systems. The integrated universal remote control registers and stores signals from the original hand-held transmitters.

The signal of an original hand-held transmitter can be programmed on one of the three memory buttons **1**. After this, the programmed memory button **1** will operate the system in question. The LED **2** flashes to confirm transmission of the signal.

Should you sell your vehicle one day, be sure to delete the stored programs beforehand for your safety, refer to page **86**.

 To prevent possible damage or injury, before programming or using the integrated universal remote control, always inspect the immediate area to make certain that no people, animals or objects are within the pivoting or travel range of the device being operated. Comply also with the safety instructions supplied with the original hand-held transmitter. ◀

### Checking compatibility

 If this symbol appears on the package or in the instructions supplied with the original hand-held transmitter, you can assume that the radio remote control device will be compatible with the integrated universal remote control.

For additional information, please contact your BMW center or call: 1-800-355-3515.

You can also obtain information on the Internet at:

[www.bmwusa.com](http://www.bmwusa.com) or  
[www.homelink.com](http://www.homelink.com).

HomeLink is a registered trademark of Johnson Controls, Inc.

### Programming



- 1** Memory buttons
- 2** LED

### Fixed-code hand-held transmitters

- 1.** Switch on the ignition, refer to page **47**.
- 2.** When starting operation for the first time: press the left and right memory buttons **1** for approx. 20 seconds until the LED **2** flashes rapidly. The three memory buttons are cleared.
- 3.** Hold the original hand-held transmitter at a distance of approx. 4 to 12 in/10 to 30 cm from the memory buttons **1**.

 The required distance between the hand-held transmitter and the memory buttons **1** depends on the system of the respective original hand-held transmitter used. ◀

- 4.** Simultaneously press the transmit key on the original hand-held transmitter and the desired memory button **1** on the integrated universal remote control. The LED **2** flashes slowly at first. As soon as the LED **2** flashes rapidly, release both buttons. If the LED **2** does not flash rapidly after approx. 15 seconds, alter the distance and repeat this step.
- 5.** To program other original hand-held transmitters, repeat steps **3** and **4**.

The corresponding memory button **1** is now programmed with the signal of the original hand-held transmitter.

You can operate the device while the ignition is switched off.

 If the device fails to function even after repeated programming, check whether the original hand-held transmitter uses an alternating-code system. To do so, either read the instructions for the original hand-held transmitter or hold down the programmed memory button **1** of the integrated universal remote control. If the LED **2** on the integrated universal remote control flashes rapidly and then remains lit for about two seconds, the original hand-held transmitter uses an alternating-code system. If it uses an alternating-code system, program the memory buttons **1** as described under Alternating-code hand-held transmitters. ◀

## Alternating-code hand-held transmitters

To program the integrated universal remote control, consult the operating instructions for the device to be set. You will find information there on the possibilities for synchronization. When programming hand-held transmitters that employ an alternating code, please observe the following supplementary instructions:

 Programming will be easier with the aid of a second person. ◀

1. Park your vehicle within the range of the remote-controlled device.
2. Program the integrated universal remote control as described above in the section Fixed-code hand-held transmitters.
3. Locate the button on the receiver of the device to be set, e.g. on the drive unit.
4. Press the button on the receiver of the device to be set. After step 4, you have approx. 30 seconds for step 5.
5. Press the programmed memory button **1** of the integrated universal remote control three times.

The corresponding memory button **1** is now programmed with the signal of the original hand-held transmitter.

 If you have any questions, please contact your BMW center. ◀

## Deleting all stored programs

Press the left and right memory buttons **1** for approx. 20 seconds until the LED **2** flashes rapidly: all stored programs are deleted.

## Reassigning individual programs

1. Hold the original hand-held transmitter at a distance of approx. 4 to 12 in/10 to 30 cm from the memory buttons **1**.

 The required distance between the hand-held transmitter and the memory buttons **1** depends on the system of the respective original hand-held transmitter used. ◀

2. Press the desired memory button **1** of the integrated universal remote control.
3. If the LED **2** flashes slowly after approx. 20 seconds, press the transmit key of the original hand-held transmitter. Release both buttons as soon as the LED **2** flashes rapidly. If the LED **2** does not flash rapidly after approx. 15 seconds, alter the distance and repeat this step.



## Digital compass\*

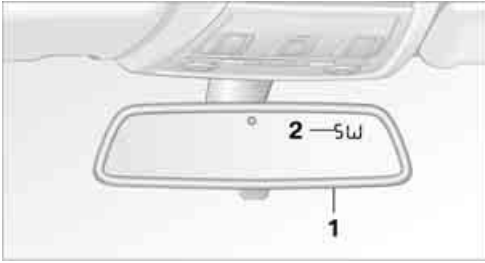

1 Adjustment button

2 Display

The display shows you the main or secondary compass direction in which you are driving.

### Operating principle

You can call up various functions by pressing the adjustment button with a pointed object such as a pen or similar item. The following adjustment options are displayed one after the other, depending on how long you keep the adjustment button pressed:

- ▷ Press briefly: switch display on/off
- ▷ 3 to 6 seconds: set the compass zone
- ▷ 6 to 9 seconds: calibrate the compass
- ▷ 9 to 12 seconds: set left-hand/right-hand steering
- ▷ 12 to 15 seconds: setting the language

### Setting compass zones

Set the compass zone corresponding to your vehicle's geographic location so that the compass can function correctly; refer to the world map with compass zones.

To set the compass zone, press the adjustment button for approx. 3-4 seconds. The number of the compass zone set is shown in the display.

To change the zone setting, briefly press the adjustment button repeatedly until the display shows the number of the compass zone corresponding to your current location.

The compass is operational again after approx. 10 seconds.

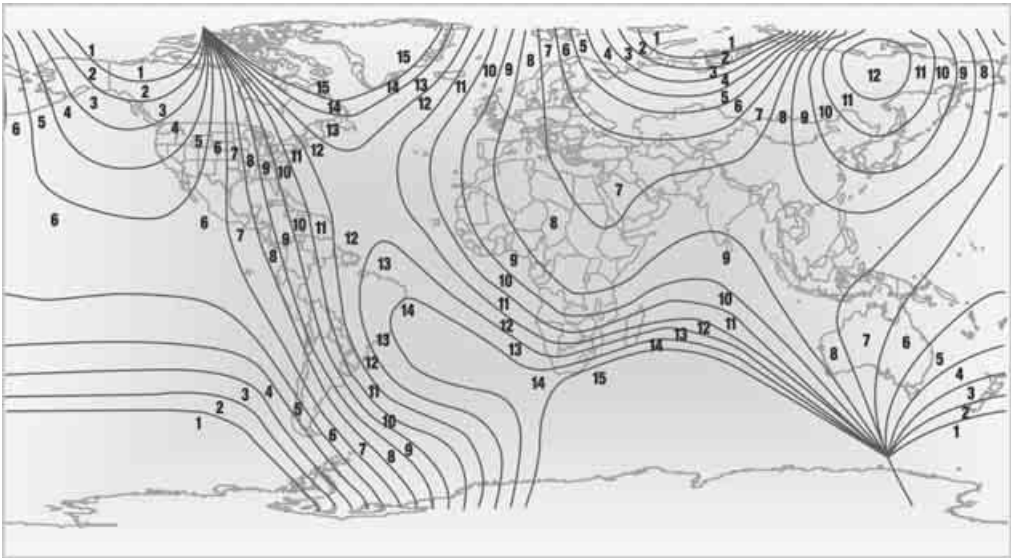

## Calibrating the digital compass

The digital compass must be calibrated in the following situations:

- ▷ An incorrect compass direction is shown.
- ▷ The compass direction shown does not change although the direction of travel does.
- ▷ Not all compass directions are shown.

### Procedure

1. Make sure that no large metal objects or overhead power lines are in the vicinity of your vehicle and that you have enough space to drive in a circle.
2. Set the currently valid compass zone.
3. Convertible: ensure that the convertible top is fully closed.
4. Press the adjustment button for approx. 6-7 seconds to call up C. Then drive in at least one full circle at a speed of no more than 4 mph or 7 km/h.  
If calibration is successful, the display changes from C to a compass direction.
5. Convertible: open the convertible top fully and repeat step 4.

## Setting right-hand/left-hand steering

Your digital compass is factory-set to right-hand or left-hand steering, in accordance with your vehicle.

## Setting the language

You can set the language of the display:

Press the adjustment button for approx. 12-13 seconds. Briefly press the adjustment button again to switch between English, "E", and German, "O".

The setting is automatically saved after approx. 10 seconds.

## Glove compartment

### Opening



Pull the handle.

The light in the glove compartment comes on.

 To prevent injury in the event of an accident while the vehicle is being driven, close the glove compartment immediately after use. ◀

### Closing

Fold cover up.

### Locking

To lock the glove compartment, use the integrated key of the remote control, refer to page 18.

## Center armrest\*

### Storage compartment

The center armrest between the front seats contains a credit card holder and, depending on the equipment version, a compartment or a snap-in adapter\*.



### Opening

Press the button, see arrow.

## Connection for external audio device

You can connect an external audio device such as a CD or MP3 player and play audio tracks over the car's loudspeaker system. You can set the volume and tone by means of the car radio, refer to the separate Owner's Manual for Radio.

### Connecting

Lift up the center armrest.



Connection for audio playback:  
TRS connector 1/8 in/3.5 mm.

To play audio tracks over the car's loudspeaker system, connect the headset or line-out port of the external device to the connector.

## Storage compartments inside the vehicle

Compartments are located next to the steering column\*, on the doors and in the center con-

sole.  
There are nets\* on the front-seat backrests.

### Compartment on the instrument panel\*

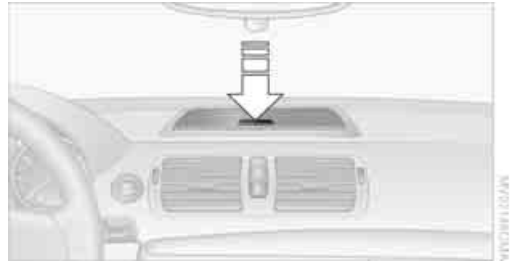

To open: press the button.

### Coupe: clothes hooks

There are clothes hooks in the rear.

**!** Items of clothing hung from the hooks must not obstruct the driver's view. Do not hang heavy objects from the hooks, otherwise they could endanger the car's occupants, e.g. in case of heavy braking or sudden swerving. ◀

### Cup holders\*

**!** Use lightweight and shatterproof containers and do not transport hot beverages, otherwise there is an increased risk of injury in the event of the accident. Do not force containers that are too large into the cup holders, otherwise damage could result. ◀



There are two cup holders in the center console.



You can mount an attachable cup holder\* on the side of the center console.

## Ashtray\*

### Opening



Push the ridge on the cover.

### Emptying



Lift out the insert.

## Lighter

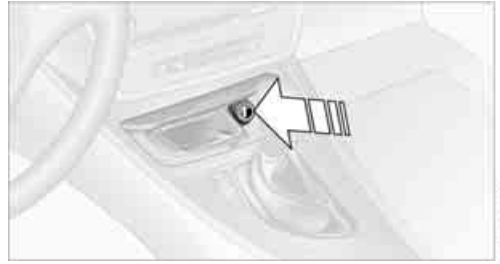

With the engine running or the ignition switched on, press in the cigarette lighter.

The lighter can be pulled out as soon as it pops back out.

 Hold or touch the hot cigarette lighter by the knob only. Holding or touching it in other areas could result in burns. When leaving the car, always remove the remote control so that children cannot operate the cigarette lighter and burn themselves. ◀

## Connecting electrical appliances

In your BMW, when the engine is running or the ignition is switched on, you can use electrical devices such as a hand lamp, car vacuum cleaner, etc., up to approx. 200 watts at 12 volts, as long as one of the following sockets is available. Avoid damaging the socket by attempting to insert plugs of unsuitable shape or size.

### Cigarette lighter socket\*

To access the socket:

Open the ashtray at the front and pull out the lighter to use the socket.

### In the cargo bay\*

To access the socket:

Fold open the cover.

### In the center console

To access the socket, refer to Connection for external audio device on page 89.

## Coupe: through-loading system

### Opening

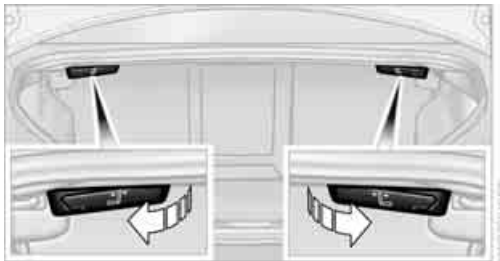

1. To release the rear seat backrest, pull the corresponding lever in the cargo bay.
2. The unlocked rear seat backrest moves forward slightly. Fold the backrest forward by the head restraint.

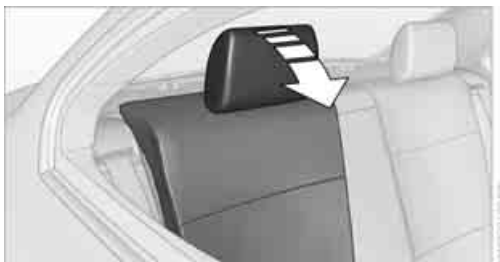

### Closing

Return the rear seat backrest to its upright position and engage it.

 When returning the backrest into its seating position, make sure that the seat's locking mechanism is properly engaged. Otherwise, cargo could be thrown around in the event of sharp braking or swerving and endanger the occupants. ◀

The lashing eyes in the cargo bay provide you with a way to attach cargo bay nets\* or draw straps for securing suitcases and luggage, refer to page 99.

## Convertible: cargo loading

### Enlarging the cargo bay

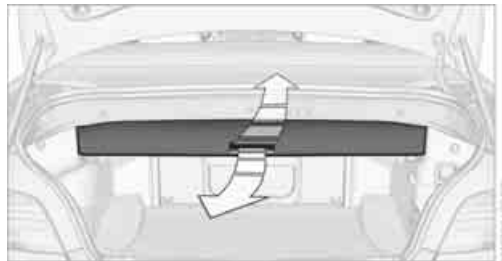

When the convertible top is closed you can enlarge the cargo bay:  
To do so, fold the cargo bay partition upward.

Before opening the convertible top, pull the cargo bay partition down until it engages.

Ensure that pointed objects do not press against the cargo bay partition from below.

 The convertible top can only be opened when the cargo bay partition is folded down. ◀

## Storage compartments inside the cargo bay

Depending on your vehicle's equipment, the following storage spaces can be found in the cargo bay:

- ▷ Rubber strap\* on the left trim panel for securing small objects such as a folding umbrella
- ▷ Net\* for small objects on the right trim panel of the cargo bay
- ▷ Retaining straps\* on cargo bay floor: for securing smaller objects or as an anti-slip surface when you place objects on the straps

The lashing eyes in the cargo bay provide you with a way to attach cargo bay nets\* or draw straps\* for securing suitcases and luggage, refer to page 100.

## Coupe: ski bag\*

The ski bag is designed for safe, clean transport of up to 4 pairs of standard skis or up to 2 snowboards.

With the ski bag you can stow skis with a length of up to 6.6 ft/2.0 m. When skis of 6.6 ft/2.0 m length are loaded, the overall capacity of the ski bag is reduced due to its tapered design.

### Loading

Ensure that the skis are clean when they are loaded into the ski bag. Wrap sharp edges to prevent damage.

1. Fold down the center panel in the rear seat backrest.
2. Press the button, reach into the recess and fold down the cover. To stabilize the cover in the folded-down position, place the center panel underneath it.

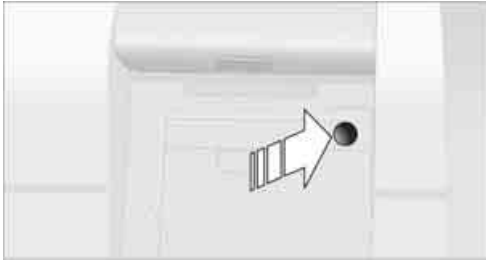

3. Open the Velcro fastener, spread the ski bag between the front seats and insert the skis or snowboards. The zip fastener makes objects in the ski bag easier to reach.
4. Attach the hook of the ski bag retaining strap to the eyelet on the side of the ski bag opening.



### Securing cargo



After loading, secure the ski bag and its contents. Tighten the retaining strap on the tensioning buckle for this purpose.

 Secure the ski bag in the manner described, otherwise it could endanger the car's occupants, e.g. in case of heavy braking or sudden swerving. ◀

To store the ski bag, perform the steps described for loading in reverse order.

### Removing the ski bag

The ski bag can be completely removed, e.g. for faster drying or to allow you to use other inserts.

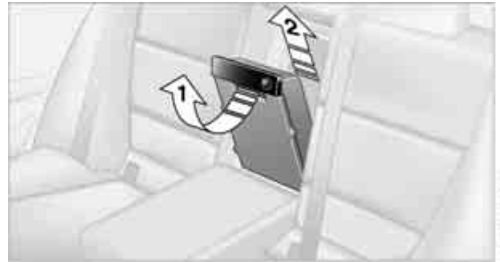

1. Fold down the center panel in the rear seat backrest.
2. Pull the handle, arrow 1.
3. Pull out the insert, arrow 2.

 For more information on the various inserts available, contact your BMW center. ◀

## Convertible: through-loading opening with integrated transport bag\*

The transport bag is designed for safe, clean transport of up to 4 pairs of standard skis or up to 2 snowboards.

With the transport bag you can stow skis up to a length of 6.6 ft / 2.0 m. When skis of 6.6 ft / 2.0 m length are loaded, the overall capacity of the ski bag is reduced due to its tapered design.

 When using the transport bag, it is not permissible to transport passengers in the rear seats. ◀

### Loading

1. Pull the grip in the filler piece of the rear backrest up and take out the filler piece.
2. Place the filler piece onto the seat cushion with the backrest side facing up.

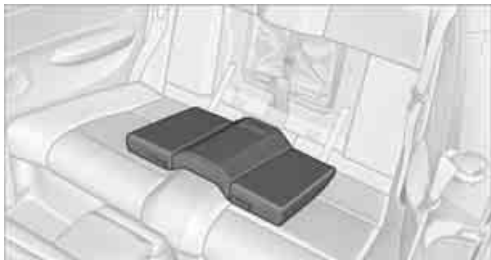

3. In the cargo bay: press the two recesses together and fold down the cover.

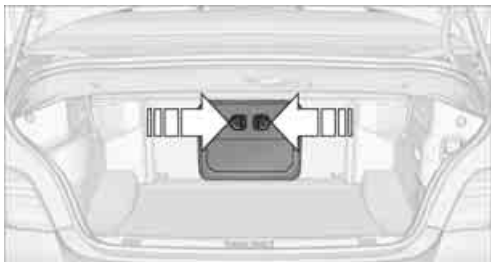

4. Release the strap, lay out the transport bag between the front seats and load it. The zip fastener makes objects in the ski bag easier to reach.



Ensure that the skis are clean when you load them into the transport bag. Wrap sharp edges to prevent damage.

### Securing cargo



After loading, secure the transport bag and its contents. Tighten the retaining strap on the tensioning buckle for this purpose.

 Secure the transport bag in the manner described, otherwise it could endanger the car's occupants, e.g. in case of heavy braking or sudden swerving. ◀

To store the transport bag, perform the steps described for loading in reverse order.







## Driving tips

This section provides you with information useful in dealing with specific driving and operating conditions.

# Things to remember when driving

## Break-in period

Moving parts need breaking-in time to adjust to each other. Please follow the instructions below in order to achieve the optimal service life and economy of operation for your vehicle.

## Engine and differential

Always obey all official speed limits.

### Up to 1,200 miles/2,000 km

Drive at varying engine and road speeds, but do not exceed an engine speed of 4500 rpm or a road speed of 100 mph/160 km/h.

Avoid full-throttle operation and use of the transmission's kick-down mode.

### After driving 1,200 miles/2,000 km

Engine and vehicle speeds can be gradually increased.

## Tires

Due to technical factors associated with their manufacture, tires do not achieve their full traction potential until after an initial break-in period. Therefore, drive cautiously during the first 200 miles/300 km.

## Brake system

Brakes require an initial break-in period of approx. 300 miles/500 km to achieve optimized contact and wear patterns between brake pads and rotors. Drive cautiously during this break-in period.

## Clutch

The function of the clutch reaches its optimal level only after a distance driven of approx. 300 miles/500 km. During this break-in period, engage the clutch gently.

## Following part replacement

The same break-in procedures should be observed if any of the components mentioned above have to be renewed in the course of the vehicle's operating life.

## Saving fuel

The fuel consumption of your vehicle depends on several factors. You can lower fuel consumption and the environmental impact by taking certain measures, adjusting your driving style and having the vehicle serviced regularly.

### Remove any unneeded cargo

Additional weight increases fuel consumption.

### Remove any mounted parts after you have finished using them

Remove unneeded additional mirrors, the roof rack and the rear luggage rack after use. Mounted parts affect the vehicle's aerodynamics and increase fuel consumption.

### Close the windows and glass roof

An open glass roof or window causes higher air resistance and thus increases fuel consumption.

### Check tire inflation pressure regularly

Check the tire inflation pressure at least twice a month and before embarking on a long journey, and correct it if necessary.

Low tire inflation pressure causes higher rolling resistance and thus increases fuel consumption and tire wear.

### Set off immediately

Do not let the engine warm up while the car is still standing, but set off immediately at moderate engine speed. This is the fastest way for the cold engine to reach its operating temperature.

## Drive defensively

Avoid unnecessary acceleration and braking maneuvers. To do so, keep an adequate distance to the forward vehicle. A defensive and smooth driving style keeps fuel consumption down.

## Avoid high engine speeds

Only use first gear when setting off. In second and higher gears, accelerate without hesitation or pauses. When accelerating, shift up before reaching high engine speeds.

When you reach the desired speed, shift into the highest applicable gear and drive with the engine speed as low as possible and at a constant speed.

As a rule: driving at low engine speeds lowers fuel consumption and reduces wear.

## Coasting

When approaching a red light, take your foot off the accelerator and coast to a stop in the highest applicable gear.

On a downhill slope, take your foot off the accelerator and coast in a suitable gear.

The fuel supply is interrupted when coasting.

## Switch off the engine during lengthy stops

Switch off the engine when stopping for lengthy periods, e.g. at traffic lights, railroad crossings or in traffic congestions. You achieve fuel savings even if standing time is as short as approx. 4 seconds.

## Switch off functions you do not need at the moment

Functions such as the air conditioner, seat heating or rear window defroster draw large amounts of power and consume additional fuel. Especially in city traffic and in stop-and-go driving they have a considerable impact. Therefore, switch these functions off when they are not really needed.

## Have the vehicle serviced

Have the vehicle serviced regularly to achieve good economy and a long vehicle life. BMW recommends having the vehicle serviced at a BMW center. Also note the BMW service system, refer to page 118.

## General driving notes

### Close the luggage compartment lid

 Operate the vehicle only when the luggage compartment lid is closed. Otherwise, exhaust fumes could enter the interior of the vehicle. ◀

If the vehicle must be driven with the luggage compartment lid open:

1. Close all windows and the glass roof.
2. Greatly increase the air volume of the heating or automatic climate control system, refer to page 80 or 83.
3. Greatly increase the air volume of the automatic climate control system, refer to page 83.

### Hot exhaust system

 In all vehicles, extremely high temperatures are generated in the exhaust system. Do not remove the heat shields installed in its vicinity, and never apply undercoating to them. When driving, standing at idle and while parking, take care to avoid possible contact between the hot exhaust system and any highly flammable materials such as hay, leaves, grass, etc. Such contact could lead to a fire, with the risk of serious personal injuries and property damage. Do not touch hot exhaust tail pipes. Otherwise there is a risk of burns. ◀

### Hydroplaning

 When driving on wet or slushy roads, reduce road speed. If you do not, a wedge of water can form between tires and road surface. This situation, known as hydroplaning, means that the tire can completely lose contact

with the road surface, so that neither the car can be steered nor the brake be properly applied. ◀  
The risk of hydroplaning increases with declining tread depth on the tires, refer also to Minimum tread depth on page 111.

### Driving through water

 Drive through water on the road only if it is not deeper than 1 ft/30 cm, and then only at walking speed at the most. Otherwise, the vehicle's engine, the electrical systems and the transmission may be damaged. ◀

### Use the parking brake on inclines

 On inclines, do not hold the vehicle for a lengthy period using the clutch; use the parking brake instead. Otherwise greater clutch wear will result. ◀

For more information about the drive-off assistant, refer to page 66.

### Braking safely

Your BMW is equipped with ABS as a standard feature. Applying the brakes fully is the most effective way of braking in situations in which this is necessary. Since the vehicle maintains steering responsiveness, you can still avoid possible obstacles with a minimum of steering effort.

Pulsation of the brake pedal, combined with sounds from the hydraulic circuits, indicate that ABS is in its active mode.

### Driving in wet conditions

When roads are wet or there is heavy rain, briefly exert gentle pressure on the brake pedal every few miles. Monitor traffic conditions to ensure that this maneuver does not endanger other road users. The heat generated in this process helps dry the pads and rotors to ensure that full braking efficiency will then be available when you need it.

### Hills

 To prevent overheating and the resulting reduced efficiency of the brake system, drive long or steep downhill gradients in the

gear in which the least braking is required. Even light but consistent brake pressure can lead to high temperatures, brake wear and possibly even brake failure. ◀

You can increase the engine's braking effect by shifting down, all the way to first gear if necessary. This strategy helps you avoid placing excessive loads on the brake system. Downshifting in manual mode of the automatic transmission, refer to page 50.

 Never drive with the clutch held down, with the transmission in neutral or with the engine switched off; otherwise, engine braking action will not be present or there will be no power assistance to the brakes or steering. Never allow floor mats, carpets or any other objects to protrude into the area around the pedals, otherwise pedal function could be impaired. ◀

### Corrosion on brake rotors

When the vehicle is driven only occasionally, during extended periods when the vehicle is not used at all, and in operating conditions where brake applications are less frequent, there is an increased tendency for corrosion to form on rotors, while contaminants accumulate on the brake pads. This occurs because the minimum pressure which must be exerted by the pads during brake applications to clean the rotors is not reached.

Should corrosion form on the brake rotors, the brakes will tend to respond with a pulsating effect that even extended application will fail to cure.

### When the vehicle is parked

Condensation forms while the automatic climate control is in operation, and then exits under the vehicle. Traces of condensed water under the vehicle are therefore normal.

### Before driving into a car wash

General information on caring for your BMW can be found on page 120.

## With convenient access and automatic transmission

Insert the remote control into the ignition switch.

The engine can be switched off when the selector lever is in position N. Refer also to page 27.

## Cargo loading

 To avoid loading the tires beyond their approved carrying capacity, never overload the vehicle. Overloading can lead to overheating and increases the rate at which damage develops inside the tires. This can ultimately result in a sudden blow-out. ◀

 Make sure that no liquids are spilled or leak from their containers in the cargo bay, as this could result in damage to the vehicle. ◀

## Determining loading limit



1. Locate the following statement on your vehicle's placard\*:

 The combined weight of occupants and cargo should never exceed XXX kg or YYY lbs. Otherwise, overloading can result in damage to the vehicle and unstable driving conditions. ◀

2. Determine the combined weight of the driver and passengers that will be riding in your vehicle.
3. Subtract the combined weight of the driver and passengers from XXX kilograms or YYY pounds.
4. The resulting figure equals the available amount of cargo and luggage load capacity.

For example, if the YYY amount equals 1,400 lbs. and there will be five 150-lb. passengers in your vehicle, the amount of available cargo and luggage load capacity is 650 lbs:

$$1,400 \text{ lbs.} - 750 \text{ lbs.} = 650 \text{ lbs.}$$

5. Determine the combined weight of luggage and cargo being loaded on the vehicle. That weight may not safely exceed the available cargo and luggage load capacity calculated in step 4.
6. If your vehicle will be towing a trailer, part of the load from your trailer will be transferred to your vehicle. Consult the manual for transporting a trailer to determine how this may reduce the available cargo and luggage load capacity of your vehicle.

## Load

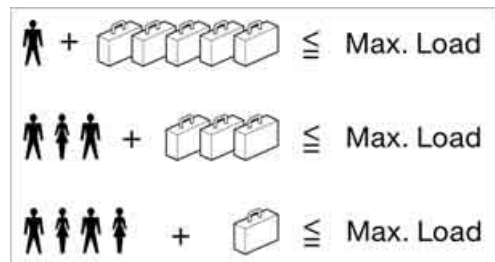

The permissible load is the total of the weight of occupants and cargo/luggage. The greater the weight of the occupants, the less cargo/luggage can be transported.

## Stowing cargo

### Coupe

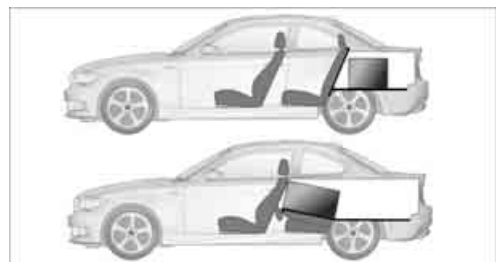

## Convertible

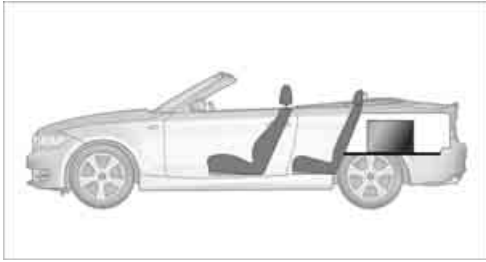

- ▷ Position heavy objects as low and as far forward as possible, ideally directly behind the respective seat backrests.
- ▷ Cover sharp edges and corners.
- ▷ For very heavy cargo when the rear seat is not occupied, secure each safety belt in the opposite buckle.

## Securing cargo



- ▷ Secure smaller and lighter items using retaining straps\*, a cargo bay net\* or draw straps\*.
- ▷ Heavy-duty cargo straps\* for securing larger and heavier objects are available at your BMW center. To attach the cargo straps, there are two lashing eyes, arrows **1**, on the inside wall of the cargo bay. Depending on your vehicle's equipment, there may be two additional lashing eyes, arrows **2**, on the cargo bay sidewalls. Follow the information included with the cargo straps.

**⚠** Always position and secure the cargo as described above, so that it cannot endanger the car's occupants, for example if sudden braking or swerving is necessary. Never exceed either the approved gross vehicle

weight or either of the approved axle loads, refer to page 149, as excessive loads can pose a safety hazard, and may also place you in violation of traffic safety laws.

Heavy or hard objects should not be carried loose inside the car, since they could be thrown around, for example as a result of heavy braking, sudden swerves, etc., and endanger the occupants.

Only attach the cargo straps using the lashing eyes shown in the illustration. Do not secure cargo with the anchors for tether straps, refer to page 45, otherwise these could be damaged. ◀

## Coupe: roof-mounted luggage rack\*

A special rack system is available as an option for your BMW. Comply with the directions given in the installation instructions.

## Mounting points



Fold open the cover.

## Loading roof-mounted luggage rack

Because roof racks raise the vehicle's center of gravity when loaded, they have a major effect on vehicle handling and steering response.

You should therefore always remember not to exceed the approved roof load capacity, the approved gross vehicle weight or the axle loads when loading the rack.

You can find the applicable data under Weights on page 149.

The roof load must be distributed uniformly and should not be too large in area. Heavy items should always be placed at the bottom. Be sure

that adequate clearance is maintained for raising the glass roof, and that objects do not project into the opening path of the luggage compartment lid.

Fasten roof-mounted cargo correctly and securely to prevent it from shifting or falling off during the trip.

Drive smoothly. Avoid sudden acceleration and braking maneuvers. Take corners gently.

## Rear-mounted luggage rack\*

A rear-mounted luggage rack is available as a special accessory for your BMW. Comply with the directions given in the installation instructions.

### Mounting points



The mounting points are located under the protective covers in the bumper.

### Loading the rear-mounted luggage rack

You should always remember not to exceed the approved roof load capacity, the approved gross vehicle weight or the axle loads when loading the rack.

You can find the applicable data under Weights on page 149.



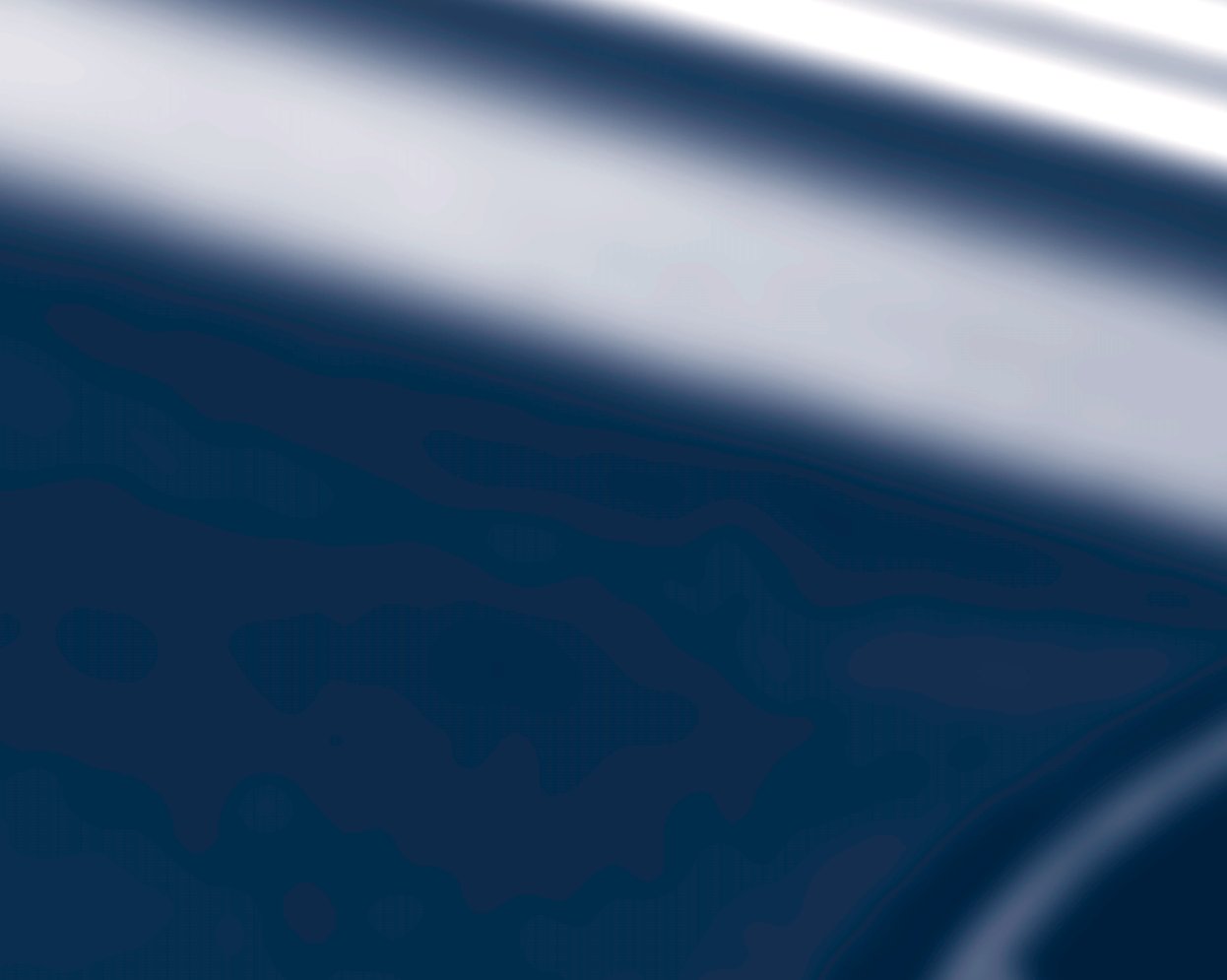







## Mobility

This section helps you maintain your car's mobility by supplying important information on vital topics including fuels and lubricants, wheels and tires, service, maintenance and roadside assistance.

# Refueling

 Always switch off the engine before refueling, otherwise, fuel cannot be added to the tank and a message will be displayed. ◀

 Take all precautionary measures and observe all applicable regulations when handling fuel. Do not carry any spare fuel containers in your vehicle. They can develop a leak and cause an explosion or cause a fire in the event of an accident. ◀

## Fuel filler door

### Opening

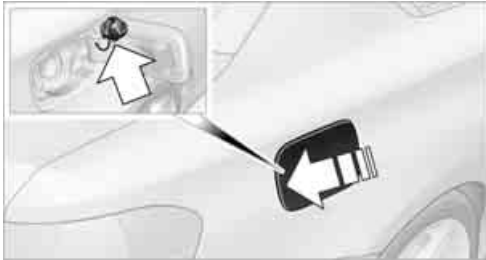

1. Open fuel filler door. To do so, lightly press the rear edge.
2. Turn the gas cap counterclockwise.
3. Place the gas cap in the bracket attached to the fuel filler door.

### Closing

Fit the cap and turn it clockwise until you clearly hear a click.

 Do not pinch the band attached to the cap, otherwise the cap cannot be closed properly and fuel vapors can escape. ◀

 The warning lamp lights up briefly if the gas cap is loose or missing. If this occurs, close the cap correctly.

### Manually releasing the fuel filler door

In the event of a malfunction, you can release the fuel filler door manually:

1. Remove the cover from the right-hand side-wall of the cargo bay.

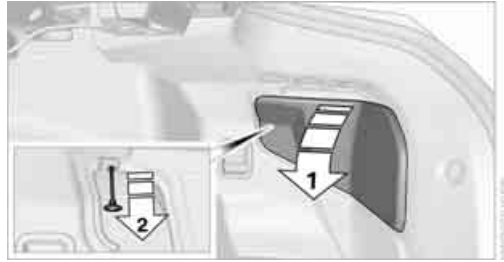

2. Pull the button with the fuel pump symbol down.  
The fuel filler door is released.

### Observe the following when refueling

 When handling fuels, follow the safety instructions provided at filling stations, otherwise there is a risk of personal injury or property damage. ◀

When refueling, insert the filler nozzle completely into the filler pipe. Avoid lifting the filler nozzle while filling the tank, as that would lead to

- ▷ premature pump shutoff
- ▷ reduced efficiency of the fuel-vapor recovery system.

The fuel tank is full when the filler nozzle clicks off the first time.

### Fuel tank capacity

Approx. 14 US gallons/53 liters, including the reserve capacity of 2.1 US gallons/8 liters.

 Refuel as soon as possible once your cruising range falls below 30 miles/ 50 km, otherwise engine functions are not ensured and damage can occur. ◀

### Fuel specifications

 Do not fill the tank with leaded fuel, as this would cause permanent damage to the

catalytic converter.

Do not fill the tank with E85, i.e. fuel containing 85% ethanol, nor with FlexFuel. Otherwise the engine and fuel supply system will be damaged. ◀

## Required fuel

### Super Premium Gasoline/AKI 91

This gasoline is highly recommended.

However, you may also use gasoline with less AKI. The minimum AKI Rating is:

- ▷ 128i: 87
- ▷ 135i: 89

If you use gasoline with this minimum AKI Rating, the engine may produce knocking sounds when starting at high outside temperatures. This has no effect on the engine life.

 Do not use any gasoline below the specified minimum fuel grade. Otherwise the engine could be damaged. ◀

### Use high-quality brands

Field experience has indicated significant differences in fuel quality: volatility, composition, additives, etc., among gasolines offered for sale in the United States and Canada. Fuels containing up to and including 10% ethanol or other oxygenates with up to 2.8% oxygen by weight, that is, 15% MTBE or 3% methanol plus an equivalent amount of co-solvent, will not void the applicable warranties with respect to defects in materials or workmanship.

 The use of poor-quality fuels may result in driveability, starting and stalling problems especially under certain environmental conditions such as high ambient temperature and high altitude.

Should you encounter driveability problems which you suspect could be related to the fuel you are using, we recommend that you respond by switching to a recognized high-quality brand such as gasoline that is advertised as Top Tier Detergent Gasoline.

Failure to comply with these recommendations may also result in unscheduled maintenance.

# Wheels and tires

## Tire inflation pressures

### Information for your safety

It is not merely the tires' service life, but also driving comfort and, to a great extent, driving safety that depend on the condition of the tires and the maintenance of the specified tire pressure.

 Check the tire inflation pressure regularly and correct it, if necessary: at least twice a month and before starting long trips. If you fail to observe this precaution you may be driving on tires with incorrect tire pressures, a condition that can not only compromise your vehicle's driving stability, but also lead to tire damage and the risk of an accident. Do not drive with deflated, i.e. flat tires, except when using Run-Flat Tires. A flat tire will seriously impair your vehicle's handling and braking response. Attempts to drive on a flat tire can lead to loss of control over the vehicle. ◀

### Checking pressure

Only check tire inflation pressure when the tires are cold. This means after a maximum of 1.25 miles/2 km driving or when the vehicle has been parked for at least 2 hours. When tires are warm, the tire inflation pressure is higher.

 After correcting the tire inflation pressure, reinitialize the Tire Pressure Monitor, refer to page 68, or the Flat Tire Monitor, refer to page 66. ◀

### Inflation pressure specifications

The tables below provide all the correct inflation pressures for the specified tire sizes at ambient temperature.

 The inflation pressures apply to the tire sizes approved and tire brands recommended by BMW; a list of these is available from your BMW center. ◀

For correct identification of the right tire inflation pressures, observe the following:

- ▷ Tire sizes for your vehicle
- ▷ Load conditions
- ▷ Maximum allowable driving speed

### Tire inflation pressures for driving up to 100 mph or 160 km/h

For normal driving up to 100 mph or 160 km/h and to achieve optimum driving comfort, adjust pressures to the respective tire inflation pressures listed on the following pages in the columns for traveling speeds up to a maximum of 100 mph or 160 km/h.

These tire inflation pressures can also be found on the driver's-side door post when the driver's door is open.





 The maximum permissible speed for these tire pressures is 100 mph or 160 km/h. Do not exceed this speed, otherwise tire damage and accidents could occur. ◀

### Tire inflation pressures for driving above 100 mph or 160 km/h

 In order to drive at maximum speeds in excess of 100 mph or 160 km/h, adjust pressures to the respective tire inflation pressures listed on the following pages in the columns for traveling speeds including those exceeding 100 mph or 160 km/h. Otherwise tire damage and accidents could occur. ◀



Observe all national and local maximum speed limits, otherwise violations of the laws could occur.

## Coupe: tire inflation pressures for the 128i

Tire size	Pressure specifications in psi/kPa						
	Traveling speeds up to a max. of 100 mph / 160 km/h		Traveling speeds including those exceeding 100 mph / 160 km/h				
All pressure specifications in the table are indicated in psi/kilopascal with cold tires. Cold = ambient temperature							
	195/55 R 16 87 H M+S	32/220	38/260	32/220	35/240	35/240	42/290
	205/55 R 16 91 H M+S	32/220	35/240	32/220	35/240	35/240	42/290
	205/50 R 17 89 H M+S	32/220	35/240	32/220	35/240	35/240	42/290
	Front: 205/50 R 17 89 V	32/220	-	32/220	-	35/240	-
	Rear: 225/45 R 17 91 V	-	35/240	-	35/240	-	42/290
	Front: 215/40 R 18 85 Y	32/220	-	32/220	-	35/240	-
Rear: 245/35 R 18 88 Y	-	36/260	-	35/240	-	42/290	



More details on the permissible load and weights can be found on page [149](#).

## Coupe: tire inflation pressures for the 135i

Tire size	Pressure specifications in psi/kPa						
	Traveling speeds up to a max. of 100 mph / 160 km/h		Traveling speeds including those exceeding 100 mph / 160 km/h				
All pressure specifications in the table are indicated in psi/kilopascal with cold tires. Cold = ambient temperature							
	205/50 R 17 89 H M+S	33/230	36/250	33/230	36/250	38/260	42/290
	Front: 215/40 R 18 85 Y	36/250	-	36/250	-	38/260	-
	Rear: 245/35 R 18 88 Y	-	38/280	-	36/250	-	42/290

More details on the permissible load and weights can be found on page [149](#).

## Convertible: tire inflation pressures for the 128i

Tire size	Pressure specifications in psi/kPa					
	Traveling speeds up to a max. of 100 mph / 160 km/h			Traveling speeds including those exceeding 100 mph / 160 km/h		
All pressure specifications in the table are indicated in psi/kilopascal with cold tires. Cold = ambient temperature						

### without Sports package



205/55 R 16 91 H M+S	32/220	35/240	32/220	35/240	32/220	39/270
205/50 R 17 89 H M+S	32/220	38/260	32/220	35/240	35/240	42/290
Front: 205/50 R 17 89 V	32/220	-	32/220	-	35/240	-
Rear: 225/45 R 17 91 V	-	35/240	-	35/240	-	41/280
Front: 215/40 R 18 85 Y	35/240	-	32/220	-	35/240	-
Rear: 245/35 R 18 88 Y	-	39/270	-	35/240	-	41/280

### with Sports package

205/55 R 16 91 H M+S	32/220	35/240	32/220	35/240	32/220	39/270
205/50 R 17 89 H M+S	32/220	38/260	32/220	35/240	35/240	42/290
Front: 205/50 R 17 89 V	32/220	-	33/230	-	38/260	-
Rear: 225/45 R 17 91 V	-	36/250	-	36/250	-	45/310
Front: 215/40 R 18 85 Y	35/240	-	33/230	-	38/260	-
Rear: 245/35 R 18 88 Y	-	41/280	-	36/250	-	44/300

More details on the permissible load and weights can be found on page [149](#).

## Convertible: tire inflation pressures for the 135i

Tire size	Pressure specifications in psi/kPa						
	Traveling speeds up to a max. of 100 mph / 160 km/h		Traveling speeds including those exceeding 100 mph / 160 km/h				
All pressure specifications in the table are indicated in psi/kilopascal with cold tires. Cold = ambient temperature							
	205/50 R 17 89 H M+S	33/220	38/260	32/220	35/240	36/250	42/290
	Front: 215/40 R 18 85 Y	39/270	-	39/270	-	39/270	-
Rear: 245/35 R 18 88 Y	-	39/270	-	39/270	-	41/280	
with Sports package							
205/50 R 17 89 H M+S	33/220	38/260	32/220	35/240	36/250	42/290	
Front: 215/40 R 18 85 Y	39/270	-	38/260	-	39/270	-	
Rear: 245/35 R 18 88 Y	-	41/280	-	38/260	-	45/310	
More details on the permissible load and weights can be found on page <a href="#">149</a> .							

## Tire identification marks

Knowledge of the labeling on the side of the tire makes it easier to identify and choose the right tires.

### Tire size

e.g. 225/45 R 17 91 V

Nominal width in mm

Aspect ratio in %

Radial belt construction

Rim diameter in inches

Load rating, not on ZR tires

Speed code letter, in front of the R on ZR tires

### Speed code letter

Q = up to 100 mph or 160 km/h

T = up to 118 mph or 190 km/h

H = up to 131 mph or 210 km/h

V = up to 150 mph or 240 km/h

W = up to 167 mph or 270 km/h

Y = up to 186 mph or 300 km/h

### Tire Identification Number

Tires with DOT codes meet the guidelines of the US Department of Transportation.

DOT code:

e.g. DOT xxxx xxx 3408

Manufacturer's code for tire make

Tire size and tire design

Tire age

### Tire age

The manufacturing date of tires is contained in the tire coding: DOT ... 3408 means that the tire was manufactured in week 34 of 2008.

BMW recommends that you replace all tires after 6 years at most, even if some tires may last for 10 years.

## Uniform Tire Quality Grading

Quality grades can be found where applicable on the tire sidewall between tread shoulder and maximum section width. For example:

Tread wear 200 Traction AA  
Temperature A

### DOT Quality Grades

Tread wear  
Traction AA A B C  
Temperature A B C



All passenger car tires must conform to Federal Safety Requirements in addition to these grades. ◀

### Tread wear

The tread wear grade is a comparative rating based on the wear rate of the tire when tested under controlled conditions on a specified government test course. For example, a tire graded 150 would wear one and one-half (1 ½) times as well on the government course as a tire graded 100. The relative performance of tires depends upon the actual conditions of their use, however, and may depart significantly from the norm due to variations in driving habits, service practices and differences in road characteristics and climate.

### Traction

The traction grades, from highest to lowest, are AA, A, B, and C.

Those grades represent the tire's ability to stop on wet pavement as measured under controlled conditions on specified government test surfaces of asphalt and concrete. A tire marked C may have poor traction performance.



The traction grade assigned to this tire is based on straight-ahead braking traction tests, and does not include acceleration, cornering, hydroplaning, or peak traction characteristics. ◀

### Temperature

The temperature grades are A, the highest, B, and C, representing the tire's resistance to the generation of heat and its ability to dissipate



heat when tested under controlled conditions on a specified indoor laboratory test wheel. Sustained high temperature can cause the material of the tire to degenerate and reduce tire life, and excessive temperature can lead to sudden tire failure. The grade C corresponds to a level of performance which all passenger car tires must meet under the Federal Motor Vehicle Safety Standard No. 109. Grades B and A represent higher levels of performance on the laboratory test wheel than the minimum required by law.

 The temperature grade for this tire is established for a tire that is properly inflated and not overloaded. Excessive speed, underinflation, or excessive loading, either separately or in combination, can cause heat buildup and possible tire failure. ◀

## RSC – Run-Flat Tires

You will recognize Run-Flat Tires by a circular symbol containing the letters RSC on the side of the tire, refer to page 112.

## M+S

Winter and all-season tires. These have better winter properties than summer tires.

## XL

Designation for specially reinforced tires.

## Tire condition

Inspect your tires frequently for tread wear, signs of damage and for foreign objects lodged in the tread. Check the tread depth.

### Minimum tread depth

The tire tread depth should not be below 1/8 in/ 3 mm. At tread depths below 1/8 in/3 mm there is an increased risk of high-speed hydroplaning, even when only small amounts of water are present on the road surface.

The tread depth should not drop below 1/8 in/ 3 mm, although, for example, European legislation only specifies a minimum tread depth of

1/16 in/1.6 mm. At tread depths below 1/8 in/ 3 mm there is an increased risk of high-speed hydroplaning, even when only small amounts of water are present on the road surface.

When winter tires wear down past a tread depth of 1/6 in/4 mm, they become perceptibly less suitable for winter conditions. In the interest of safety, new tires should be installed.

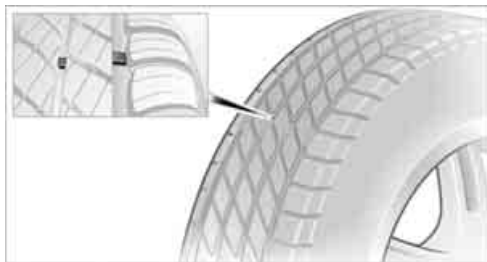

Wear indicators in the base of the tread groove are distributed around the tire's circumference; the letters TWI, for Tread Wear Indicator, on the tire's sidewalls identify tires that incorporate these wear indicators. Once the tire tread has worn down to the wear indicators, the tire has worn to a depth of 1/16 in/1.6 mm.

## Wheel/tire damage

Please note that low-profile tires cause wheels, tires and suspension parts to be more susceptible to road hazard and consequential damages.

Unusual vibrations encountered during normal vehicle operation can indicate tire failure or some other vehicle defect. This can, for example, be caused by driving over curbs. The same applies to any other abnormal road behavior, such as pulling severely to the right or left.

 In these cases, reduce speed immediately and have wheels and tires thoroughly checked. To do so, drive carefully to the nearest BMW center or tire shop that works according to BMW repair procedures with correspondingly trained personnel. If necessary, have the vehicle towed there. Otherwise, tire damage can pose a lethal hazard to vehicle occupants and other road users. ◀

## Tire age

For various reasons, such as the development of brittleness, BMW recommends tire replacement after no more than 6 years, regardless of the actual wear of the tires.

The manufacturing date of tires is contained in the tire coding:

DOT ... 3408 means that the tire was manufactured in week 34 of 2008.

## Run-Flat Tires



The symbol identifying Run-Flat Tires is a circle with the letters RSC on the sidewall.

Run-Flat Tires comprise a conditionally self-supporting tire and a special rim. The reinforcement in the sidewalls ensures that the tire can continue to be used subject to certain restrictions, even if depressurized.

For information on continuing to drive with a flat tire, refer to Indication of a flat tire on page 67.

## New wheels and tires

 Have new wheels and tires installed only by your BMW center or tire shop that works according to BMW repair procedures with correspondingly trained personnel. If this work is not carried out properly, there is a danger of subsequent damage and related safety hazards. Make sure that the new wheels are balanced. ◀

## Retreaded tires

 BMW recommends that you do not use retreaded tires, since driving safety may

be impaired. The causes for this include potentially different tire casing structures and often wide variations in tire age, which can result in a limited service life. ◀

## Correct wheels and tires

When mounting new tires or changing over from summer to winter tires and vice versa, mount Run-Flat Tires for your own safety. In the event of a flat, no spare wheel is available. Your BMW center will be glad to advise you.

 BMW recommends that you use only wheel and tire combinations that BMW has tested and approved for your particular vehicle. Variations in factors such as manufacturing tolerances mean that even wheels and tires with identical official size ratings could actually have different dimensions, which could lead to body contact and thus to severe accidents. If non-approved wheels and tires are used, BMW cannot evaluate their suitability, and therefore cannot guarantee their driving safety. ◀

You can inquire about the right wheel/tire combination at your BMW center.

The correct combination of wheels and tires is also necessary to ensure reliable operation of various vehicle systems such as ABS, DSC or FTM.

To maintain good handling and vehicle response, use only tires of a single brand and tread configuration. After a tire has been damaged, mount the previous wheel and tire combination again as soon as possible.

## Wheels with Tire Pressure Monitor TPM electronics

When mounting new tires or changing over from summer to winter tires, or vice versa, only use wheels with TPM electronics; otherwise the Tire Pressure Monitor may not be able to detect a puncture, refer to page 69. Your BMW center will be glad to advise you.

## Recommended tire brands

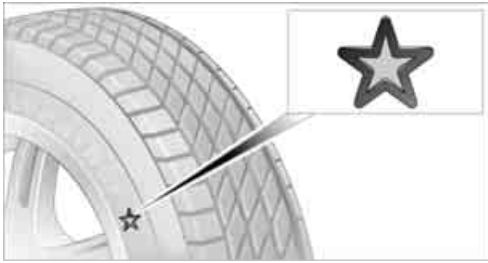

Certain makes of tire are recommended by BMW for each tire size. They are marked with a clearly visible BMW designation on the sidewall of the tire.

When properly used, these tires meet the highest standards in terms of safety and handling characteristics.

## Special characteristics of winter tires

BMW recommends winter tires for winter roads or at temperatures below +45°F /+ 7°C.

Although all-season M+S tires provide better winter traction than summer tires, they generally fail to provide the same levels of cold-weather performance as winter tires.

## Pay attention to speed



Always comply with the speed limit for the winter tires mounted on your car; failure to do so could result in tire damage and accidents. ◀

If the car is capable of speeds higher than that permitted for the winter tires, a label stating the maximum permitted speed for the mounted tires must be displayed in your field of view. Specialist tire dealers and your BMW center can supply these labels.

## Storage

Store wheels and tires in a cool, dry place with as little exposure to light as possible. Always protect tires against all contact with oil, grease and fuels.

Do not exceed the maximum tire inflation pressure indicated on the sidewall of the tire.

## Swapping wheels between axles

BMW advises against swapping wheels between the front and rear axles, even if all tires have the same size, as this could impair driving characteristics. If the tires are of mixed sizes, swapping wheels between the axles is not permissible.

## Snow chains\*

Only certain fine-link snow chains have been tested by BMW, classified as safe for use and recommended. Consult your BMW center for more information. Snow chains must be mounted in pairs and on the rear wheels only. Observe the manufacturer's instructions when mounting snow chains. Do not exceed a speed of 30 mph/50 km/h with chains.



Do not initialize the Flat Tire Monitor if snow chains are mounted, otherwise the instrument might issue an incorrect reading. When driving with snow chains, you may find it helpful to activate DTC temporarily, refer to page 65. ◀

# Under the hood

**!** Do not work on the car unless you possess the necessary technical knowledge. If you are unfamiliar with the statutory guidelines, have any work on the vehicle performed only by a BMW center or by a workshop that work according to BMW repair procedures with correspondingly trained personnel. If this work is not carried out properly, there is a danger of subsequent damage and related safety hazards. ◀

## Hood

### Releasing

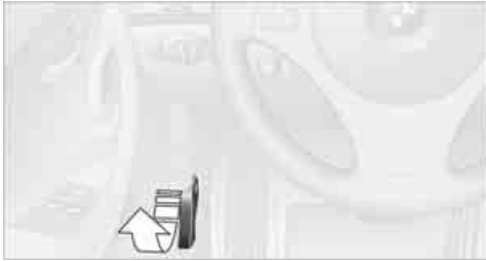

Pull the lever.

### Opening



**!** To avoid damage, make sure that the wiper arms are against the windshield before you open the engine compartment. Do not open the engine hood before the engine has cooled down, otherwise injuries may result. ◀

Press the release handle and open the hood.

### Closing

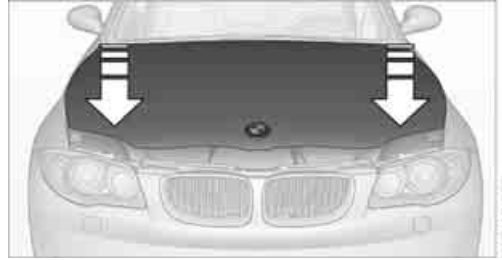

Close the hood from a height of approx. 16 in/ 40 cm with momentum. It must be clearly heard to engage.

**!** Make sure that the closing path of the hood is clear, otherwise injuries may result.

If you see any signs while driving your vehicle that the hood is not completely closed, stop at once and close it securely. ◀

## Important parts of the engine compartment

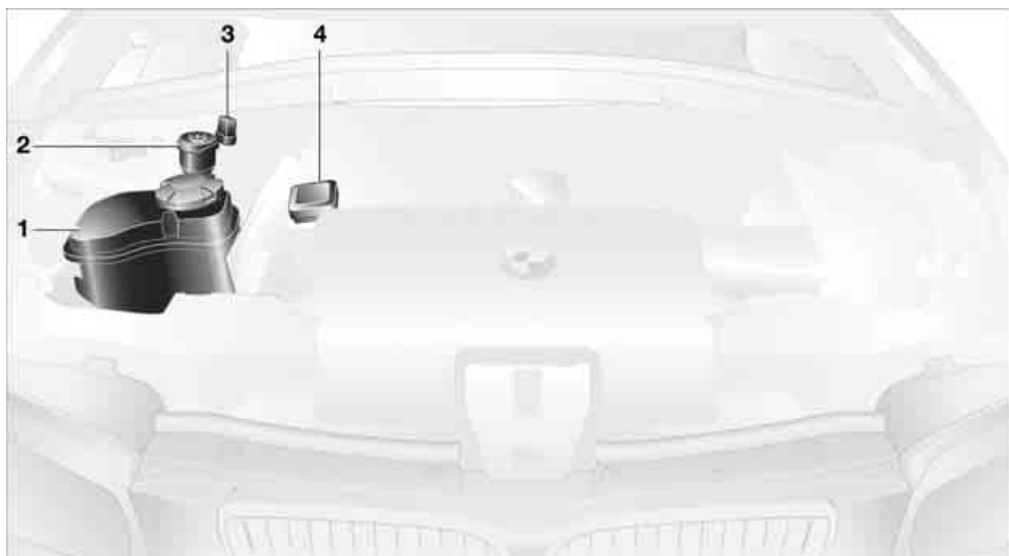

- 1 Expansion tank for coolant, refer to page 117
- 2 Washer fluid filler neck for headlamp cleaning system and window washer system, refer to page 53
- 3 Jump-starting connection, refer to page 131
- 4 Fluid filler neck for engine oil, refer to Adding engine oil, page 116

## Engine oil

The engine oil consumption is dependent on driving style and driving conditions.

### Checking oil level

Your car is equipped with an electronic oil-level monitor.

For a precise measurement and display of the oil level, it is necessary that the engine be at operating temperature, i.e. after uninterrupted driving for at least approx. 6.5 miles/10 km. You can have the oil level displayed while you are driving, or while the vehicle is at a standstill on a level surface and the engine is running.

You can have the oil level reading displayed in the instrument cluster.



1. Push button 1 in the turn indicator lever up or down repeatedly until the appropriate symbol is shown in the display, accompanied by the word "OIL".
2. Press button 2.  
The oil level is checked and the reading displayed.

## Possible displays



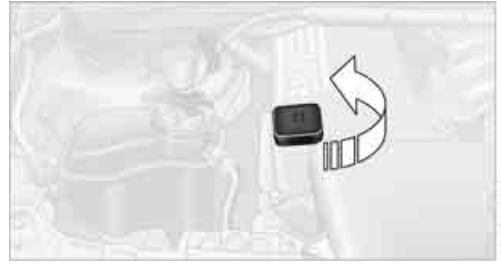

- 1 Oil level OK
- 2 Oil level is being checked.  
This can take about 3 minutes if the car is at a standstill on a level surface, or about 5 minutes while the car is on the move.
- 3 Oil level down to minimum:  
Add engine oil as soon as possible, but no more than 1 US quart/1 liter, refer also to Adding engine oil on page 116.
- 4 Oil level is too high.  
 Too much oil will harm the engine. Have the vehicle checked without delay. ◀
- 5 The oil level sensor is defective.  
Do not add engine oil. You can continue your journey. Note the newly calculated distance remaining to the next oil service, refer to page 118. Have the system checked as soon as possible.

## Adding engine oil



Do not add 1 US quart/1 liter of engine oil until the following warning lamp lights up in the instrument cluster or the oil level display reads "+1l".



-  Add oil within the next 125 miles/200 km, otherwise the engine could be damaged. ◀
-  Keep oils, greases, etc. out of the reach of children and comply with the relevant warnings on the containers. Otherwise, health hazards may result. ◀

## Oil change

Have oil changed only at your BMW center or at a workshop that works according to BMW repair procedures with correspondingly trained personnel.

## Specified engine oils

The quality of the engine oil selected has critical significance for the operation and service life of an engine. BMW continuously approves specific oils after confirming their suitability for use in its vehicles with extensive testing.

-  Do not use oil additives as these may cause engine damage. ◀

Only use approved BMW High Performance Synthetic Oil.

If BMW High Performance Synthetic Oil is not available, you can add small quantities of other synthetic oils in between oil changes. Only use oils with the API SM specification or higher.

 Your BMW center will be glad to answer any questions regarding BMW High Performance Synthetic Oil or approved synthetic oils. ◀

You can also call BMW of North America at 1-800-831-1117 or visit the website [www.bmwusa.com](http://www.bmwusa.com) to obtain this information.

### Viscosity ratings

Viscosity is a measure of an oil's flow rating and is categorized in SAE classes.

Selecting the appropriate SAE class depends on the regional climatic conditions in which you normally drive your BMW.

 Approved oils belong to the 0W-40, 0W-30, 5W-40 and 5W-30 SAE classes. ◀

These oils can be used for driving at all outside temperatures.

BMW recommends 

## Coolant

 Do not add coolant to the cooling system when the engine is hot. Escaping coolant can cause burns. ◀

Coolant consists of half water and half additive. Not all commercially available additives are suitable for your BMW. Ask your BMW center for suitable additives.

 Only use suitable additives, otherwise engine damage may result. Because additives are harmful to your health, it is important to follow the instructions on the containers. ◀

 Comply with the appropriate environmental protection regulations when disposing of coolant additives. ◀

### Checking coolant level

1. Do not open the engine hood before the engine has cooled down.
2. Turn the cap of the expansion tank a little counterclockwise to allow any accumulated pressure to escape, then continue turning to open.
3. The coolant level is correct if it is between the maximum and minimum marks in the filler neck, refer also to the diagram next to the filler neck.

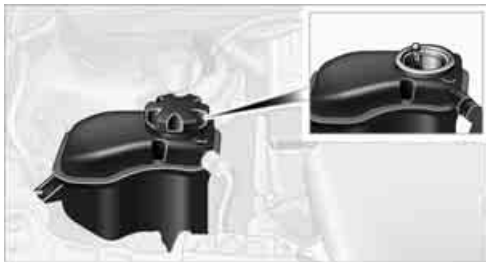

4. If the coolant is low, slowly add coolant up to the specified level; do not overfill.
5. Turn the cap until there is an audible click.
6. Have the reason for the coolant loss eliminated as soon as possible.

# Maintenance

## BMW Maintenance System



The BMW Maintenance System supports the preservation of the traffic and operating safety of your BMW. The objective is to optimize efforts with respect to minimal vehicle maintenance costs.

If and when you come to sell your BMW, a comprehensive record of servicing will prove a significant benefit.

### Condition Based Service CBS

Sensors and special algorithms take the different driving conditions of your BMW into account. Condition Based Service uses this to determine the current and future service requirements. By letting you define a service and maintenance regimen that reflects your own individual requirements, the system builds the basis for trouble-free driving.

In the instrument cluster, you can have the remaining times or distances for selected maintenance tasks and any legally prescribed dates displayed, refer to page 61:

- ▷ Engine oil
- ▷ Brake pads: separately for front and rear
- ▷ Brake fluid
- ▷ Vehicle check
- ▷ Legally mandated inspections depending on local regulations

### Service data in the remote control

Your vehicle continuously stores service-requirement information in the remote control while you are driving. Your BMW Service Advisor can read out this data from the remote control unit, and propose an optimized maintenance approach. Whenever you take your car in for servicing you should therefore hand your BMW Service Advisor the remote control unit that you last used.

 Make sure that the date in the instrument cluster is always set correctly, refer to page 62; otherwise the effectiveness of Condition Based Service CBS is not assured. ◀

### Service and Warranty Information Booklet for US models and Warranty and Service Guide Booklet for Canadian models

Please consult your Service and Warranty Information Booklet for US models and Warranty and Service Guide Booklet for Canadian models for additional information on service requirements.

 BMW recommends that you have service and repair operations performed at your BMW center.

Take the time to ensure that these service procedures are confirmed by entries in your vehicle's Service and Warranty Information Booklet for US models and Warranty and Service Guide Booklet for Canadian models. These entries verify that your vehicle has received the specified regular maintenance. ◀



## Socket for On-Board Diagnosis OBD

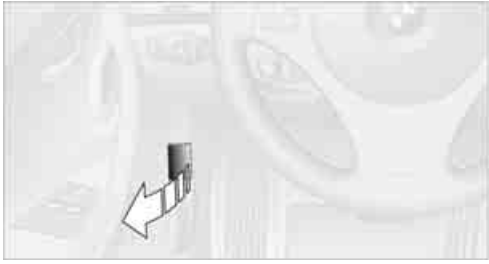

Primary components that make up exhaust emissions can be checked by a device via the OBD socket.

This socket is located on the driver's side to the left, on the bottom of the instrument panel underneath a cover.

## Exhaust emission values

**SERVICE ENGINE SOON** The warning lamp lights up: The exhaust emission values have worsened. Have the car checked as soon as possible.



Canadian models display this warning lamp.

The lamp flashes under certain conditions. This indicates excessive misfiring in the engine. If this happens, you should reduce your speed and visit your nearest BMW center as soon as possible. Severe engine misfiring can quickly lead to serious damage of emissions-related components, especially the catalytic converter.



The warning lamp comes on if the gas cap is not properly tightened and the OBD system assumes that fuel vapor is escaping. If the gas cap is then tightened, the warning lamp should go out within a few days.

## Event data recorders

Your vehicle may be equipped with one or several measuring or diagnostic modules or a device for recording or sending certain vehicle data or information. In addition, if you have

signed a service contract for BMW Assist, certain vehicle data may be transmitted or recorded in order to facilitate the corresponding services.

# Care

## Care products

Regular cleaning and care contributes significantly to the value retention of your BMW.

BMW recommends cleaning and caring for your vehicle with products that are approved by BMW for this purpose.

Your BMW center will be happy to advise you on the products and services available for cleaning and caring for your BMW.

 Original BMW CareProducts have been material tested, laboratory checked and proven in the field, and offer optimal care and protection for your vehicle. ◀

 Do not use cleaners that contain alcohol or solvents as these may result in damage. ◀

 Cleaning agents can contain substances that are dangerous or hazardous to your health. Therefore, follow the warning and safety instructions on the packaging. When cleaning inside the vehicle, always open the doors or windows of the vehicle. In enclosed areas, provide for sufficient ventilation. Only use products designed for cleaning vehicles. ◀

## Exterior care

### Washing the vehicle

 Especially during the winter months, ensure that the vehicle is washed more frequently. Heavy soiling and road salt can lead to vehicle damage. ◀

 After washing the vehicle, apply the brakes briefly to dry them, otherwise water can reduce braking efficiency over the short term and brake discs can corrode. ◀

### Automatic car washes

Preference should be given to cloth car washes.

 Do not use high-pressure car washes, otherwise water may drip into the vehicle around the windows. ◀

Before driving into a car wash, ensure that it is suitable for your BMW. Check the following:

- ▷ Dimensions of your vehicle, refer to page 147.
- ▷ If necessary: fold in the exterior mirrors, refer to page 42
- ▷ Maximum permissible tire width
- ▷ In convertibles, do not treat the convertible top with wax. Ensure that a program is available that does not apply wax or is designed specifically for convertibles.

Preparations before driving into an automatic car wash:

- ▷ Unscrew the rod antenna\*.
- ▷ Deactivate the rain sensor\* to prevent unintentional wiping.
- ▷ Remove additional attachments, e.g. spoiler or telephone antennas, if there is a possibility that they could be damaged.

### Automatic transmission

Before driving into an automatic car wash, perform the following steps to ensure that the vehicle can roll:

1. Insert the remote control, even with convenient access, into the ignition lock.
2. Engage transmission position N.
3. Release the parking brake.
4. Switch off the engine.
5. Leave the remote control in the ignition lock so that the vehicle can roll.

### Steam jets / high-pressure washers

 When using steam jets or high-pressure washers, ensure that you maintain sufficient clearance to the vehicle and do not exceed a temperature of 140 °F / 60 °C. Insufficient clearance or excessive pressure or

temperature can lead to component damage or water penetration. Follow the operating instructions for the steam jet or high-pressure washer. ◀

 When using high-pressure washers, do not spray against the sensors and cameras, e.g. of the Park Distance Control or Rear View Camera, for an extended period and maintain a distance of at least 12 in/30 cm. ◀

## Manual car wash

When washing the vehicle by hand, use large quantities of water and car shampoo if necessary. Clean the vehicle with a sponge or washing brush, applying light pressure only.

 Before cleaning the windshield, deactivate the rain sensor or switch off the ignition to prevent unintentional activation of the wipers. ◀

 Observe local regulations pertaining to washing vehicles by hand. ◀

## Headlamps

Do not rub them dry and do not use abrasive or corrosive cleaning agents.

Remove contamination, such as insects, by soaking with shampoo or insect remover and then rinsing with plenty of water.

Thaw ice with a windshield de-icer and do not use an ice scraper.

## Windows

Clean the inside and outside surfaces of the windows and the mirrors with window cleaner.

 Do not clean the mirrors with cleaners containing quartz. ◀

## Wiper blades

Clean with soapy water and replace regularly to avoid streaking.

 Wax and preservative residue and contamination on the window can lead to streaking when operating the windshield wipers, leading to premature wear of the wiper blades and causing the rain sensor to malfunction. ◀

## Convertible top care

The appearance and life of the convertible top depend on proper care and operation.

Follow these instructions:

- ▶ Do not fold the convertible top into the convertible top box when the top is wet or frozen, as this may cause water spots, mold stains or chafed areas.
- ▶ If water spots occur on the inside headliner despite precautions, remove them using a microfiber cloth and interior cleaner.
- ▶ If the vehicle is parked in enclosed areas for extended periods, ensure that there is sufficient ventilation.
- ▶ Remove bird droppings immediately, as their corrosive ingredients attack the convertible top and damage the rubber seals.

 To remove stains from the convertible top, do not use stain removers, paint thinners, solvents, benzene or similar substances. These substances may damage the rubber parts. Improper care and cleaning may cause the convertible top and convertible top seams to become leaky. ◀

To remove heavy soiling, use a special convertible top cleaner.

Follow the manufacturer's instructions for use.

After washing the convertible top three to five times, treat it with an impregnating agent.

## Paintwork care

Regular care contributes to value retention and protects the paintwork against the long-term effects of damaging substances.

Region-specific environmental influences can damage the vehicle paintwork. Therefore, it is important to adapt the frequency and scope of car care accordingly.

Immediately remove very aggressive substances, e.g. spilled fuel, oil, grease, tree resin or bird droppings, to prevent damage to the paintwork.

## Repairing paintwork damage

 Immediately repair scratches or similar damage, such as that caused by stones hitting the vehicle, where necessary to prevent rusting. ◀

BMW recommends having paintwork damage repaired by a professional paint repair workshop according to BMW specifications using original BMW paint materials.

## Preservation

A preservation treatment is necessary when water no longer beads off of the clean paintwork surface. Only use products for paintwork preservation that contain carnauba or synthetic waxes.

## Rubber seals

Treat only with water or rubber care products.

 Do not use silicon-containing care products on rubber seals, otherwise noise and damage could occur. ◀

## Chrome parts

Carefully clean vehicle parts, such as the radiator grill, door handles or window frames, with copious quantities of water and a shampoo additive. For additional treatment, use a chrome polish.

## Light-alloy wheels

For technical reasons, dust is generated during braking that is deposited on the light-alloy wheels. Remove the dust regularly using acid-free rim cleaner.

 Do not use aggressive, acidic, strongly alkaline and abrasive cleaning agents or steam jets over 140 °F /60 °C, otherwise damage may occur. ◀

## Outside sensors / cameras

 Keep the sensors and cameras on the outside of the vehicle, e.g. those of Park Distance Control, clean and free of ice to ensure that they remain fully functional. ◀

## Interior care

### Upholstery / cloth trim

Vacuum regularly with a vacuum cleaner to remove superficial dirt.

To treat severe stains, e.g. from beverages, use a soft sponge or lint-free microfiber cloth in combination with suitable interior cleaners. Follow the instructions on the packaging.

 Clean the upholstery down to the seams using a sweeping motion. Avoid strong rubbing. ◀

 Opened Velcro fasteners on pants or other articles of clothing can damage the seat covers. Ensure that Velcro fasteners are closed. ◀

### Leather / leather trim

 The leather used by BMW is a high quality natural product. Slight irregularities in the leather are a typical characteristic of natural leather. ◀

Dust and road grit in the pores and folds of the leather have an abrasive effect, leading to increased wear and causing the leather surface to become brittle prematurely. Therefore, frequently clean the leather of dust using a cloth or vacuum cleaner.

In particular, ensure that light-colored leather is cleaned regularly as it has a tendency to soil more easily.

Treat the leather twice a year using a leather lotion as dirt and grease will gradually attack the leather's protective layer.

### Carpets / cargo bay

You can vacuum the carpets and floor mats or clean them with interior cleaner if heavily soiled.

The floor mats can be removed for cleaning. When replacing the mats, ensure that the seat rails do not extend over the floor mats, as this may damage the mats.

Lint on the floor mats occurs for technical reasons and can be removed by vacuuming repeatedly.

## Interior plastic parts

- ▷ Imitation leather surfaces
- ▷ Lamp glasses
- ▷ Display pane of instrument cluster
- ▷ Matt parts

Clean with water and solvent-free plastic cleaner if necessary.

## Fine wood parts

Clean fine wood trim and fine wood parts with a damp cloth. Wipe dry with a soft cloth.

## Safety belts



Do not clean with cleaning agents as these may destroy the fabric. ◀

## Interior sensors / cameras

To clean interior sensors and cameras, e.g. of the High-Beam Assistant, use a lint-free cloth moistened with glass cleaner.

## Displays

To clean the displays, e.g. of the radio or instrument cluster, use a display cleaning cloth or a soft, non-abrasive, lint-free cloth.



Avoid applying excessive pressure when cleaning the displays, otherwise damage may occur. ◀



Do not use chemical or abrasive household cleaning agents. Keep all types of fluid away from the device. Otherwise, surfaces or electrical components may be corroded or damaged. ◀

## CD/DVD drives



Do not use a cleaning CD, as it may damage parts of the drive. ◀

## Vehicle storage

If your vehicle is to be decommissioned for longer than three months, your BMW center or a workshop that operates according to BMW specifications will be glad to advise you.

# Replacing components

## Onboard tool kit

The onboard tool kit is stored below the floor mat in the cargo bay.

## Wiper blades

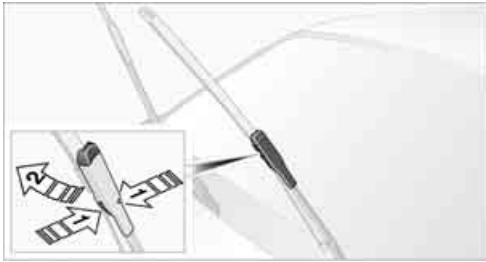

1. Fold out the wiper arm and hold it.
2. Press together the locking spring, arrows 1, and fold out the wiper blade, arrow 2.
3. Take the wiper blade out of the catch mechanism, pulling the blade toward the front.

 To avoid damage, make sure that the wiper arms are against the windshield before you open the engine compartment. ◀

## Lamps and bulbs

Lamps and bulbs make an essential contribution to vehicle safety. They should, therefore, be handled carefully. BMW recommends having your BMW center perform any work that you do not feel competent to perform yourself or that is not described here.

 Never touch the glass of new bulbs with your bare fingers, as even minute amounts of contamination will burn into the bulb's surface and reduce its service life. Use a clean tissue, cloth or something similar, or hold the bulb by its base. ◀

You can obtain a selection of replacement bulbs at your BMW center.

 When working on electrical systems, always begin by switching off the consumer in question, otherwise short-circuits could result. To avoid possible injury or equipment damage when replacing bulbs, observe any instructions provided by the bulb manufacturer. ◀

 If the routine for changing a particular bulb is not described here, please contact your BMW center or a workshop that works according to BMW repair procedures with correspondingly trained personnel. ◀

## Light-emitting diodes LED

Light-emitting diodes installed behind translucent lenses serve as the light source for many of the controls and displays in your vehicle. These light-emitting diodes, which operate using a concept similar to that applied in conventional lasers, are officially designated as Class 1 light-emitting diodes.

 Do not remove the covers or expose the eyes directly to the unfiltered light source for several hours, otherwise this could cause irritation to the retina. ◀

## Xenon lamps\*

These bulbs have a very long service life and are highly unlikely to fail. If a xenon bulb fails nevertheless, switch on the fog lamps and continue the journey with great care, provided that local legislation does not prohibit this.

 Have any work on the xenon lamp system, including bulb replacements, performed only by a BMW center or a workshop that works according to BMW repair procedures with correspondingly trained personnel. Otherwise, if such work is carried out improperly, the high voltage in the system presents the danger of fatal injuries. ◀

## Removing the headlamp cover

1. Pull the wire brackets over the notches, see arrows, and fold to the side.

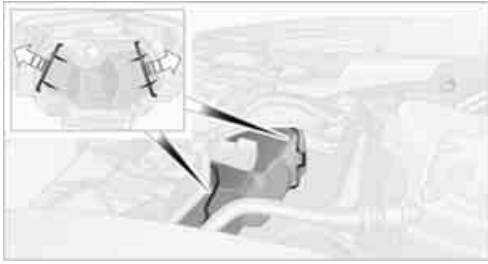

2. Fold away the headlamp cover.

**⚠** Be careful when attaching the headlamp cover and ensure that both wire brackets are securely in place, otherwise leaks could occur and cause damage to the headlamp system. ◀

Attach the headlamp cover in reverse order.

## Halogen headlamps

### Halogen low beams and high beams

H7 bulb, 55 watts

**⚠** Always wear gloves and eye protection; the atmosphere within the H7 bulb is pressurized. Otherwise there is a risk of injury if the bulb is damaged. ◀

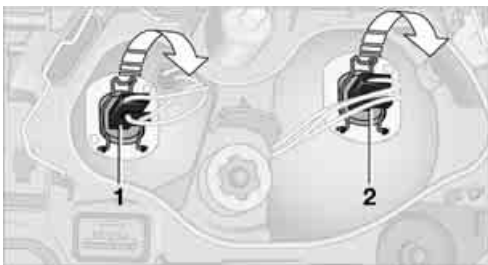

The figure shows the right-hand headlamp.

- 1 High beams
  - 2 Low-beam headlamps
1. Remove the headlamp cover.
  2. Fold down the holding bracket.
  3. Remove and replace the bulb.

4. Reattach the bulb holder with the notch at the top.
5. Fold the holding bracket back up and let it snap into place.
6. Attach the headlamp cover.

## Parking lamps, roadside parking lamps

W5W bulb, 5 watts

1. Remove the headlamp cover.

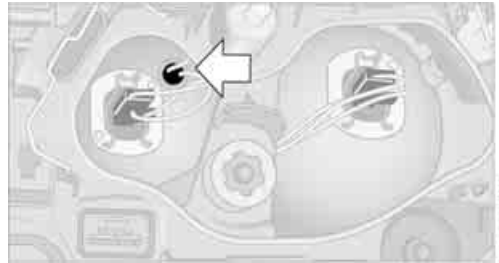

The figure shows the right-hand headlamp.

2. Pull out the bulb holder.
3. Remove and replace the bulb.
4. Reinsert the bulb holder.
5. Attach the headlamp cover.

## Xenon headlamps

### Parking lamps, roadside parking lamps, daytime running lamps

H8 bulb, 35 watts

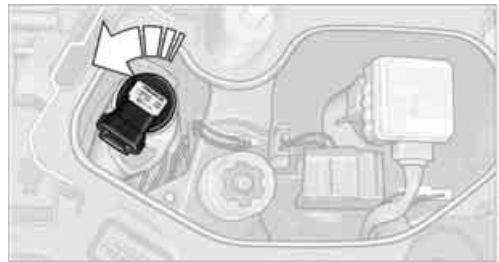

The figure shows the right-hand headlamp.

1. Remove the headlamp cover.
2. Turn the bulb, see arrow, and remove it.
3. Pull off the connector and replace the bulb.

- Attach the connector, insert the bulb and turn it all the way in the opposite direction.
- Attach the headlamp cover.

## Corner-illuminating lamps

H3 bulb, 55 watts

The figure shows the right-hand headlamp.

- Remove the top headlamp cover, using the screwdriver to push the detents to one side.

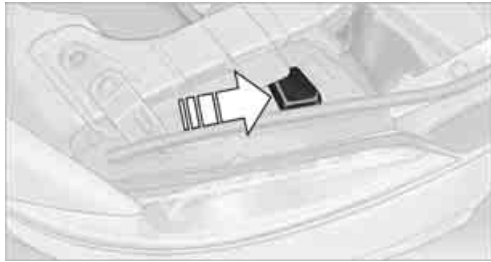

- Turn the bulb holder, see arrow, and remove it.



- Slide the bulb out of the holder and pull off the connector.
- Replace the bulb and attach the connector.
- Insert the bulb holder and turn it all the way in the opposite direction.
- Attach the headlamp cover.

## Turn signals, front

PY21W Silver Vision bulb, 21 watts

The turn signal bulb can be changed via a cover in the wheel arch.



- Turn the respective wheel inwards.
- Using a coin, turn both locks of the cover all the way to the left, arrows 1, and remove the cover.
- Turn the bulb holder to the left and remove it, arrow 2.
- Apply gentle pressure to the bulb while turning it to the right for removal and replacement.
- Insert the bulb holder and lock it by turning it to the right.
- Attach the cover by positioning the bottom edge first and then turning both locks all the way to the right.

## Tail lamps

- Turn signal:  
PY21W bulb, 21 watts
- Backup lamp:  
W16W bulb, 16 watts
- Brake lamps:  
P21W bulb, 21 watts
- Brake Force Display lamp:  
H21W bulb, 21 watts

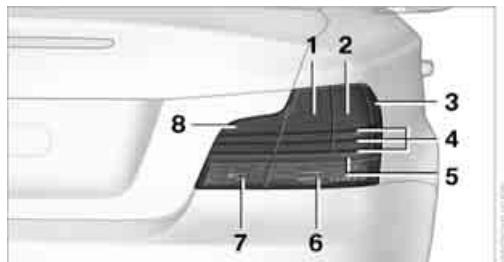

- Inner brake lamp
- Outer brake lamp



- 3 Lateral reflector
- 4 Roadside parking lamp and tail lamp LED
- 5 Reflector
- 6 Turn signal
- 7 Backup lamp
- 8 Brake Force Display lamp

## Replacing tail lamps

### Outer brake lamp



The outer brake lamp can be accessed through a single socket.

The figure shows the right side of the vehicle.

1. Remove the cover from the panel of the cargo bay.
2. Turn the bulb holder to the left, see arrow, and remove it.
3. Apply gentle pressure to the bulb while turning it to the left for removal and replacement.
4. Attach the bulb holder and turn it all the way in the opposite direction.
5. Reattach the cover.

 The roadside parking lamp/tail lamp uses LED design. After replacing the bulb, ensure that the bulb holder is properly seated, otherwise the roadside parking lamp/tail lamp may not work. ◀

### Inner brake lamp, turn signal, backup lamp and Brake Force Display lamp

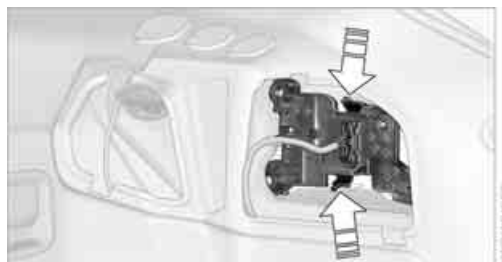

The bulbs are integrated in a single bulb holder.

1. Remove the cover from the panel of the cargo bay.
2. Detach the bulb holder by pressing together the clips, see arrows, and remove it.
3. Brake lamps and turn signal: apply gentle pressure to the bulb while turning it to the left for removal and replacement.
4. Backup lamp: pull the bulb out of the socket and replace it.
5. Attach the bulb holder and let it snap into place.
6. Reattach the cover.

### License plate lamps and center brake lamp

These lamps use LED technology for operation. In the event of a malfunction, please contact your BMW center or a workshop that works according to BMW repair procedures with correspondingly trained personnel.

## Changing wheels

Your BMW is equipped with Run-Flat Tires as standard. This removes the need to change a wheel immediately in the event of a puncture.

For information on continuing to drive with a damaged tire, refer to Indication of a flat tire on page 67.

The symbol identifying Run-Flat Tires is a circle with the letters RSC on the sidewall, refer to Run-Flat Tires, page 112.

When mounting new tires or changing over from summer to winter tires and vice versa, mount Run-Flat Tires for your own safety. In the event of a flat, no spare wheel is available. Your BMW center will be glad to advise you. Refer also to New wheels and tires, page 112.

 The tools for changing wheels are available as optional accessories from your BMW center. ◀

## Jack mounting points

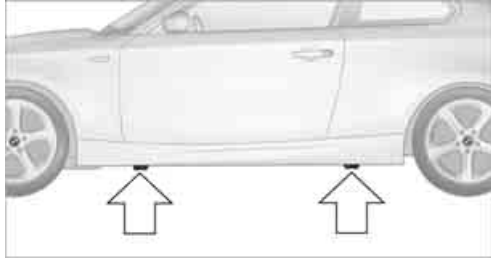

The jacking points are at the positions shown in the illustration.

## Vehicle battery

### Battery care

The battery is 100% maintenance-free, the electrolyte will last for the life of the battery when the vehicle is operated in a temperate climate. Your BMW center will be glad to advise in all matters concerning the battery.

### Charging the battery

Only charge the battery in the vehicle via the terminals in the engine compartment with the engine off. Connections, refer to Jump starting on page 131.

### Disposal

 Have old batteries disposed of by your BMW center or hand them in to a recycling center. Maintain the battery in an upright position for transport and storage. Always secure the battery against tipping over during transport. ◀

## Power failure

After a temporary power loss, the functioning of some equipment may be limited and require reinitialization. Individual settings may likewise have been lost and will have to be programmed:

- ▷ Time and date  
These values must be updated, refer to page 62.
- ▷ Radio  
Stations must be stored again, refer to the separate Owner's Manual for Radio.
- ▷ Glass roof  
It may happen that the roof can only be raised. The system must be initialized. Please contact your BMW center.
- ▷ Seat and mirror memory\*  
The positions must be stored again, refer to page 39.
- ▷ Inside rearview mirror with digital compass  
The system must be calibrated, refer to page 88.

## Fuses

 Never attempt to repair a blown fuse and do not replace a defective fuse with a substitute of another color or amperage rating, otherwise this could lead to a circuit overload, ultimately resulting in a fire in the vehicle. ◀

### In the glove compartment

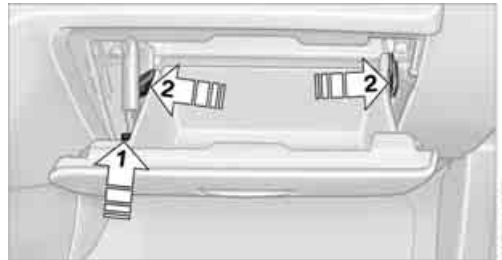

Accessing the fuse box:

1. Open the glove compartment.
2. Remove the damper, arrow 1, from the lower holder by applying forward pressure.

3. Disengage the glove compartment by pressing on both tabs, arrows **2**, and fold it down.

Spare fuses and a pair of plastic forceps are set in holders on the distributor box.

Information on fuse assignment can be found next to the distributor box.

After replacing a fuse, press the glove compartment upward until it engages and reattach the damper.

# Giving and receiving assistance

## Emergency Request\*

Conditions for an Emergency Request:

- ▷ Full preparation package mobile phone: this equipment makes it possible to send an Emergency Request even if no mobile phone is paired with the vehicle.
- ▷ Radio readiness is on.
- ▷ BMW Assist is activated. Activating BMW Assist, refer to separate Owner's Manual.
- ▷ The BMW Assist system is logged on to a mobile phone network.
- ▷ The Emergency Request system is operable.

Once your service contract for BMW Assist expires, the BMW Assist system can be deactivated by a BMW center without you having to visit a workshop. Once the BMW Assist system has been deactivated, Emergency Requests are not possible. The BMW Assist system can be reactivated by a BMW center after a new contract has been signed.

## Sending an Emergency Request

1. Briefly press the cover flap to open.

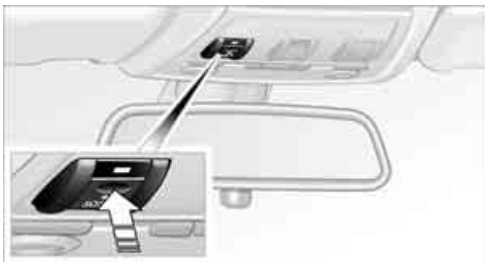

2. Press the SOS button until the LED in the button lights up.

As soon as the voice connection to the BMW Assist Response Center has been established, the LED flashes.

Once the BMW Assist Response Center has received your Emergency Request, the

BMW Assist Response Center contacts you and takes further steps to help you. Even if you are unable to respond, the BMW Assist Response Center will be able to initiate further steps to assist you under certain conditions.

If the circumstances allow this, remain in the vehicle until the connection has been established. You will then be able to provide a detailed description of the situation.

Data for determining the necessary rescue measures are transmitted to the BMW Assist Response Center, e.g. the current position of your vehicle, if it can be determined.

If the LED is flashing but the BMW Assist Response Center cannot be heard over the hands-free system, it is possible that the hands-free system is malfunctioning. You may still be heard by the BMW Assist Response Center, however.

Under certain conditions, an Emergency Request is sent automatically immediately after a severe accident. This Automatic Collision Notification is not affected by the button being pressed.



For technical reasons, the Emergency Request service cannot be guaranteed for the most unfavorable conditions. ◀

## Roadside Assistance

The BMW Roadside Assistance is there to assist you around the clock in the event of a breakdown, including on weekends and public holidays.

The phone numbers of the Roadside Assistance in your home country can be found in the Contact brochure.

## First aid pouch\*

Some of the articles contained in the first aid pouch have a limited service life. Therefore,

check the expiration dates of the contents regularly and replace any items in good time, if necessary.



The first aid pouch is located on the right-hand side of the cargo bay in a storage area.

## Warning triangle\*

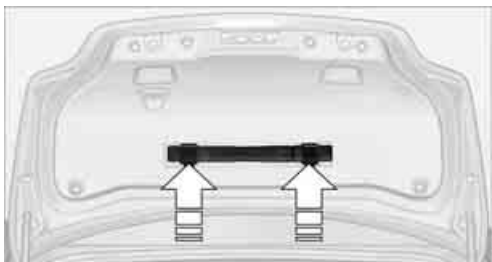

The warning triangle is located in a holder in the luggage compartment lid. Press the tabs to take it out.

## Jump starting

If the car's own battery is flat, your BMW's engine can be started by connecting two jumper cables to another vehicle's battery. You can also use the same method to help start another vehicle. Only use jumper cables with fully-insulated clamp handles.

**⚠** Do not touch any electrically live parts when the engine is running, or a fatal accident may occur. Carefully adhere to the following sequence, both to prevent damage to one or both vehicles, and to guard against possible personal injuries. ◀

## Preparation

1. Check whether the battery of the other vehicle has a voltage of 12 volts and approximately the same capacitance in Ah. This information can be found on the battery.
2. Switch off the engine of the assisting vehicle.
3. Switch off any consumers in both vehicles.

**⚠** There must not be any contact between the bodies of the two vehicles, otherwise there is a danger of shorting. ◀

## Connecting jumper cables

**⚠** Connect the jumper cables in the correct order to prevent sparking at the battery, which could cause injury. ◀

Your BMW has a jump-starting connection in the engine compartment which acts as the battery's positive terminal, refer also to the Engine compartment overview on page 115. The cap is marked with +.

1. Pull the cap of the BMW jump-starting connection up to remove.

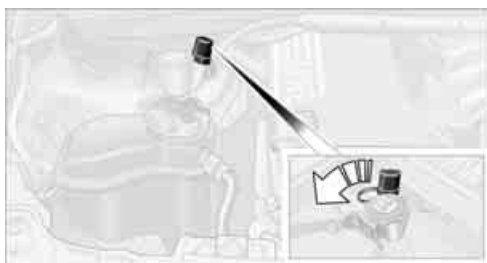

2. Attach one terminal clamp of the plus/+ jumper cable to the positive terminal of the battery or a starting-aid terminal of the vehicle providing assistance.
3. Attach the second terminal clamp of the plus/+ jumper cable to the positive terminal of the battery or a starting-aid terminal of the vehicle to be started.
4. Attach one terminal clamp of the minus/- jumper cable to the negative terminal of the battery or to an engine or body ground of the assisting vehicle.

Your BMW has a special nut as body ground or negative pole.



- Attach the second terminal clamp of the minus/- jumper cable to the negative terminal of the battery or to the engine or body ground of the vehicle to be started.

### Starting the engine

- Start the engine of the donor vehicle and allow it to run for a few minutes at slightly increased idle speed.
- Start the engine on the other vehicle in the usual way.  
If the first start attempt is not successful, wait a few minutes before another attempt in order to allow the discharged battery to recharge.
- Let the engines run for a few minutes.
- Disconnect the jumper cables by reversing the above connecting sequence.

If necessary, have the battery checked and recharged.

- Never use spray fluids to start the engine. ◀

### Tow-starting, towing away

- Observe the applicable laws and regulations for tow-starting and towing vehicles. ◀
- Do not transport any passengers other than the driver in a vehicle that is being towed. ◀

### Using a tow fitting

The screw-in tow fitting must always be carried in the car. It can be screwed in at the front or rear of the BMW.

It is stored with the onboard tool kit underneath the floor mat in the cargo bay, refer to page 124.

- Use only the tow fitting provided with the vehicle and screw it all the way in. Use the tow fitting for towing on paved roads only. Avoid lateral loading of the tow fitting, e.g. do not lift the vehicle by the tow fitting. Otherwise the tow fitting and the vehicle could be damaged. ◀

### Access to screw thread

Rectangular cover panel in bumper:

Press the arrow on the cover.

#### Front

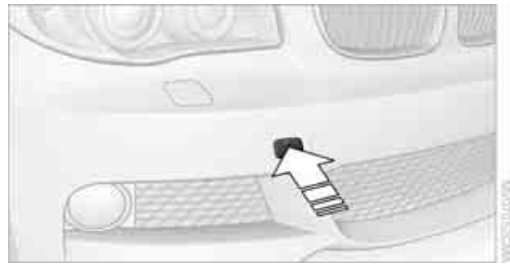

#### Rear

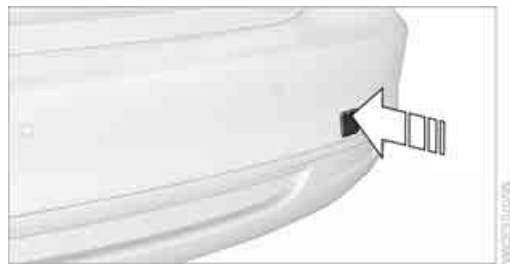

### Being towed

- Make sure that the ignition is switched on, refer to page 47, otherwise the low-beam headlamps, tail lamps, turn signal indicators and windshield wipers may be unavailable. Power steering assistance is not available when the engine is not running. Thus, braking and steering will require increased effort. Active steering

is not active and it will be necessary to turn the steering wheel further. ◀

## Manual transmission

Gearshift lever in neutral position.

## Automatic transmission

Selector lever in position N.

Changing the selector lever position, refer to page 50.

 Do not exceed a towing speed of 45 mph/ 70 km/h and a towing distance of 90 miles/150 km, otherwise the automatic transmission may be damaged. ◀

## Towing methods

 Do not lift the vehicle by a tow fitting or body and chassis parts, otherwise damage may result. ◀

### With a tow bar

 The towing vehicle must not be lighter than the towed vehicle, otherwise it may be impossible to maintain control. ◀

The tow fittings used should be on the same side on both vehicles. Should it prove impossible to avoid mounting the tow bar at an angle, please observe the following:

- ▷ Clearance and maneuvering capability will be sharply limited during cornering.
- ▷ The tow bar will generate lateral forces if it is attached offset.

 Attach the tow bar to the tow fittings only, as attaching it to other parts of the vehicle could result in damage. ◀

### With a tow rope

When starting off in the towing vehicle, make sure that the tow rope is taut.

 To avoid jerking and the associated stresses on vehicle components when towing, always use nylon ropes or nylon straps. Attach the tow rope to the tow fittings only, as attaching it to other parts of the vehicle could result in damage. ◀

## With a tow truck

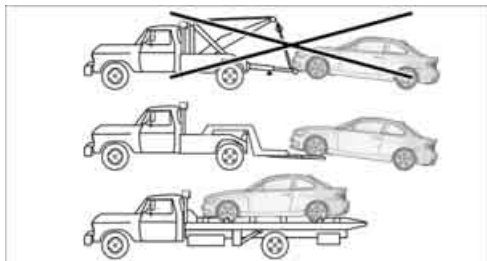

Have the BMW transported with a tow truck with a so-called lift bar or on a flat bed.

Do not tow the vehicle with just the rear axle raised as this may cause the steering to turn.

## Tow-starting

Avoid tow-starting the vehicle whenever possible; instead, jump-start the engine, refer to page 131. Vehicles with a catalytic converter should only be tow-started when the engine is cold, vehicles with an automatic transmission cannot be tow-started at all.

1. Switch on the hazard warning flashers, comply with local regulations.
2. Switch on the ignition, refer to page 47.
3. Shift into 3rd gear.
4. Have the vehicle tow-started with the clutch depressed all the way and slowly release the clutch. After the engine starts, immediately depress the clutch completely again.
5. Stop at a suitable location, remove the tow bar or rope and switch off the hazard warning flashers.
6. Have the vehicle checked.









# Indicator and warning lamps



















Indicator and warning lamps can light up in a variety of combinations and colors. See the table for information on causes and how to react. Note whether a lamp comes on alone or in combination with another. Some lamps can light up in different colors. Corresponding distinctions are made in the text.









1	2	Cause	Special actions to be taken
		Turn signals	
		High beams/headlamp flasher switched on	
		Fog lamps switched on	
		Fasten safety belts	Fasten your safety belt, refer also to page 41.
BRAKE		Indication in US models Parking brake applied	Release the parking brake.
		Indication in Canadian models Parking brake applied	Release the parking brake.
		Outside temperature warning	Drive cautiously, refer also to page 56.
		Lights up briefly: ▷ Approx. 2.1 US gallons/8 liters of fuel remain in the tank  Remains on: Remaining operating range is no more than 30 miles/50 km, refer to page 57	
		Engine refuses to start	Depress the brake or clutch in order to start the engine, refer to page 48.
		Ignition switched on and driver's door open	Switch off the ignition, refer to page 47, or close the driver's door.
		Parking lamps still on	
		Roadside parking lamps still on	Switch off the roadside parking lamps, refer to page 76.



































1	2	Cause	Special actions to be taken
		Door open	
		Engine compartment lid open	
		Luggage compartment lid open	
		Lights up in red: Convertible top not locked	Automatic lock malfunctioning. Lock the convertible top manually, refer to page 32. Have it checked by your BMW center.
		Electronic failure when closing convertible top	Close the convertible top manually, refer to page 32. Have it checked by your BMW center.
		Lights up in yellow: Cargo bay partition not in lowermost position. Convertible top cannot be moved	Fold the cargo bay partition down.
		Vehicle speed too high for convertible top movement	Reduce speed to below 30 mph/ 50 km/h and continue convertible top movement.
		Rollover protection system malfunctioning	Have the rollover protection system checked by your nearest BMW center.
		Gas cap missing or loose	Make sure that the gas cap is correctly positioned and close it until it audibly clicks. Do not jam the strap between the gas cap and the vehicle.
		Windshield washer fluid level too low	Add washer fluid as soon as possible, refer to page 53.
		Lights up in red: Service due	Arrange a service appointment. Check service requirements, refer to page 61.
		Lights up in yellow: The engine will start the next time the start/stop button is touched, possibly without the brake or clutch being depressed	

1	2	Cause	Special actions to be taken
		Remote control malfunctioning or, in cars with convenient access, not present	The engine cannot be started. Have the remote control checked, if necessary.
		Battery of remote control discharged	Use the remote control for a longer journey or, in cars with convenient access, replace the battery.
		Belt tensioners and/or airbag system failed	Have the system checked immediately.
		Active steering defective	You can continue your journey. Steering characteristics are modified and steering wheel could be off-center. Have the system checked as soon as possible.
		Steering assistance failed	Markedly different steering response. You can continue your journey, but moderate your speed and exercise due caution. Have the system checked as soon as possible.
		Lights up: Emergency Request system has failed or is malfunctioning	Have the system checked as soon as possible.
		Lights up in red: Engine malfunction	Stop the car and switch off the engine. You cannot continue your journey. Contact your BMW center.
		Lights up in yellow: Full engine power is no longer available	You can continue your journey, but moderate your speed and exercise due caution. Have the engine checked as soon as possible.
		Indication in US models: Warning lamp flashes: Engine malfunction under high load. High engine load will result in damage to the catalytic converter	You can continue your journey, but moderate your speed and exercise due caution. Have the vehicle checked without delay.
		Warning lamp comes on: Engine malfunction with adverse effect on exhaust emissions	Have the car checked as soon as possible.

1	2	Cause	Special actions to be taken
	<p>Indication in Canadian models:</p> <p>Warning lamp flashes:</p> <p>Engine malfunction under high load. High engine load will result in damage to the catalytic converter</p> <p>Warning lamp comes on:</p> <p>Engine malfunction with adverse effect on exhaust emissions</p>	<p>You can continue your journey, but moderate your speed and exercise due caution. Have the vehicle checked without delay.</p> <p>Have the car checked as soon as possible.</p>	
	<p>Lights up in red:</p> <p>Engine overheating</p> <p>Lights up in yellow:</p> <p>Engine too hot</p>	<p>Carefully bring the car to a stop, switch off the engine and allow it to cool down. Do not open the hood, otherwise there would be a risk of injury by scalding. Contact your BMW center.</p> <p>Continue driving at more moderate speed so that the engine can cool down. Have the engine checked without delay if the situation reoccurs.</p>	
	<p>Lights up in red:</p> <p>Battery is no longer being charged. Alternator malfunction</p> <p>Lights up in yellow:</p> <p>Battery charge level very low, battery aged or not securely connected</p>	<p>Switch off all unnecessary electrical consumers. Have the vehicle's power supply system checked immediately.</p> <p>Have the battery checked as soon as possible.</p>	
	<p>Engine oil pressure too low</p>	<p>Stop immediately and switch off the engine. You cannot continue your journey. Contact your BMW center.</p>	
	<p>Engine oil level too low</p>	<p>Add engine oil immediately; refer to page 115 for more information.</p>	
BRAKE	<p>Indication in US models:</p> <p>Parking brake applied</p>		
	<p>Indication in Canadian models:</p> <p>Parking brake applied</p>		

1	2	Cause	Special actions to be taken
BRAKE		Indication in US models	
		Lights up in red: Brake fluid level too low	Reduced braking effect, stop the car carefully. Contact your BMW center.
		Lights up in yellow: Drive-off assistant has failed. The car will not be held in place after the brake is released	Have the system checked as soon as possible.
		Indication in Canadian models	
		Lights up in red: Brake fluid level too low	Reduced braking effect, stop the car carefully. Contact your BMW center.
		Lights up in yellow: Drive-off assistant has failed. The car will not be held in place after the brake is released	Have the system checked as soon as possible.
BRAKE		Indication in US models: Brake pads worn	Have the condition of the brake pads checked without delay.
		Indication in Canadian models: Brake pads worn	Have the condition of the brake pads checked without delay.
		Lights up in red: <ul style="list-style-type: none"> <li>▷ Starter failed or</li> <li>▷ ignition malfunctioning. Engine restart only possible when brake is depressed or</li> <li>▷ lighting system failed. Low beams/ tail lamps and brake lamps still operational. All other lamps failed</li> </ul>	Have the system in question checked without delay. The engine cannot be restarted. Depress the brake to restart the engine.
		Lights up in yellow: <ul style="list-style-type: none"> <li>▷ Control of the brake lamps failed or</li> <li>▷ fuel supply malfunctioning, or</li> <li>▷ electrical system of trailer hitch* failed</li> </ul>	You can continue your journey, but moderate your speed and exercise due caution. Have the system in question checked without delay.
		Flashing: Dynamic Stability Control DSC or Dynamic Traction Control DTC is controlling drive and braking forces, refer also to page 65	

1	2	Cause	Special actions to be taken
DTC		Dynamic Traction Control DTC activated, refer also to page 65	
		Dynamic Stability Control DSC and Dynamic Traction Control DTC deactivated, refer also to page 65	Driving stability limited during acceleration and cornering. You can continue your journey, but moderate your speed and exercise due caution.
		Suspension control system failed, refer also to page 64	Driving stability limited during acceleration and cornering. You can continue your journey, but moderate your speed and exercise due caution. Have the system checked as soon as possible.
ABS BRAKE		Indication in US models: The driving stability control systems, including ABS and the Tire Pressure Monitor, have failed, refer also to page 64	Driving stability limited during acceleration and cornering. You can continue your journey, but moderate your speed and exercise due caution. Have the system checked as soon as possible.
 		Indication* in Canadian models: The driving stability control systems, including ABS and the Flat Tire Monitor or Tire Pressure Monitor*, have failed, refer also to page 64	Driving stability limited during acceleration and cornering. You can continue your journey, but moderate your speed and exercise due caution. Have the system checked as soon as possible.
ABS   		Indication* in Canadian models: The driving stability control systems, including ABS and the Flat Tire Monitor or Tire Pressure Monitor*, have failed, refer also to page 64	Driving stability limited during acceleration and cornering. You can continue your journey, but moderate your speed and exercise due caution. Have the system checked as soon as possible.
ABS BRAKE 		Indication in US models: Vehicle electronics failed	You cannot continue your journey. Contact your BMW center.
  		Indication* in Canadian models: Vehicle electronics failed	You cannot continue your journey. Contact your BMW center.

1	2	Cause	Special actions to be taken
ABS   		Indication* in Canadian models: Vehicle electronics failed	You cannot continue your journey. Contact your BMW center.
 		Vehicles with Flat Tire Monitor*:  Light up in yellow and red: <ul style="list-style-type: none"> <li>▶ Tire is deflated</li> <li>▶ Flat Tire Monitor not initialized</li> </ul> Light up in yellow: Flat Tire Monitor failed. Punctures are not indicated	Carefully bring the car to a stop. Comply with the additional information starting on page 66.  Initialize Flat Tire Monitor, refer to page 66.  Have the system checked.
 		Vehicles with Tire Pressure Monitor*:  Light up in yellow and red: <ul style="list-style-type: none"> <li>▶ There is a flat tire or substantial loss of tire pressure</li> </ul>	Carefully bring the car to a stop. Comply with the additional information starting on page 68.
 		Vehicles with Tire Pressure Monitor*:  Light up in yellow: <ul style="list-style-type: none"> <li>▶ Tire Pressure Monitor not initialized</li> </ul> The small lamp flashes in yellow and then lights up continuously; the larger lamp comes on in yellow: <ul style="list-style-type: none"> <li>▶ Tire Pressure Monitor has failed. Punctures are not indicated</li> </ul>	Check the inflation pressure and reset the system, refer to page 68.  Have the system checked. Comply with the additional information starting on page 69.



Lights up in red:

- ▷ Transmission limp-home program active with restricted range of gears, possibly with reduced acceleration.

Gears can be engaged without depressing the brake

Lights up in yellow:

- ▷ Automatic selector lever locked: Selector lever locked in position P with engine running and brake depressed or
- ▷ Brake signal malfunctioning: gear can be engaged without depressing the brake

You can continue your journey, but moderate your speed and exercise due caution. Have the system checked without delay.

Always depress the brake to engage a gear.

Have the system checked as soon as possible.

Override the selector lever lock, refer to page 51.

Always depress the brake to engage a gear. Before leaving the vehicle, move the selector lever to position P and switch off the engine.



Lights up in red:

Transmission overheating

Lights up in yellow:

Transmission too hot

Bring the car to a stop and move the selector lever to position P. Allow the transmission to cool down. You can continue your journey, but moderate your speed and exercise due caution. Have the system checked if the situation reoccurs.

Avoid high engine loads. You can continue your journey, but moderate your speed and exercise due caution.



Selector lever position P not engaged.  
Vehicle not prevented from rolling



Selector lever position P not engaged.  
Ignition cannot be switched off

Engage selector lever position P when you wish to switch off the ignition, refer to page 47.



Pinch protection system of the power windows malfunctioning

Have the system checked.













Pinch protection system of the electric glass roof malfunctioning

Have the system checked.



Cruise control system failed

You can continue your journey. Have the system checked.

1	2	Cause	Special actions to be taken
		Park Distance Control failed	Have the system checked.
		Bulb of exterior lighting system failed	Have the exterior lighting checked as soon as possible.
		Low-beam headlamp or fog lamp failed	Have the low beams checked as soon as possible.
		High-beam headlamp failed	Have the high-beam headlamps checked.
		Headlamp beam throw adjustment system failed	Have the headlamp beam throw adjustment system checked.
		Adaptive Head Light failed	
		Coolant level too low	Add coolant immediately, refer to page 117.
		Lights up in red: Service appointment overdue	Arrange a service appointment. Check service requirements, refer to page 61.
		Lights up in yellow: Service due	Arrange a service appointment. Check service requirements, refer to page 61.
		No service due	
		Set speed limit* has been exceeded	
		Time and date no longer correct	Set the time and date, refer to page 62.







## Reference

This chapter contains technical data and an index that will help you find information most quickly.

# Technical data

## Engine data

		128i	135i
Displacement	cu in/cm <sup>3</sup>	182.8/2,996	181.8/2,979
Number of cylinders		6	6
Maximum power output	hp	230	300
at engine speed	rpm	6,500	5,800
Maximum torque	lb ft/Nm	200/270	300/407
at engine speed	rpm	2,750	1,400 - 5,000

## Dimensions

### Coupe

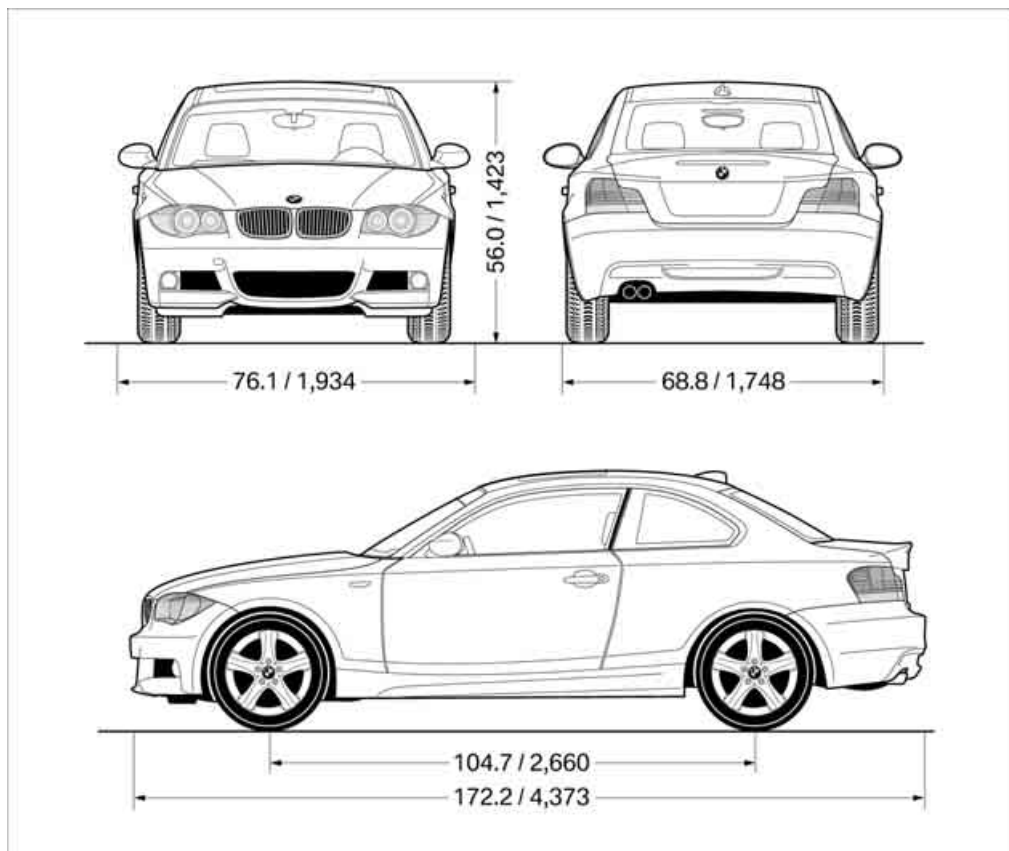

All dimensions given in inches/mm.  
Smallest turning circle dia.: 35 ft 1 in/10.7 m.

Convertible

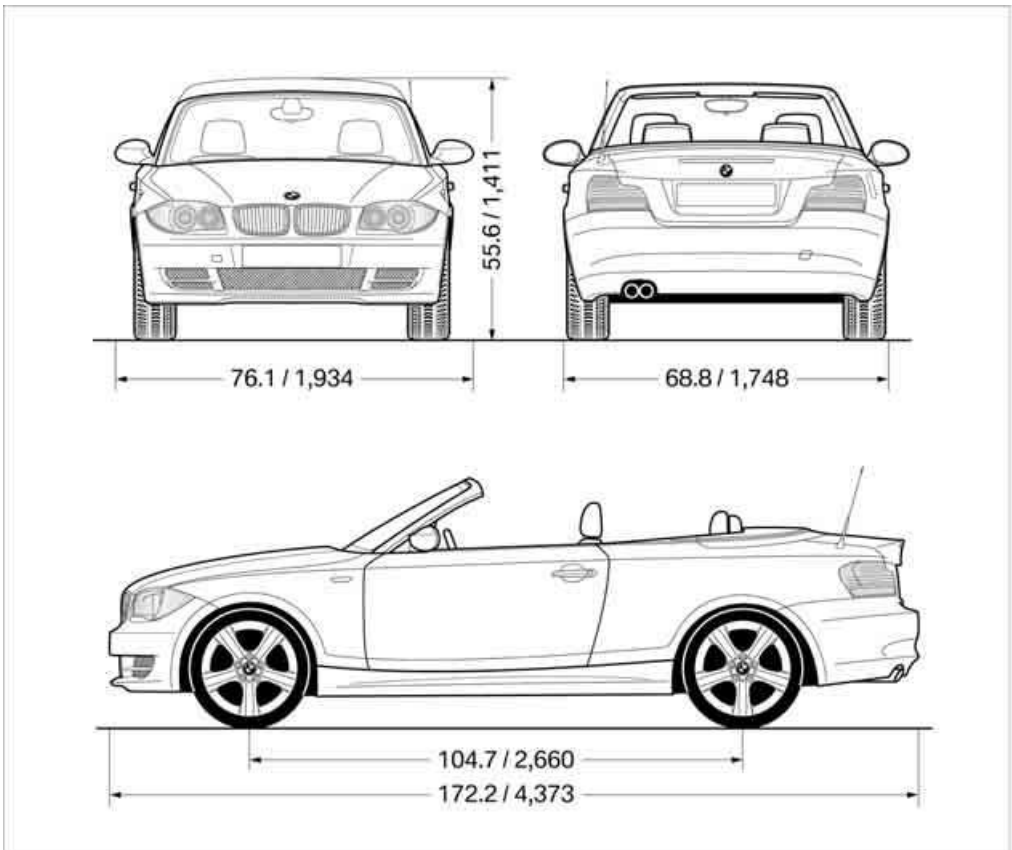

WV000256101

All dimensions given in inches/mm.  
 Smallest turning circle dia.: 35 ft 1 in/10.7 m.

# Weights

## Coupe

		128i	135i
Approved gross weight			
▷ with manual transmission	lbs/kg	4,134/1,875	4,255/1,930
▷ with automatic transmission	lbs/kg	4,211/1,910	4,266/1,935
Load	lbs/kg	794/360	794/360
Approved front axle load	lbs/kg	2,028/920	2,116/960
Approved rear axle load			
▷ with manual transmission	lbs/kg	2,249/1,020	2,249/1,020
▷ with automatic transmission	lbs/kg	2,393/1,040	2,393/1,040
Approved roof load capacity	lbs/kg	165/75	165/75
Cargo bay capacity	cu ft/liters	13.1/370	13.1/370

## Convertible

		128i	135i
Approved gross weight			
▷ with manual transmission	lbs/kg	4,398/1,995	4,564/2,070
▷ with automatic transmission	lbs/kg	4,475/2,030	4,575/2,075
Load	lbs/kg	772/350	772/350
Approved front axle load	lbs/kg	2,050/930	2,149/975
Approved rear axle load	lbs/kg	2,467/1,119	2,469/1,120
Approved roof load capacity	lbs/kg	-	-
Cargo bay capacity	cu ft/liters	9.1 - 10.7/260 - 305	9.1 - 10.7/260 - 305

## Capacities

			Notes
Fuel tank:	US gal/liters	approx. 14.0/53	Fuel grade: page <a href="#">105</a>
including reserve of	US gal/liters	approx. 2.1/8.0	
Window washer system			For more details: page <a href="#">53</a>
including headlamp washers	US qt/liters	approx. 6.3/6.0	





# Everything from A to Z

## Index

### A

- ABS Antilock Brake System **64**
- Accessories, refer to The individual vehicle **5**
- Accident, reporting, refer to Emergency Request **130**
- Activated-charcoal filter **84**
- Active steering **70**
- Adaptive Head Light **76**
- Additives
  - coolant **117**
  - engine oil **116**
- Airbags **71**
  - sitting safely **35**
  - warning lamp **72**
- Air conditioner **79**
- Air distribution
  - automatic **83**
  - individual **80**
- Air flow rate **80, 83**
- Airing, refer to Ventilation **81, 84**
- Air outlets, refer to Air vents **79**
- Air pressure, checking, refer to Tire inflation pressure **106**
- Air recirculation, refer to Recirculated-air mode **80, 83**
- Air vents **79**
- AKI, refer to Fuel specifications **104**
- Alarm system **24**
  - avoiding unintentional alarms **25**
  - interior motion sensor **25**
  - switching off an alarm **25**
  - tilt alarm sensor **25**
- All-season tires, refer to Winter tires **113**
- Ambient air, refer to Recirculated-air mode **80, 83**
- Antifreeze
  - coolant **117**
  - washer fluid **53**
- Antilock Brake System ABS **64**
- Anti-theft alarm system, refer to Alarm system **24**
- Anti-theft system **19**
- Approved axle loads, refer to Weights **149**
- Approved gross vehicle weight, refer to Weights **149**
- Armrest, refer to Center armrest **88**
- Ashtray **90**
- Assistance systems, refer to Dynamic Stability Control DSC **65**
- AUC Automatic recirculated-air control **83**
- Automatic
  - air distribution **83**
  - air flow rate **83**
  - cruise control **54**
  - headlamp control **74**
- Automatic car wash, refer to Car wash **98**
- Automatic car washes **120**
- Automatic climate control **79**
- Automatic air distribution **83**
- Automatic curb monitor **42**
- Automatic lamps
  - refer to Welcome lamps **74**
- Automatic recirculated-air control AUC **83**

- Automatic transmission with Steptronic **49**
  - interlock **50**
  - selector lever lock **50**
  - shiftlock **50**
  - towing **132**
  - tow-starting **132**
- AUTO program for automatic climate control **83**
- Average fuel consumption **58**
  - setting the units **60**
- Average speed **58**
- Avoiding unintentional alarms **25**
- Axle loads, refer to Weights **149**

### B

- Backrests, refer to Seats **36**
- Backrest width adjustment **37**
- Back seats, refer to Rear seats
  - adjusting head restraints **38**
- Backup lamp, replacing bulb **127**
- Bag for skis, refer to Ski bag **92**
- Band-aids, refer to First-aid pouch **130**
- Bar, refer to Tow-starting, towing away **133**
- Battery **128**
  - charging **128**
  - disposal **27, 128**
  - jump starting **131**
  - temporary power failure **128**
- Battery renewal
  - remote control for vehicle **27**
- Being towed **132**
- Belts, refer to Safety belts **41**
- Belt tensioner, refer to Safety belts **41**

Beverage holders, refer to  
Cup holders **89**  
Blower, refer to Air flow  
rate **80, 83**  
BMW  
– car shampoo **123**  
BMW Maintenance  
System **118**  
Bottle holders, refer to Cup  
holders **89**  
Brake assist, refer to Dynamic  
Brake Control **65**  
Brake fluid  
– service requirements **61**  
Brake Force Display **70**  
Brake lamps  
– Brake Force Display **70**  
– replacing bulb **127**  
Brake pads, breaking in **96**  
Brake rotors **98**  
– brakes **96**  
– breaking in **96**  
Brakes  
– ABS **65**  
– BMW Maintenance  
System **118**  
– braking safely **98**  
– breaking in **96**  
– parking brake **49**  
– service requirements **61**  
Brake system **96**  
– BMW Maintenance  
System **118**  
– breaking in **96**  
– disc brakes **98**  
Breakdown services, refer to  
Roadside Assistance **130**  
Breaking in the clutch **96**  
Break-in period **96**  
Bulb changing, refer to Lamps  
and bulbs **124**  
Bulbs, changing **124**  
Button for starting the  
engine **47**  
Buttons on the steering  
wheel **11**

## C

California Proposition 65  
warning **6**  
Can holders, refer to Cup  
holders **89**  
Capacities **150**  
Capacity of the cargo bay **149**  
Car battery, refer to Vehicle  
battery **128**  
Car care, refer to Care **120**  
Care **120**  
– automatic car washes **120**  
– care products **120**  
– carpets **122**  
– CD/DVD drives **123**  
– chrome parts **122**  
– convertible top **121**  
– displays **123**  
– exterior **120**  
– fine wood parts **123**  
– headlamps **121**  
– high-pressure washer **120**  
– interior **122**  
– leather **122**  
– light-alloy wheels **122**  
– paintwork **121**  
– plastic parts **123**  
– rubber seals **122**  
– safety belts **123**  
– sensors and cameras **123**  
– upholstery and cloth  
trim **122**  
– washing the car  
manually **121**  
– windows **121**  
– wiper blades **121**  
Cargo, securing **100**  
Cargo bay  
– capacity **149**  
– convenient access **27**  
– enlarging, refer to Through-  
loading system **91**  
– lamp, refer to Interior  
lamps **77**  
– lid, refer to Luggage  
compartment lid **23**  
– opening from outside **23**

Cargo bay lid, refer to  
Luggage compartment  
lid **23**  
Cargo bay net, refer to  
Securing cargo **100**  
Cargo loading **99**  
– securing cargo **100**  
– stowing cargo **99**  
– vehicle **99**  
Car jack  
– jacking points **128**  
Car key, refer to Integrated  
key/remote control **18**  
Car phone  
– installation location, refer to  
Center armrest **88**  
– refer to separate Owner's  
Manual  
Car shampoo **123**  
Car wash **98**  
Catalytic converter, refer to  
Hot exhaust system **97**  
Center armrest **88**  
Center brake lamp, replacing  
bulb **127**  
Center console, refer to  
Around the center  
console **14**  
Central key, refer to Integrated  
key/remote control **18**  
Central locking  
– from inside **22**  
– from outside **19**  
Central locking system **19**  
– convenient access **26**  
Changes, technical, refer to  
For your own safety **5**  
Changing wheels **127**  
Chassis number, refer to  
Engine compartment **115**  
Check Control **62**  
Checking oil level **115**  
Child-restraint fixing system  
LATCH **45**  
Child-restraint systems **44**  
Child seats **44**  
Chrome parts **123**  
Chrome polish **123**  
Cigarette lighter **90**

- Cleaning headlamps **53**
    - washer fluid **53**
  - Cleaning your BMW, refer to Care **120**
  - Clock **56**
    - 12h/24h format **60**
    - setting time **62**
  - Closing
    - from inside **22**
    - from outside **19**
  - Clothes hooks **89**
  - Cold start, refer to Starting the engine **48**
  - Combination instrument, refer to Instrument cluster **12**
  - Comfort access, refer to Convenient access **26**
  - Comfort area, refer to Around the center console **14**
  - Compartment for remote control, refer to Ignition lock **47**
  - Compass **87**
  - Computer **57**
  - Condensation, refer to When the vehicle is parked **98**
  - Condition Based Service CBS **118**
  - Configuring settings, refer to Personal Profile **18**
  - Confirmation signals for locking/unlocking the vehicle **21**
  - Connecting vacuum cleaner, refer to Connecting electrical appliances **90**
  - Consumption, refer to Average fuel consumption **58**
  - Controls and displays **10**
  - Convenient access **26**
    - replacing the battery **27**
  - Convenient operation
    - windows **20**
    - windows with convenient access **26**
    - with convenient access **26**
  - Convenient starting, refer to Starting the engine **48**
  - Convertible
    - rollover protection system **72**
    - top **30**
    - wind deflector **33**
  - Convertible top
    - convenient opening **20**
  - Convertible top care **121**
  - Coolant **117**
    - checking level **117**
    - filling **117**
  - Coolant temperature **57**
  - Cooling, maximum **82**
  - Cooling fluid, refer to Coolant **117**
  - Copyright **2**
  - Corner-illuminating lamps **76**
  - Corner-illuminating lamps, refer to Adaptive Head Light **76**
  - Cornering lamps, refer to Adaptive Head Light **76**
  - Courtesy lamps **77**
  - Cruise control **54**
  - Cruising range **58**
  - Cup holders **89**
  - Curb weight, refer to Weights **149**
  - Current fuel consumption **58**
- ## D
- Dashboard, refer to Cockpit **10**
  - Dashboard lighting, refer to Instrument lighting **77**
  - Data
    - dimensions **147**
    - sizes **147**
  - Data, technical **146**
    - capacities **150**
    - engine **146**
    - weights **149**
  - Date
    - setting **62**
    - setting format **60**
  - Daytime running lamps, switch positions **75**
  - DBC Dynamic Brake Control **65**
  - Deactivating front passenger airbags **71**
  - Deadlocking, refer to Locking **20**
  - Decommissioning the vehicle, refer to Caring for your vehicle
  - Defect
    - door lock **22**
    - fuel filler door **104**
    - glass roof **30**
  - Defogging windows **81, 84**
  - Defrosting the windows **81, 84**
  - Defrosting windshield, refer to Defrosting windows **81, 84**
  - Defrost position, refer to Defrosting windows **81, 84**
  - Differential, breaking in **96**
  - Digital clock **56**
  - Digital compass **87**
  - Dimensions **147**
  - Directional indicators, refer to Turn signals **51**
  - Displacement, refer to Engine data **146**
  - Display lighting, refer to Instrument lighting **77**
  - Displays, refer to Instrument cluster **12**
  - Displays and controls **10**
  - Disposal
    - of coolant **117**
    - remote control battery **27**
    - vehicle battery **128**
  - Distance remaining to service, refer to Service requirements **61**
  - Distance warning, refer to Park Distance Control PDC **64**
  - Door key, refer to Integrated key/remot control **18**
  - Door lock **22**
  - Door lock, confirmation signals **21**

Doors, emergency operation **22**  
DOT Quality Grades **110**  
Draft-free ventilation **81, 84**  
Drinks holders, refer to Cup holders **89**  
Drive-off assistance, refer to DSC **65**  
Drive-off assistant **66**  
Driving lamps, refer to Parking lamps/low beams **74**  
Driving notes **96**  
Driving off on hills, refer to Drive-off assistant **66**  
Driving stability control systems **64**  
Driving through water **98**  
Driving tips, refer to Driving notes **96**  
Dry air, refer to Cooling function **84**  
DSC Dynamic Stability Control **65**  
DTC Dynamic Traction Control **65**  
– indicator lamps **65**  
Dynamic Brake Control DBC **65**  
Dynamic Stability Control DSC **65**  
Dynamic Traction Control DTC  
– indicator lamps **66**

## E

EBV Electronic brake-force distribution **65**  
Electrical malfunction  
– door lock **22**  
– fuel filler door **104**  
– glass roof **30**  
Electronic brake-force distribution EBV **65**  
Electronic oil level check **115**  
Electronic Stability Program ESP, refer to Dynamic Stability Control DSC **65**

Emergency operation, refer to Manual operation  
– door lock **22**  
– fuel filler door **104**  
– glass roof **30**  
– transmission lock, automatic transmission **51**  
Emergency release, luggage compartment lid **24**  
Emergency Request **130**  
Emergency services, refer to Roadside Assistance **130**  
Energy, saving  
– saving fuel **96**  
Engine  
– breaking in **96**  
– data **146**  
– speed **146**  
– starting **48**  
– starting, convenient access **26**  
– switching off **48**  
Engine compartment **115**  
Engine coolant, refer to Coolant **117**  
Engine oil  
– adding **116**  
– additives **116**  
– BMW Maintenance System **118**  
– checking level **115**  
– intervals between changes, refer to Service requirements **61**  
– specified engine oils **116**  
Engine output, refer to Engine data **146**  
Engine speed, refer to Engine data **146**  
Engine starting, refer to Starting the engine **48**  
ESP Electronic Stability Program, refer to Dynamic Stability Control DSC **65**  
Event data recorders **119**  
Exhaust system, refer to Hot exhaust system **97**

Exterior mirrors **41**  
– adjusting **41**  
– automatic dimming feature **43**  
– automatic heating **42**  
– folding in and out **42**  
Eyes  
– for tow-starting and towing away **132**  
– for tying down loads **100**

## F

Failure messages, refer to Check Control **62**  
Failure of an electrical consumer **128**  
False alarm, refer to Avoiding unintentional alarms **25**  
Fastening safety belts, refer to Safety belts **41**  
Filter of automatic climate control, refer to Microfilter/activated charcoal filter **84**  
Filter of heating or air conditioner, refer to Microfilter **81**  
First aid pouch **130**  
Fixture for remote control, refer to Ignition lock **47**  
Flash when locking/unlocking **21**  
Flat tire  
– Run-Flat Tires **112**  
– Tire Pressure Monitor TPM **68**  
Flat Tire Monitor FTM **66**  
– indicating a flat tire **67**  
– initializing the system **66**  
– malfunction **67**  
– system limits **66**  
Flat tires, refer to Tire condition **111**  
Fog lamps **77**  
– indicator lamp **77, 134**  
Footbrake, refer to Braking safely **98**  
Footwell lamps **77**  
For your own safety **5**

Front airbags [71](#)  
 Front seat setting [35](#)  
 Frost, removing from windows, refer to Defrosting windows [81](#), [84](#)  
 FTM, refer to Flat Tire Monitor [66](#)  
 Fuel [104](#)  
 – gauge [57](#)  
 – high-quality brands [104](#)  
 – quality [104](#)  
 – specifications [104](#)  
 – tank contents, refer to Capacities [150](#)  
 Fuel clock, refer to Fuel gauge [57](#)  
 Fuel consumption display, refer to Average fuel consumption [58](#)  
 Fuel consumption statistics, refer to Average fuel consumption [58](#)  
 Fuel display, refer to Fuel gauge [57](#)  
 Fuel filler door [104](#)  
 – releasing in the event of electrical malfunction [104](#)  
 Fuses [128](#)

## G

Garage door opener, refer to Integrated universal remote control [85](#)  
 Gasoline, refer to Required fuel [104](#)  
 Gasoline display, refer to Fuel gauge [57](#)  
 Gear change  
 – with automatic transmission [50](#)  
 – with manual transmission [49](#)  
 Gear display, with automatic transmission [49](#)  
 Gearshift lever  
 – automatic transmission with Steptronic [50](#)  
 – manual transmission [49](#)  
 General driving notes [97](#)

Glass roof, electric [29](#)  
 – closing after electrical malfunction [30](#)  
 – convenient operation [22](#)  
 – opening, closing [29](#)  
 – operation with convenient access [26](#)  
 – pinch protection system [29](#)  
 – raising [29](#)  
 – remote control [20](#)  
 Glove compartment [88](#)  
 Grills, refer to Air vents [79](#)  
 Gross vehicle weight, refer to Weights [149](#)

## H

Halogen lamps  
 – replacing bulbs [125](#)  
 Handbrake, refer to Parking brake [49](#)  
 Hands-free system [14](#)  
 Hazard warning flashers [14](#)  
 Head airbags [71](#)  
 Headlamp control, automatic [74](#)  
 Headlamp cover [125](#)  
 Headlamp flasher [51](#)  
 Headlamps  
 – replacing bulbs [125](#)  
 Head restraints [37](#)  
 Heated  
 – seats [39](#)  
 Heated mirrors [42](#)  
 Heating [79](#)  
 – mirrors [42](#)  
 – seats [39](#)  
 – steering wheel [43](#)  
 Heating, rear window [81](#), [84](#)  
 Heating and ventilation [79](#)  
 Heating during a stop [83](#)  
 Heavy loads, refer to Stowing cargo [99](#)  
 Height, refer to Dimensions [147](#)  
 Height adjustment  
 – steering wheel [43](#)

High beams [76](#)  
 – indicator lamp [134](#)  
 – replacing bulbs [125](#)  
 High-pressure washer [120](#), [121](#)  
 High water, refer to Driving through water [98](#)  
 Hills [98](#)  
 Holders for cups [89](#)  
 Hood [114](#)  
 Hot exhaust system [97](#)  
 Hydraulic brake assist, refer to Dynamic Brake Control [65](#)  
 Hydroplaning [97](#)

## I

Ice warning, refer to Outside temperature warning [56](#)  
 Identification marks  
 – tire coding [110](#)  
 Ignition [47](#)  
 – switched off [47](#)  
 – switched on [47](#)  
 Ignition key, refer to Integrated key/remote control [18](#)  
 Ignition key position 1, refer to Radio readiness [47](#)  
 Ignition key position 2, refer to Ignition on [47](#)  
 Ignition lock [47](#)  
 Imprint [2](#)  
 Indicator and warning lamps [13](#), [134](#)  
 – Tire Pressure Monitor TPM [69](#)  
 Indicator lighting, refer to Instrument lighting [77](#)  
 Individual air distribution [80](#)  
 Individual settings, refer to Personal Profile [18](#)  
 Inflation pressure, tires [106](#)  
 Inflation pressure monitoring, refer to Tire Pressure Monitor TPM [68](#)

Initializing  
– compass, refer to  
  Calibrating 88  
Initializing, Flat Tire Monitor  
  FTM 66  
Instrument cluster 12  
Instrument lighting 77  
Integrated key 18  
Integrated universal remote  
  control 85  
Interior lamps 77  
– remote control 20  
Interior motion sensor 25  
Interior rearview mirror 42  
– automatic dimming  
  feature 43  
– compass 87  
Interlock 50  
Intermittent mode of the  
  wipers 52

## J

Jacking points 128  
Jumpering, refer to Jump  
  starting 131  
Jump starting 131

## K

Key, refer to Integrated key/  
  remote control 18  
Keyless go, refer to  
  Convenient access 26  
Keyless opening and closing,  
  refer to Convenient  
  access 26  
Key Memory, refer to Personal  
  Profile 18  
Kick-down 50  
Knock control 104

## L

Lamps  
– Adaptive Head Light 76  
– instrument lighting 77  
– interior lighting 77

Lamps, refer to Parking lamps/  
  low beams 74  
Lamps and bulbs, replacing  
  bulbs 124  
Lashing eyes, refer to  
  Securing cargo 100  
LATCH child-restraint fixing  
  system 45  
Leather care 122  
LED Light-emitting  
  diodes 124  
Length, refer to  
  Dimensions 147  
License plate lamp, replacing  
  bulb 127  
Light-alloy wheels 122  
Light-emitting diodes  
  LED 124  
Lighter 90  
– socket 90  
Lighting  
– lamps and bulbs 124  
– of instruments 77  
– of vehicle, refer to Lamps 74  
Light switch 74  
Limit, refer to Speed limit  
  – indicator lamp 142  
Load 99  
Load securing equipment,  
  refer to Securing cargo 100  
Lock buttons of doors, refer to  
  Locking 23  
Locking  
– adjusting confirmation  
  signal 21  
– from inside 23  
– from outside 20  
– without remote control, refer  
  to Convenient access 26  
Locking and unlocking doors  
– from inside 22  
– from outside 19  
Low-beam headlamps 74  
– automatic 74  
– replacing bulbs 125  
Lower back support, refer to  
  Lumbar support 37  
Luggage compartment, refer  
  to Cargo bay

Luggage compartment lid 23  
– convenient access 27  
– emergency release 24  
– opening from outside 23  
– unlocking with remote  
  control 20  
Luggage rack, refer to Roof-  
  mounted luggage rack 100  
Lumbar support 37

## M

M+S tires, refer to Winter  
  tires 113  
Maintenance, refer to  
– BMW Maintenance  
  System 118  
– Service booklet  
Maintenance system 118  
Malfunction warnings, refer to  
  Check Control 62  
Manual car wash 121  
Manual operation  
– door lock 22  
– fuel filler door 104  
– glass roof 30  
– transmission lock, automatic  
  transmission 51  
Manual operation with  
  automatic transmission 50  
Manual transmission 49  
Maximum cooling 82  
Maximum speed  
– for winter tires 113  
Microfilter/activated-charcoal  
  filter for automatic climate  
  control 84  
Microfilter for heating or air  
  conditioner 81  
Microphone for telephone 14  
Mirror dimming feature 43  
Mirrors 41  
– automatic curb monitor 42  
– exterior mirrors 41  
– heating 42  
– interior rearview mirror 42  
Mobile phone, installation  
  location, refer to Center  
  armrest 88

Mobile phone, refer to the separate Owner's Manual  
 Modifications, technical, refer to For your own safety 5  
 Monitoring system for tire pressures, refer to Flat Tire Monitor 66  
 Multifunctional steering wheel, refer to Buttons on the steering wheel 11  
 Multifunction switch  
 – refer to Turn signals/headlamp flasher 51  
 – refer to Wiper system 52

## N

Neck support, refer to Head restraints 37  
 Nets, refer to Storage compartments 89  
 New tires 112  
 Number of cylinders, refer to Engine data 146

## O

OBD socket, refer to Socket for On-Board Diagnosis 119  
 Octane ratings, refer to Fuel specifications 104  
 Odometer 56  
 Oil, refer to Engine oil 115  
 Oil consumption 115  
 Oil level 115  
 Old batteries, refer to Disposal 128  
 Onboard tool kit 124  
 Opening and closing  
 – convenient access 26  
 – from inside 22  
 – from outside 19  
 – using the door lock 22  
 – via the remote control 19  
 Outlets, refer to Ventilation 81, 84  
 Output, refer to Engine data 146

Outside temperature display 56  
 – changing unit of measure 60  
 – on computer 60  
 Outside temperature warning 56  
 Overriding selector lever lock 51

## P

Paintwork care 121  
 Park assistant, refer to Park Distance Control 64  
 Park Distance Control PDC 64  
 Parking  
 – vehicle 48  
 Parking aid, refer to Park Distance Control PDC 64  
 Parking brake 49  
 – indicator lamp 49  
 – manual activation 49  
 Parking lamps/low beams 74  
 – replacing bulbs 125  
 Parts and accessories, refer to The individual vehicle 5  
 Passenger-side mirror tilt function 42  
 Pathway lighting 74  
 Personal Profile 18  
 Pinch protection system  
 – glass roof, electric 29  
 – windows 28  
 Placing a call, refer to telephone owner's manual  
 Polish 123  
 Pollen, refer to Microfilter 81  
 Pollen, refer to Microfilter/activated-charcoal filter 84  
 Power windows 27  
 Power windows, refer to Windows 27  
 Pressure, tires 106  
 Pressure monitoring of tires, refer to Flat Tire Monitor 66  
 Pressure monitoring of tires, refer to Tire Pressure Monitor TPM 68

Programmable buttons on the steering wheel 11  
 Protection function, refer to Pinch protection system  
 – glass roof, electric 29  
 – windows 28  
 Providing medical assistance, refer to First aid pouch 130  
 Puncture  
 – Flat Tire Monitor 66

## R

Radio position, refer to Radio readiness 47  
 Radio readiness 47  
 – switched off 47  
 – switched on 47  
 Rain sensor 53  
 Reading lamps 78  
 Rear lamps, refer to Tail lamps 126  
 Rear-mounted luggage rack 101  
 Rear seats  
 – adjusting head restraints 38  
 – folding down backrests 91  
 Rearview mirror, refer to Mirrors 41  
 Rear window defroster 81, 84  
 Recirculated-air mode 80, 83  
 Recirculation of air, refer to Recirculated-air mode 80, 83  
 Reflectors, refer to Tail lamps 126  
 Refueling 104  
 Releasing  
 – hood 114  
 Remaining distance, refer to Cruising range 58



Remote control **18**  
– battery renewal **27**  
– convenient access **26**  
– garage door opener **85**  
– luggage compartment lid **20**  
– malfunctions **21, 27**  
– removing from the ignition lock **47**  
– service data **118**  
Remote control key, refer to Integrated key/remote control **18**  
Replacement fuses, refer to Fuses **128**  
Replacement remote control **18**  
Replacing bulbs, refer to Lamps and bulbs **124**  
Replacing tires, refer to New wheels and tires **112**  
Reporting safety defects **6**  
Reserve warning, refer to Fuel gauge **57**  
Reservoir for washer systems **53**  
Residual heat **83**  
Restraint systems, refer to Safety belts **41**  
Restraint systems for children **44**  
Retreaded tires **112**  
Reverse gear  
– automatic transmission with Steptronic **50**  
– manual transmission **49**  
Roadside Assistance **130**  
Roadside parking lamps **76**  
– replacing bulbs **125**  
Roadworthiness test, refer to Service requirements **61**  
Rollover protection system, convertible **72**  
– resetting **73**  
Roof load capacity **149**  
Roof-mounted luggage rack **100**  
Rope, refer to Tow-starting, towing away **133**

RSC Runflat System  
Component, refer to Run-Flat Tires **112**  
Runflat System Component  
RSC, refer to Run-Flat Tires **112**  
Run-Flat Tires **112**  
– continuing driving with a damaged tire **67**  
– flat tire **67**  
– new tires **112**  
– remaining driving distance, refer to Indication of a flat tire **67**  
– tire inflation pressure **106**  
– winter tires **113**  
Runflat Tyres, refer to Run-Flat Tires **112**

## S

Safety-belt height adjustment **41**  
Safety belts **41**  
– damage **41**  
– indicator lamp **41**  
– reminder **41**  
– sitting safely **35**  
Safety systems  
– airbags **71**  
– Antilock Brake System ABS **64**  
– Dynamic Stability Control DSC **65**  
– rollover protection system, convertible **72**  
– safety belts **41**  
Safety tires, refer to Run-Flat Tires **112**  
Saving fuel **96**  
Screw thread for tow fitting **132**  
Seat and mirror memory **39**  
Seat belt reminder, refer to 'Fasten safety belts' reminder **41**  
Seats **35**  
– heating **39**  
– sitting safely **35**  
Securing cargo **92, 93**  
Selector lever, automatic transmission with Steptronic **50**  
Service, refer to Roadside Assistance **130**  
Service car, refer to Roadside Assistance **130**  
Service data in remote control **118**  
Service Interval Display, refer to Condition Based Service CBS **118**  
Service requirement display, refer to Condition Based Service CBS **118**  
Service requirements **61**  
Settings  
– clock, 12h/24h format **60**  
– date format **60**  
Shifting gears with automatic transmission with Steptronic **50**  
Shiftlock, refer to Changing selector lever positions **50**  
Side airbags **71**  
Side windows, refer to Windows **27**  
Signal horn, refer to Horn **10**  
Sitting safely **35**  
– airbags **35**  
– safety belt **35**  
Ski bag **92**  
Sliding/tilt sunroof, refer to Glass roof, electric **29**  
Slot for remote control **47**  
Smokers' package, refer to Ashtray **90**  
Snap-in adapter, refer to Center armrest **88**  
Snow chains **113**  
Socket, refer to Connecting electrical appliances **90**  
Socket for On-Board Diagnosis OBD **119**  
Spare fuses **128**  
Special oils, refer to Specified engine oils **116**  
Specified engine oils **116**

- Speed
    - for winter tires [113](#)
  - Speed display, refer to [Speedometer 12](#)
  - Speedometer [12](#)
  - Sport program, automatic transmission with [Steptronic 50](#)
  - Spray nozzles, refer to [Windshield washer nozzles 53](#)
  - Stability control, refer to [Driving stability control systems 64](#)
  - Start/stop button [47](#)
    - starting the engine [48](#)
    - switching off the engine [48](#)
  - Starting, refer to [Starting the engine 48](#)
  - Starting assistance, refer to [Jump starting 131](#)
  - Starting the engine
    - start/stop button [47](#)
  - Status of this Owner's Manual at time of printing [5](#)
  - Steam jet [120, 121](#)
  - Steering wheel [43](#)
    - adjustment [43](#)
    - buttons on steering wheel [11](#)
    - heating [43](#)
  - Steering with variable ratio, refer to [Active steering 70](#)
  - Steptronic, refer to [Automatic transmission with Steptronic 49](#)
  - Storage [123](#)
  - Storage compartment package [89](#)
  - Storage compartments [89](#)
  - Storing
    - seat position, refer to [Seat and mirror memory 39](#)
    - telephone numbers, refer to [separate Owner's Manual](#)
  - Storing tires [113](#)
  - Stowage, refer to [Storage compartments 89](#)
  - Summer tires, refer to [Wheels and tires 106](#)
  - Switches, refer to [Cockpit 10](#)
  - Switching off
    - engine [48](#)
  - Switching off the engine
    - start/stop button [47](#)
  - Switching the cooling function on and off [84](#)
  - Symbols [4](#)
- T**
- Tachometer [56](#)
  - Tail lamp, refer to [Tail lamps 126](#)
    - replacing bulb [127](#)
  - Tail lamps [126](#)
    - replacing bulb [127](#)
  - Tank contents, refer to [Capacities 150](#)
  - Technical changes [5](#)
  - Technical data [146](#)
  - Telephone, installation location, refer to [Center armrest 88](#)
  - Telephone, refer to [separate Owner's Manual](#)
  - Temperature, setting for automatic climate control [81, 82](#)
  - Temperature display
    - outside temperature [56](#)
    - outside temperature warning [56](#)
    - setting the units [60](#)
  - Tempomat, refer to [Cruise control 54](#)
  - Thigh support [36](#)
  - Third brake lamp, refer to [Center brake lamp 127](#)
  - Three-point safety belt [41](#)
  - Through-loading system [91](#)
  - Tilt alarm sensor [25](#)
  - Tilt function, passenger-side mirror [42](#)
  - Tire inflation pressure [106](#)
    - loss [67](#)
  - Tire pressure monitoring, refer to [Flat Tire Monitor 66](#)
  - Tire Pressure Monitor TPM [68](#)
    - resetting the system [68](#)
    - system limitations [68](#)
    - warning lamp [69](#)
  - Tire puncture, refer to [Flat Tire Monitor 67](#)
  - Tire Quality Grading [110](#)
  - Tires
    - age [110, 112](#)
    - air loss [69](#)
    - breaking in [96](#)
    - changing, refer to [Changing wheels 127](#)
    - condition [111](#)
    - damage [111](#)
    - inflation pressure [106](#)
    - labels [110](#)
    - minimum tread depth [111](#)
    - new tires [112](#)
    - pressure monitoring, refer to [Flat Tire Monitor 66](#)
    - pressure monitoring, refer to [Tire Pressure Monitor TPM 68](#)
    - puncture [67](#)
    - retreaded [112](#)
    - Run-Flat Tires [112](#)
    - size [110](#)
    - wear indicators, refer to [Minimum tread depth 111](#)
    - winter tires [113](#)
  - Tools, refer to [Onboard tool kit 124](#)
  - Torque, refer to [Engine data 146](#)
  - Tow bar [133](#)
  - Tow fitting [132](#)
  - Tow fittings for tow-starting and towing away [132](#)
  - Towing [132](#)
    - car with automatic transmission [132](#)
    - methods [133](#)
  - Towing and tow-starting [132](#)
  - Tow rope [133](#)
  - Tow-starting [132](#)

TPM, refer to Tire Pressure Monitor **68**  
Traction control, refer to Dynamic Stability Control DSC **65**  
Transmission  
– automatic transmission with Steptronic **49**  
– manual transmission **49**  
Transporting children safely **44**  
Transport securing devices, refer to Securing cargo **100**  
Tread depth, refer to Minimum tire tread **111**  
Trip-distance counter, refer to Trip odometer **56**  
Triple turn signal activation **52**  
Trip odometer **56**  
Trunk, refer to Cargo bay  
Trunk lid, refer to Luggage compartment lid **23**  
Turn, indicating  
– triple turn signal **52**  
Turning circle, refer to Dimensions **147**  
Turn signals **51**  
– indicator lamp **12**  
– replacing bulbs **126**  
Tying down loads, refer to Cargo loading **100**

## U

Underbody protection, refer to Caring for your vehicle  
Uniform Tire Quality Grading/UTQR **110**  
Units of measure  
– average fuel consumption **60**  
– temperature **60**  
Universal garage door opener, refer to Integrated universal remote control **85**  
Universal remote control **85**  
Unlatching, refer to Unlocking **19**

Unlocking  
– from inside **23**  
– from outside **19**  
– luggage compartment lid **27**  
– without remote control, refer to Convenient access **26**  
Unlocking without a key, refer to Convenient access **26**

## V

Vehicle  
– battery **128**  
– breaking in **96**  
– cargo loading **99**  
– decommissioning, refer to Vehicle storage  
– dimensions **147**  
– Identification Number, refer to Engine compartment **115**  
– parking **48**  
– weight **149**  
Vehicle jack **128**  
Vehicle storage **123**  
Ventilation **81, 84**  
– draft-free **81, 84**  
Vents, refer to Air vents **79**  
Vents, refer to Ventilation **81, 84**  
Volume  
– fuel tank, refer to Capacities **150**

## W

Warm  
– steering wheel **43**  
Warning and indicator lamps **13, 134**  
Warning messages, refer to Check Control **62**  
Warning triangle **131**  
Washer fluid **53**  
– content of the reservoir **53**  
Washer fluid filler neck **53**  
Waste tray, refer to Ashtray **90**  
Water on roads, refer to Driving through water **98**  
Water penetration **120, 121**

Wear indicators in tires, refer to Minimum tread depth **111**  
Weights **149**  
Welcome lamps **74**  
Wheelbase, refer to Dimensions **147**  
Wheels, new **112**  
Wheels and tires **106**  
Width, refer to Dimensions **147**  
Windows **27**  
– convenient operation **20**  
– convenient operation with convenient access **26**  
– opening, closing **27**  
– pinch protection system **28**  
Windows, defrosting and removing condensation **81, 84**  
Windshield  
– cleaning **53**  
– defrosting and removing condensation **81, 84**  
Windshield wash  
– filling capacity, reservoir **150**  
Windshield washer reservoir, refer to Washer fluid filler neck **53**  
Windshield washer system **52**  
– washer fluid **53**  
– washer nozzles **53**  
Windshield wiper blades, changing **124**  
Windshield wipers, refer to Wiper system **52**  
Winter tires **113**  
– storage **113**  
Wiper blade replacement **124**  
Wiper system **52**  
Wrench/screwdriver, refer to Onboard tool kit **124**

## X

Xenon lamps  
– replacing bulb **124**





More about BMW

[bmwusa.com](http://bmwusa.com)



The Ultimate  
Driving Machine

01 41 2 600 853 ue Basis

