

LUBRICATION SYSTEM

DESCRIPTION OF LUBRICATION SYSTEM	B-2
OIL PAN	B-3
DISASSEMBLY/ASSEMBLY	B-3
OIL FILLING	B-5
OIL STRAINER ASSEMBLY	B-5
DISASSEMBLY/ASSEMBLY	B-5
OIL PUMP AND FRONT OIL SEAL	B-6
DISASSEMBLY/ASSEMBLY	B-6
OIL FILTER AND OIL PRESSURE SENSOR	B-10
DISASSEMBLY/ASSEMBLY	B-10
OIL PRESSURE TESTING PARAMETER LIST	B-11

ENGINE LUBRICATION SYSTEM

DESCRIPTION OF LUBRICATION SYSTEM

—The rotor oil pump (1) at the front end of the crankshaft sucks oil out of the oil pan (3) by oil strainer (2) and pressurizes oil, and then the pressurized oil will enter the full-flow oil filter through the auxiliary oil passage (4) at the left side of the cylinder (view from the front). A relief valve (6) is set up inside the oil pump to control the pressure at the main oil passage. The relief valve opens at $440\text{kpa}+20\text{kpa}$, and the filtered oil flow from the center hole in oil filter through the center hole of the filter terminal to the engine main oil passage.

—The main oil passage lubricate the main bearing through holes on the cylinder block and lubricate the connecting-rod bearing through the oil passage inside the crank shaft.

—On the side of the vent pipe of the connecting-rod bearing is a small oil hole from where oil will eject to lubricate piston pin and cylinder.

—Oil pressure sensor (8) is close to oil filter, connected to the main passage through an internal oil passage. And engine oil will be provided upward to the third camshaft journal from the upper oil passage.

—Other camshaft journals get oil from the middle passage of the camshaft, whose ends are sealed with steel balls.

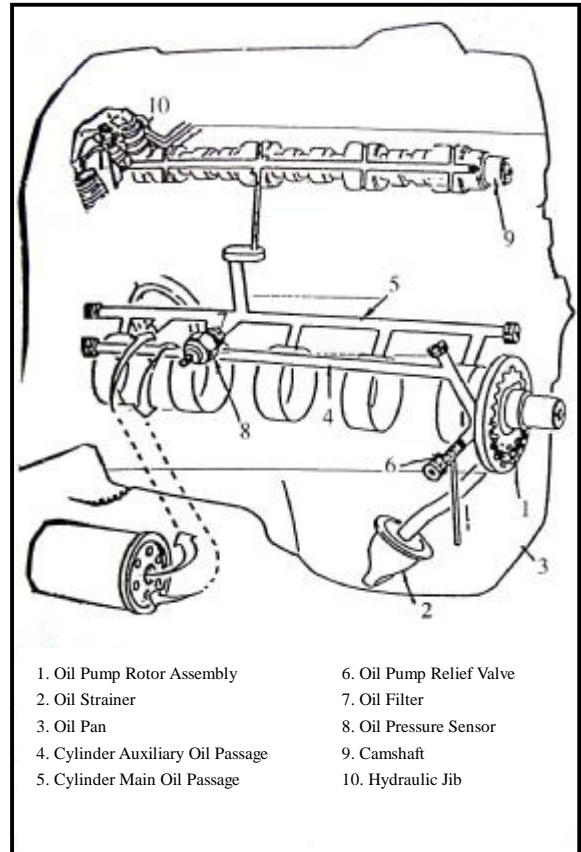

- Hydraulic jib gets oil through the oil passage through which the oil tank at the camshaft supplies oil to the cylinder cap.
- The interface between valve rocker and hydraulic jib is lubricated by oil through the oil hole in hydraulic jib.
- Rocker seat is lubricated by oil through cylinder cap oil passage. The interface between valve small end and rocker is lubricated through splashes.

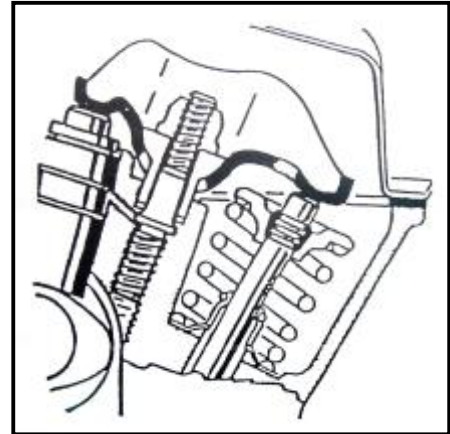

OIL PAN

Disassembly:

- To unscrew the oil-tapping bolt and empty the pan.
- To unscrew 18 M6X20 bolts.
- To take out the oil pan gasket.
- To check if both reinforcing pads are clamped tightly on the back of the oil pan flange.



Assembly:

- To spread Letai 598 seal glue or GY409 anaerobic glue on the connecting areas between cylinder oil pan flange and oil pump body and rear oil seal support.

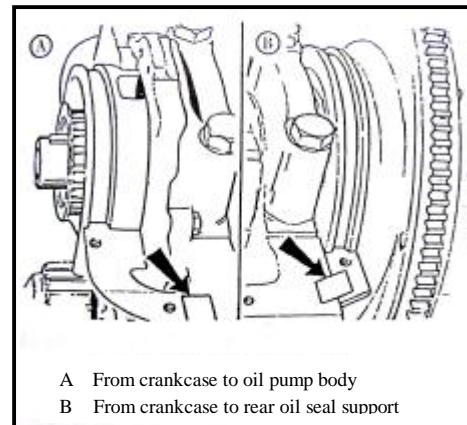

- To put the new rubber gasket on the cylinder body, placing both ends of the gasket into the rear oil seal support and oil pump rut.
- To install oil pan, placing both ends of the gasket into oil pan rut.
- To screw up the bolts (the bolts shown in the up left figure first) manually.
- To screw up the bolts to 5.0 – 8.0N.m in order as shown in the left figure.

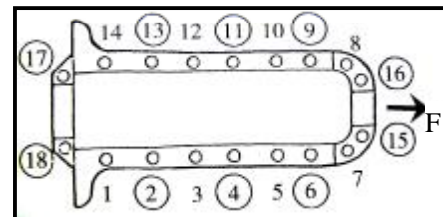

OIL FILLING

- To fill the engine with $3.1 \pm 0.15L$ of oil (SAE10W/30SF grade, or SAE5W/30SJ grade at temperature lower than $-18^{\circ}C$)
- The oil surface shall be between “max” and “min” on the dipstick.



OIL STRAINER ASSEMBLY

Disassembly:

- To unscrew the locknut of the oil strainer support and take out the nut and gasket.
- To unscrew and take out the support bolt.
- To unscrew oil strainer flange bolts (two) and take out two gasket bolts with spring.



- To install the new oil strainer gasket to the oil pump flange, setup the oil strainer assembly and screw up two bolts with gaskets. — To screw the oil strainer support to the cylinder using M8 bolts, put the support onto the stud on the left of the second main bearing cap, place back the flat washer and screw up the nuts manually.
- To screw up the oil strainer flange bolt to 8-12N.m.
- To screw up the support bolt to 17-23N.m.
- To screw up the locknut to 17-23N.m

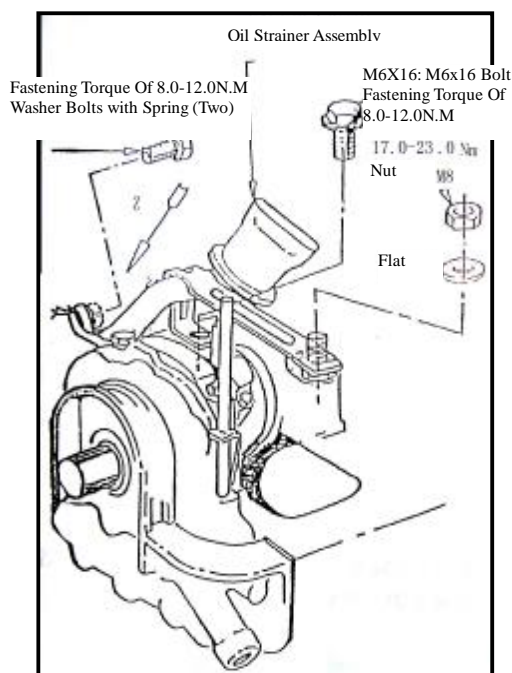

OIL PUMP AND FRONT OIL SEAL

Disassembly:

- To unscrew and take out six M6X30 hexagon flange bolts.
- To take out oil pump and front oil seal assembly.



- To use a screwdriver or chisel to take out the crankshaft front oil seal and pay attention not to touch or damage the front oil seal.

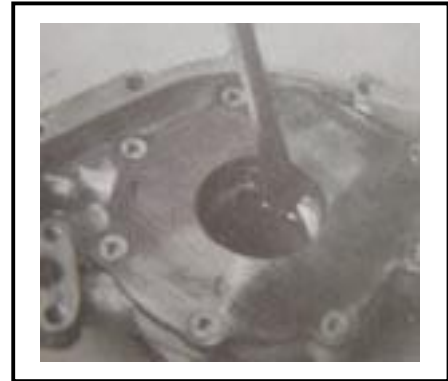

- To take out 7 M6 bolts (as indicated by the arrows in the figure).

- To demount the oil pump cover plate.

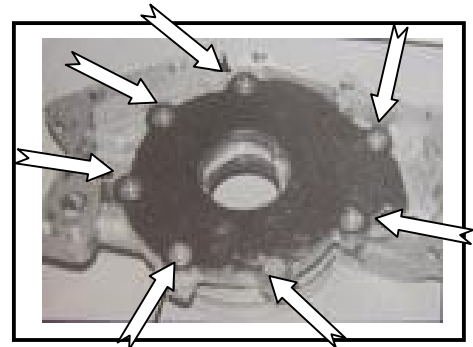

—To take out the internal and external rotors.

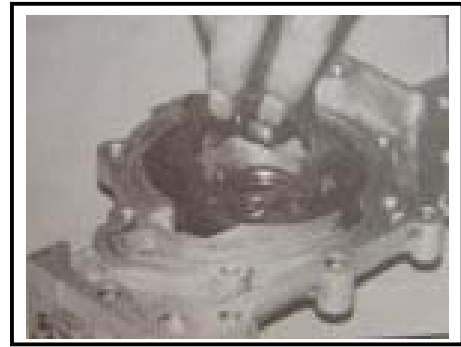

—To check out the clearance between the pump external rotor and pump body. The oil pump external rotor shall have a clearance of 0.06-0.19mm with oil pump body.

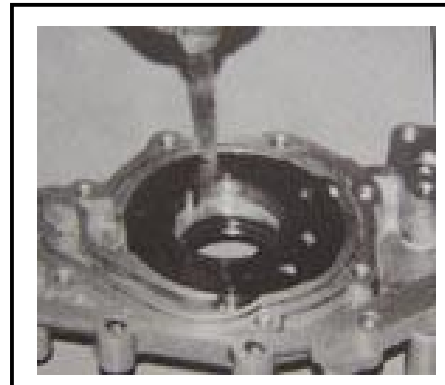

—To check out the radial clearance between oil pump internal rotor and external rotor. The clearance between internal and external rotors shall be 0.05-0.18mm.

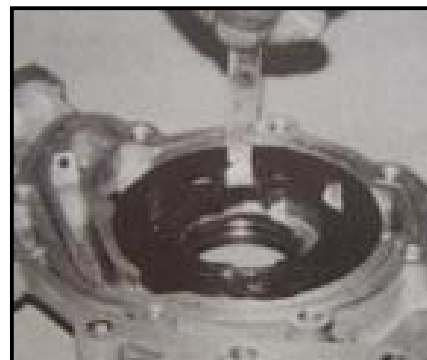

——To check out the rotor end clearance.

The rotor end clearance shall be 0.014-0.100mm.

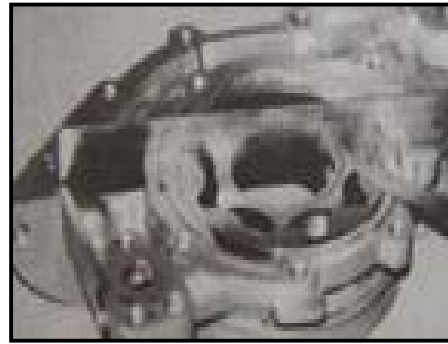

——To unscrew and take out the horizontal internal hexagon bolts (small ones).

——To take out relief valve spring and relief valve ball.

——To check out the spring load and free length.

The free length is 46mm;

The spring load is $32.8\text{N} \pm 2\text{N}$ at 29mm;

The installation length of relief valve spring is 38.5mm.

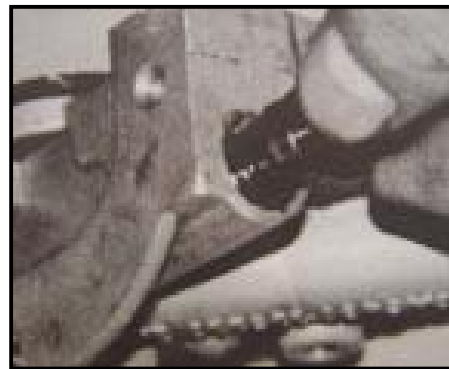

——Bad relief valve spring, if any, has to be changed.



Assembly:

—To place external and internal rotors into the oil pump body, making sure the installation marks on the external and internal rotors are upward.

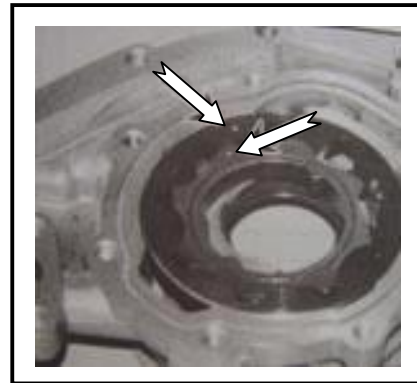

—To place the oil pump cover plate onto the oil pump, screw up the 7 bolts to 7-10N.m.

—To install the relief valve and relief spring into the oil pump hole.

—To screw the bolt into the oil pump body to 20-25N.m.

—To use oil to adhibit the new oil pump gasket to the front end of the cylinder body.



—To mount the oil pump to the front end of the crankshaft, pointing to the internal hole of the internal rotors.

—To screw up the six installation nuts manually.

—To check out and adjust evenness between the oil pump bottom and cylinder oil pan flange to the range of $\pm 0.26\text{mm}$.

—To screw tightly the oil pump set bolts to 8-11N.m.

— To spread engine lubrication oil on the crankshaft oil seal journal.

—To cover the crankshaft oil seal journal with a thin plastic strip to prevent damages to crankshaft oil seal edge.



— To spread engine lubrication oil onto the crankshaft oil seal edge and use appropriate sleeve and crank belt wheel and belt wheel to screw tightly the bolts and washers to press the oil seal in place.

——To remove the thing plastic strip.

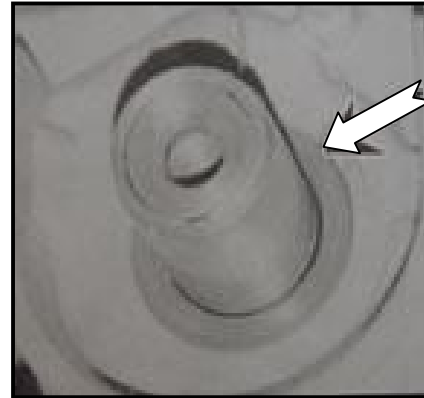

OIL FILTER AND OIL PRESSURE SENSOR

Disassembly:

——To demount the oil filter by rotating the filter counterclockwise.

——To remove the oil pressure sensor.



Assembly:

——To spread engine lubrication oil onto the oil filter gasket and screw it up to the fitting to 12-17N.m., or screw the oil filter manually and screw more 3/4-1 round when the rudder gasket reaches the cylinder.

——To spread Letai 243 seal glue onto the oil pressure sensor screw threads and screw it to the cylinder main oil passage to 25-29N.m.

Oil pressure sensor screw threads are 1/4" -18NPTF.

The supply voltage of oil pressure sensor is 6-24V.

The alarm triggering pressure is 30 ± 15 Kpa.

8.0-25.0N.M Fastening Torque Of 8.0-25.0N.M

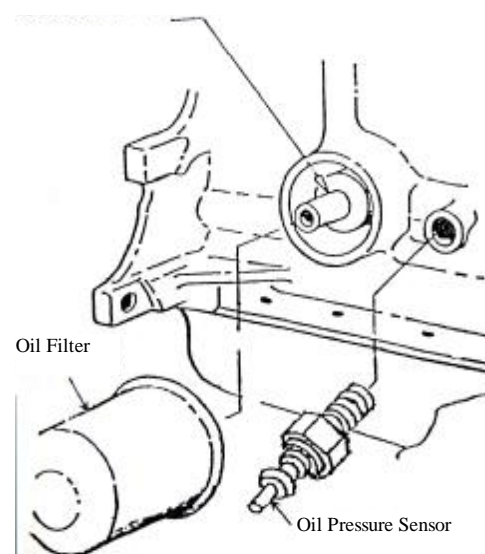

OIL PRESSURE TESTING PARAMETER LIST

Serial No.	Subject	Rev r/min	Pressure Kpa (Kgf/cm ²)	Judgment	Index Achievement
1	Oil Yield Starting Time (s)	200		Oil yield starting	≤4
2	Oil output (L/min)	800	196 (2)		>6
	Oil output (L/min)	3000	294 (3)		>28
3	Opening Pressure of Pressure Limit Valve: Kpa (Kgf/cm ²)	2000		Oil yield starting	440±20 (4.49±0.2)
4	Seal		686 (7.0)	No oil leakage on each faying face	Passed