

Service.

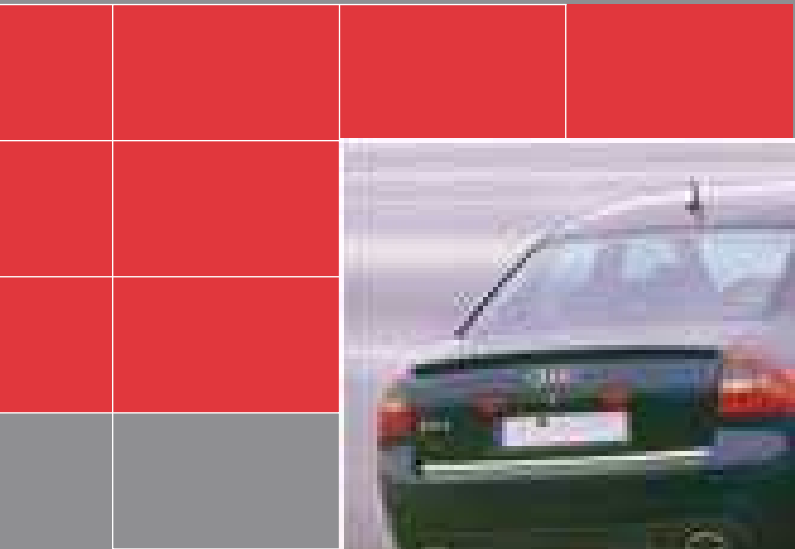

AUDI RS 6

Self Study Programme 244

The Audi RS 6 is the top model in the Audi A6-Series and sets new standards in the high-performance vehicle segment.

It is available either as

Saloon or Avant.

Despite outstanding high performance, the vehicle's outward appearance reflects a certain degree of restraint to suit the tastes of its discerning buyers.

Its discreet features include a low-slung front apron with three large air inlets in RS 6 design, option of 18 or 19-inch light alloy wheels and exterior mirror housings in matt brushed aluminium.

The sporty appearance is underscored by the new design of the sill panels and rear spoiler, as well as the powerful character of the rear end with oval tailpipes made of stainless steel.

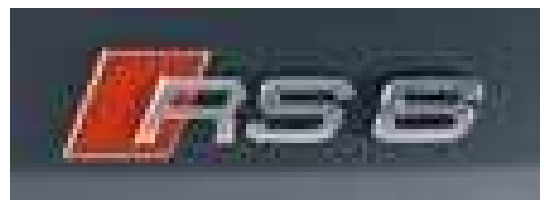

This Self Study Programme deals exclusively with the special features of the Audi RS 6.

	Page
Brief Outline	4
Body	
Sill panels	6
Jacking points	7
Front end	8
Engine compartment noise insulation	8
Engine compartment	9
Rear spoiler for Saloon	10
Rear spoiler for Avant	11
Engine and Gearbox	
Audi RS 6 engine	12
Crankshaft group	14
Cylinder head	15
Oil circuit	17
Air routing	18
Crankcase breather	20
ACF system	21
Secondary-air system	22
Charge-pressure control	22
Divert air control	23
Cooling system	24
Fans	25
Coolant circuit	26
Oil cooling	28
Fuel system	30
Exhaust system	33
Gearbox	35
System layout	38
CAN data exchange	40
Running Gear	
Front axle	42
Rear axle	44
Dynamic Ride Control – DRC	46
Air Conditioner	51
Service	
Service concept	52
Special tool	52
Technical data	54

The Self Study Programme contains information on design features and functions.

The Self Study Programme is not intended as a Workshop Manual. Values given are only intended to help explain the subject matter and relate to the software version applicable at the time of SSP compilation.

Use should always be made of the latest technical publications when performing maintenance and repair work.

New



Attention Note





The Audi RS 6

The arrival of the Audi RS 6 has given a whole new meaning to the term "vehicle dynamics". As was the case with the Audi RS4, the new top model in the Audi A6 Series was conceived by Audi's star designers at quattro® GmbH and developed in conjunction with Audi AG.

The quattro® four-wheel drive Audi RS 6 has a 4.2 litre V8 engine with two turbochargers, five valves per cylinder and twin charge-air cooling.

The power output of 331 kW/450 hp thus achieved at a maximum torque of 560 Nm combined with a tiptronic® 5-speed automatic gearbox produces agility worthy of a sports car – accelerating from 0 to 100 km/h in only 4.9 seconds.

An exceptional feature is the manual gearbox control via paddles on the steering wheel, adding a touch of formula 1 atmosphere.

Thanks to the new dual-flow exhaust system employing metal substrate technology for primary and main catalytic converters, the vehicle satisfies the requirements of the EU 3 emission standard.





For the first time, use is made in the Audi RS 6 of the hydraulic active running gear system Dynamic Ride Control (DRC).

This damper system more or less totally eliminates the body roll and pitch encountered on cornering.

A brake system with disc diameters of 365 mm (front) and 335 mm (rear) ensures corresponding deceleration.

With its high-grade materials, the exclusive interior equipment of the Audi RS 6 combines a sporty atmosphere and excellent comfort.

Standard features include leather, heated Recaro sports seats, carbon appliqué work on the dash panel and door trim, Concert radio with Bose® sound system, xenon-plus headlights, SIDEGUARDS® and Acoustic Parking System.

Navigation/telematics/telephone, 19", 5-arm light alloy wheels and sports seats featuring a combination of leather and Alcantara are available as special equipment.



Neither vehicle version is intended for trailer operation or the installation of an auxiliary heater.



Body

Sill panels



The new sill cover panel is bolted to the underbody as well as the front and rear wings and is attached by means of plastic plugs to the top of the sill.

The side dirt deflectors forming part of the Audi A6 basic equipment are not fitted.

The upper fastening elements of the sill panel trim are concealed by the sill moulding with the RS 6 emblem.

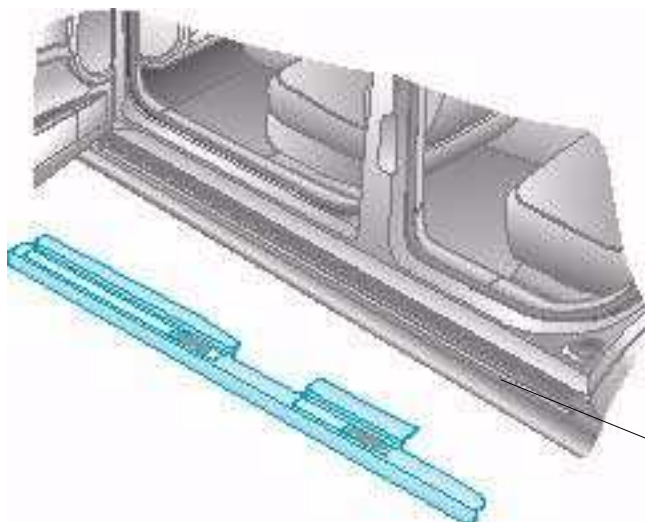

Rail section to accommodate sill moulding

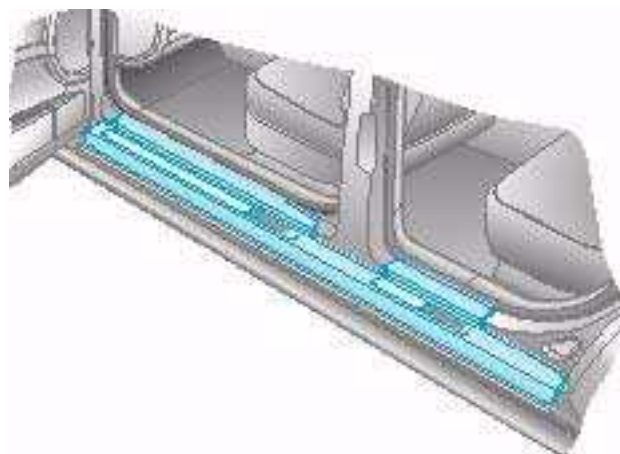

SSP244_007

Jacking points

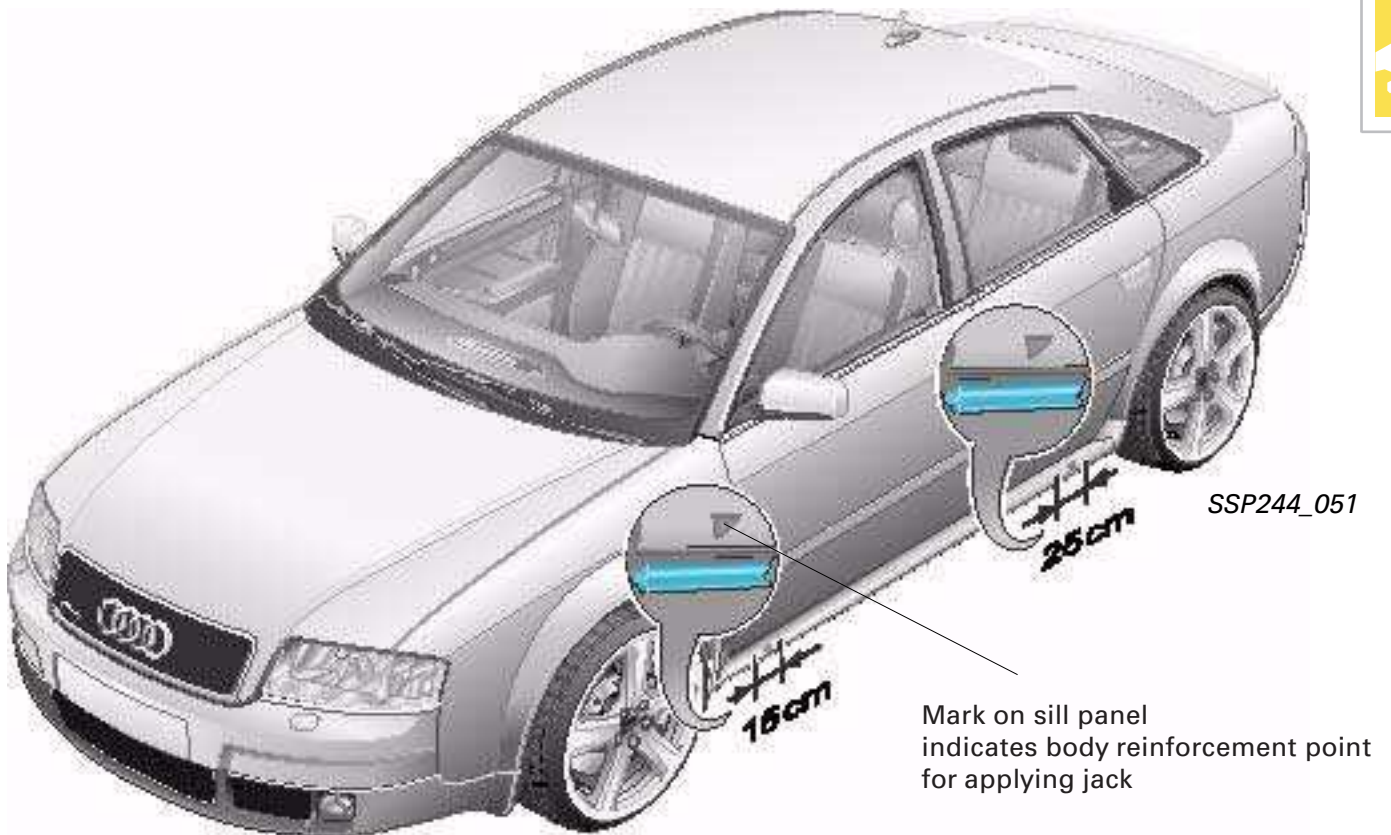

The positions for jack and lifting platform application are marked on each sill panel. The reinforced parts of the body designed to safely withstand the lifting forces are only to be found in this marked area.

! Raising the vehicle at other points could damage body components (e.g. sill panels).

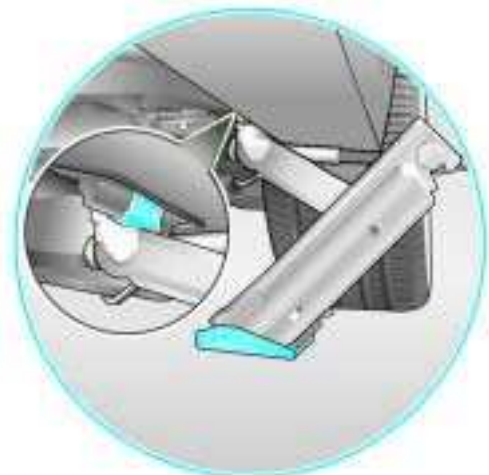

Body

Front end

The front end has been modified in the area of the fog lights and charge-air inlet cover panel.

The screw connection for the front towing eye is located directly behind this cover panel.



Engine compartment noise insulation

To help muffle sound, a noise insulation plate is fitted on the underside of the engine compartment.

The three centre vents play an essential part in providing the large amount of additional cooling air required for the engine and gearbox and supplying this to the engine compartment.

The flow of air is specifically directed to units subject to high thermal load.

The two side vents enable the turbocharger cooling air to escape.

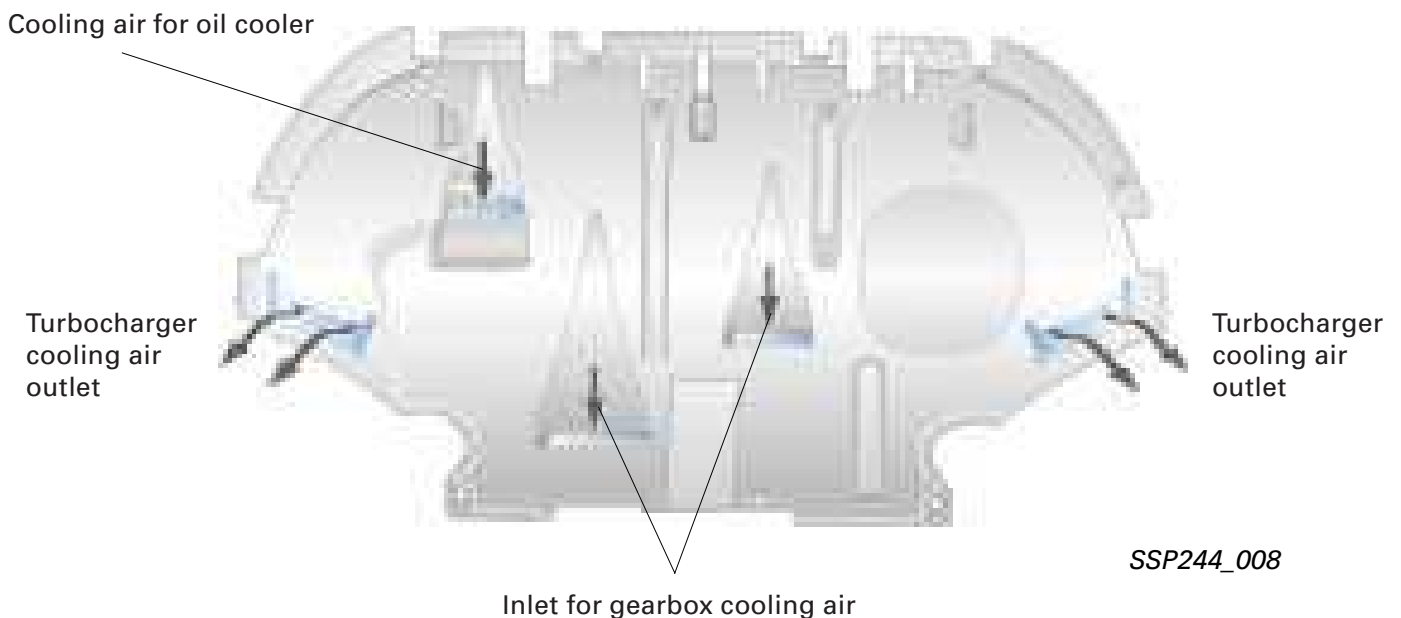

Engine compartment

The coolant expansion tank and brake fluid reservoir have been relocated to the plenum chamber.

The levels in the expansion tank and reservoir can be checked in the usual manner after removing the two covers.



Coolant expansion tank

Brake fluid reservoir tank



SSP244_045

SSP244_046

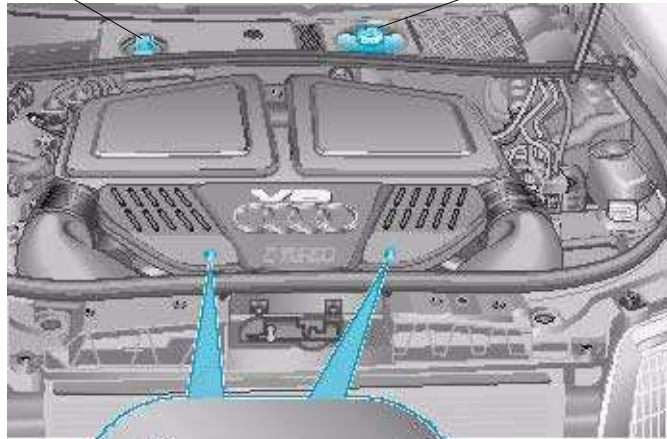

Locking pin (cap open)

SSP244_044

The engine oil filler neck is located on the left side beneath the front engine compartment cover.

The two cover locking pins are released/engaged by brief tapping.

The cover can be tilted and lifted out.

Positioning pins in air cleaner housing

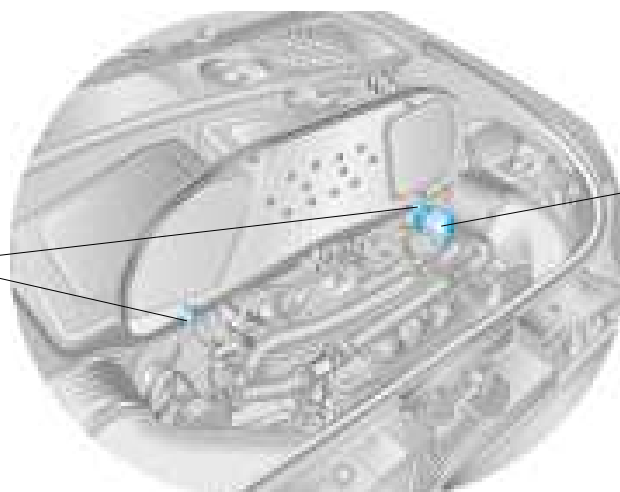

Oil filler neck

SSP244_047

Body

Rear spoiler for Saloon



As with all sports vehicles for the German market, the Audi RS 6 requires a spoiler to reduce lift.

On account of the speed restrictions applying, the spoiler is only available as an option for models for the rest of the world.

On the Saloon version, the spoiler is attached to the boot lid using four bolts.

To achieve an even form fit on the boot lid contour, it is secured by means of all-round double-sided bonding.

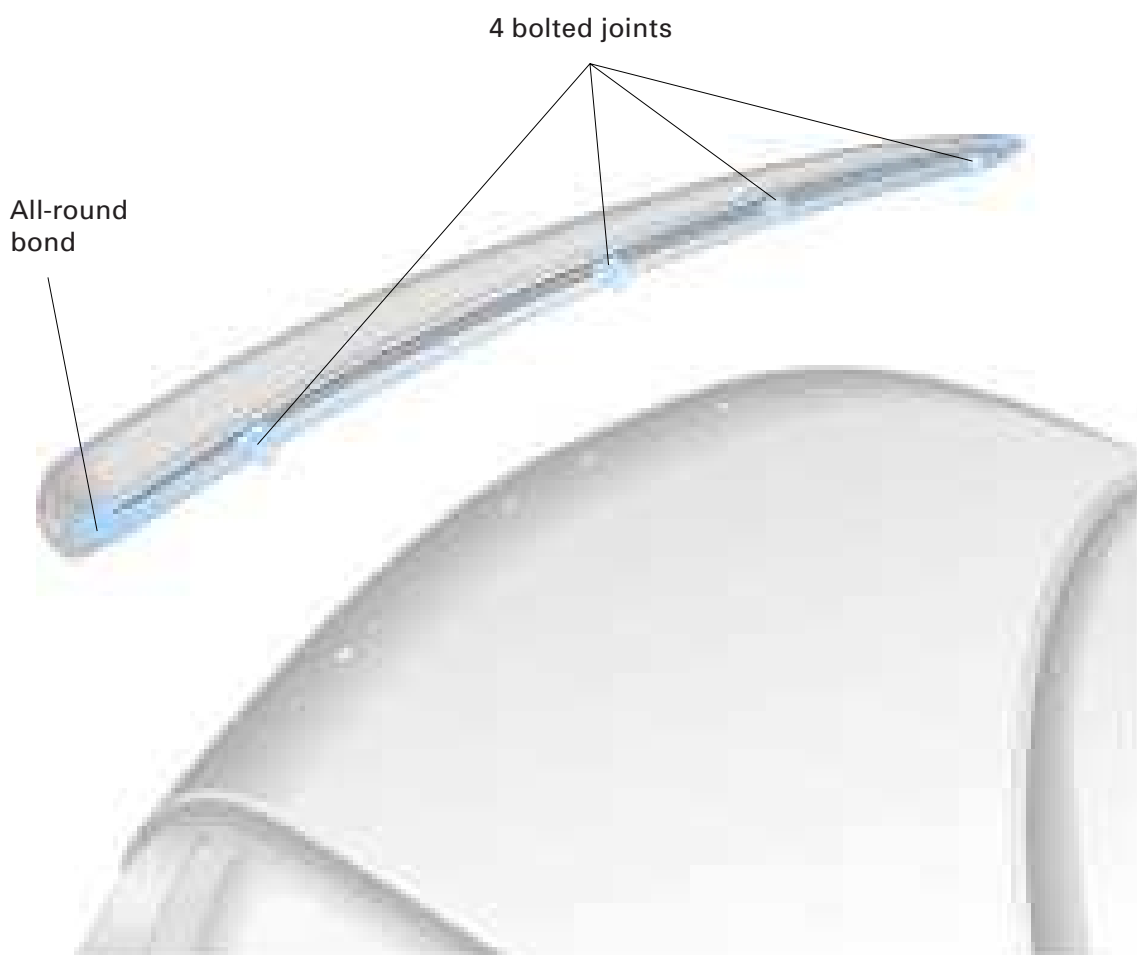

SSP244_019

Rear spoiler for Avant

Like the Saloon, the Avant is also provided with a spoiler, which not only reduces vehicle lift, but also helps to keep the rear window cleaner.

In contrast to the four-bolt attachment method for the Saloon, use is only made of one bolt in each outer section for the Avant. The centre section of the spoiler is additionally secured to the tailgate by two plugs, which at the same time permit compensation for lateral offset between the holes in the tailgate.

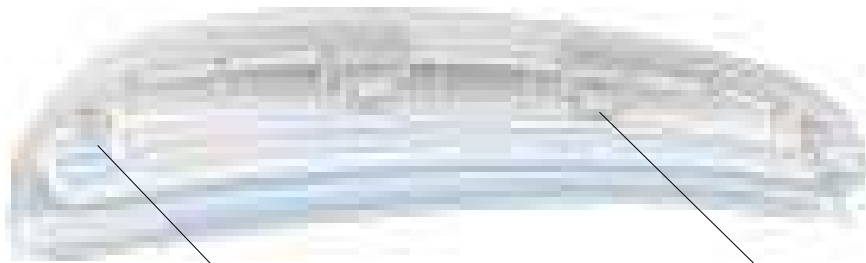

Bolt and positioning element on right and left of spoiler

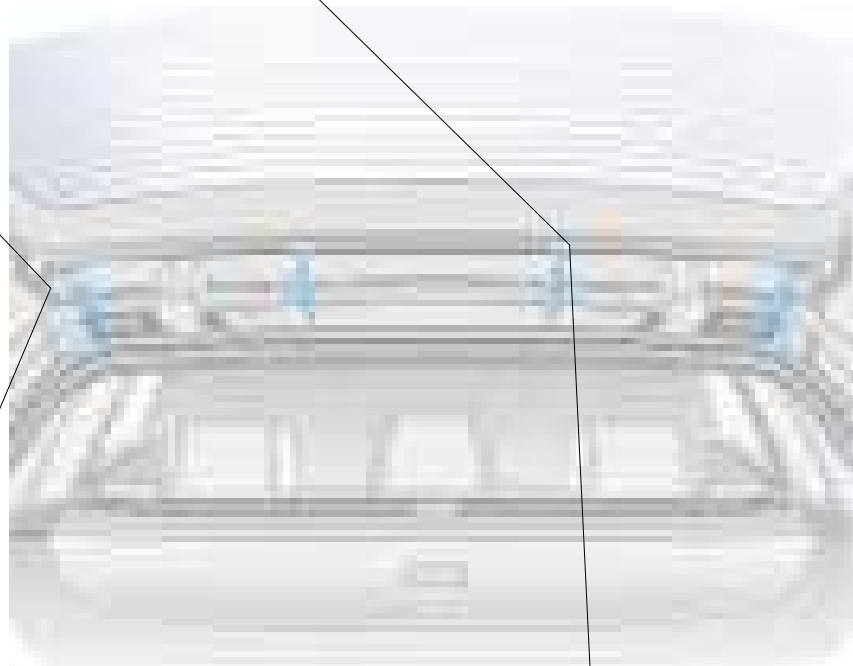

2 centre securing plugs with compensating function



Engine and Gearbox

Audi RS 6 engine

4.2 l bi-turbo (331 kW)

The engine was developed on the basis of the 250 kW V8 engine of the Audi S6.

The aim was to create an engine achieving a high torque level at a low engine speed.



SSP244_002

Technical data

Code letters:	BCY
Type:	8-cyl. 5-valve four-stroke bi-turbo petrol engine in 90° V arrangement
Power:	331 kW/450 hp at 5700 - 6400 rpm
Torque:	560 Nm at 1950 - 5600 rpm
Max. engine speed:	6700 rpm (breakaway speed)
Bore:	84.5 x 93 mm
Stroke:	4172 mm
Compression ratio:	9.8 : 1
Firing order:	1 - 5 - 4 - 8 - 6 - 3 - 7 - 2
Weight:	230 kg
Mixture formation:	Motronic ME7.1.1 with charge pressure control, electronic throttle
Emission control:	Secondary-air system, two under-bonnet primary catalytic converters, two main catalytic converters, four Lambda probes
Emission standard:	EU 3
Fuel:	Premium Plus unleaded 98 RON, knock control permits use of 95 RON unleaded fuel

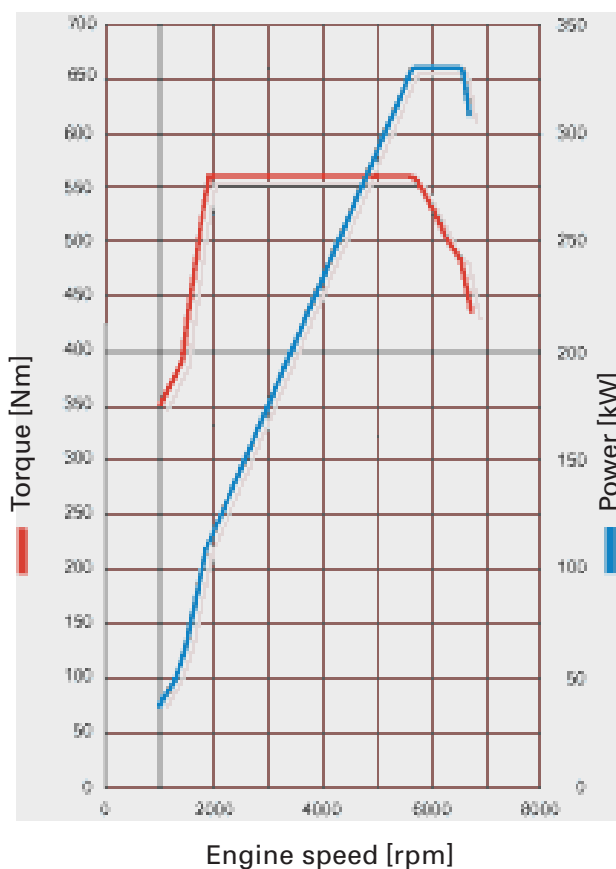

SSP244_001

A sticker indicating the engine code letters is attached to the toothed belt guard (refer to Workshop Manual).



This sticker has to be re-attached if toothed belt guard is replaced as part of repair work.

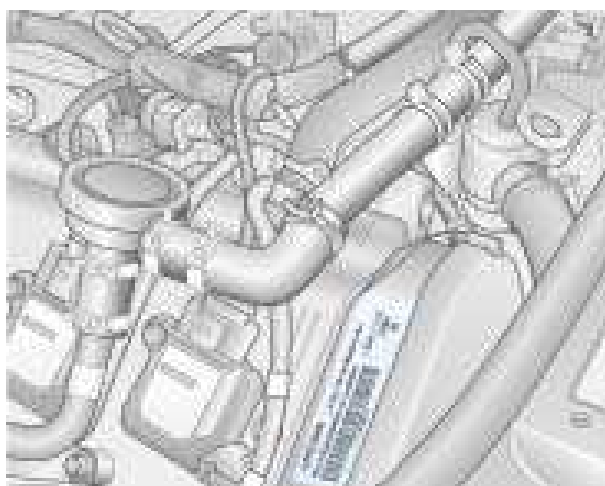

SSP244_009

Engine and Gearbox

Crankshaft group

Crankshaft

Use is made of a standard shaft modified in the flange area.

This is of adequate strength, as the engine speed and hence the inertial forces are relatively low (greater compressive force).

The V8 crankshaft is fitted with a doubly reinforced 10-hole flange drive plate.

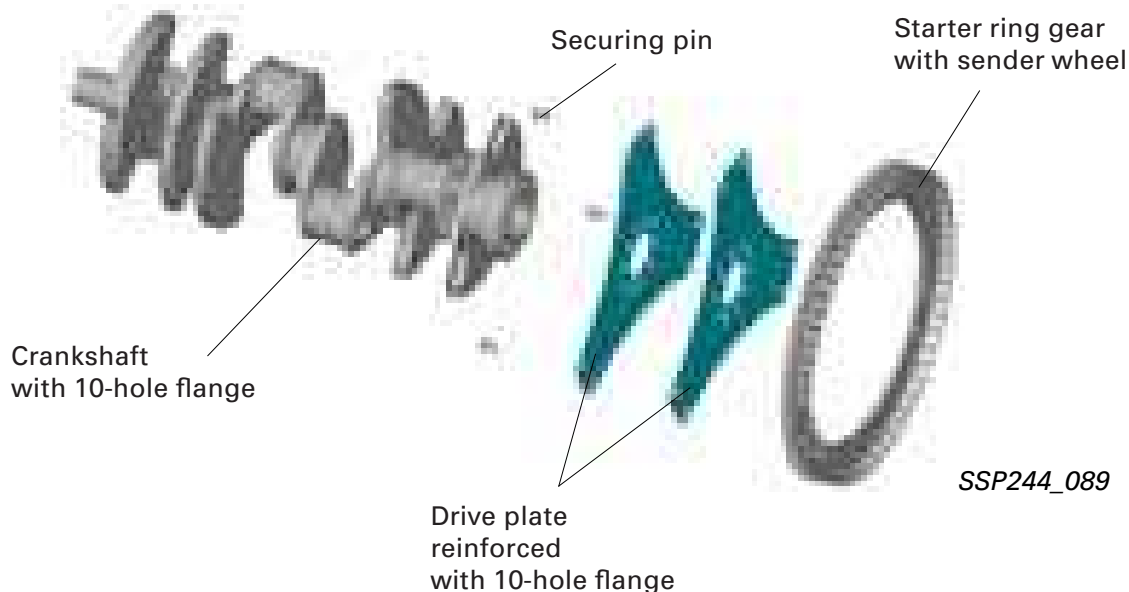

Pistons

The piston skirt is provided with a Ferrostan II bearing surface coating.

The piston design is such that cylinder bank assignment is not necessary.

The compression ratio is reduced to $\epsilon = 9.8$.

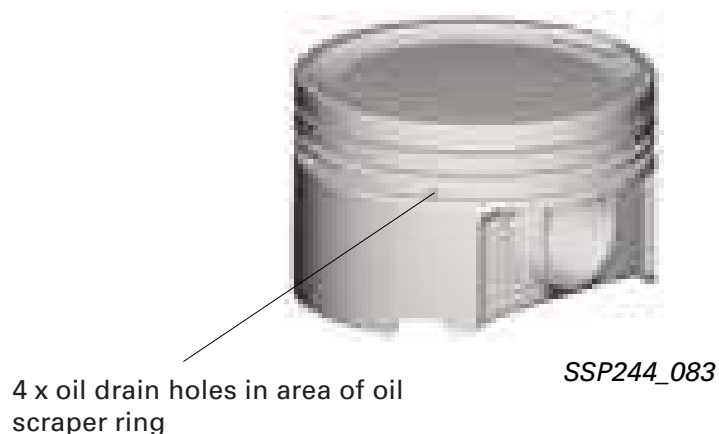

Valves

In the course of reworking the necessary valve throats, the diameters of the two exhaust valves per cylinder and the corresponding seat rings were reduced to $d = 27$ mm.



Cylinder head

Cylinder head gasket

In line with the engine concept, the cylinder head made of a new AlSi alloy is fitted with a four-layer sealing system at the cylinder block and crankcase. The increased power level with charged engines produces higher firing pressures.

Consequently, the gasket materials are an even more important factor in the structural system of the engine. The different profile heights permit optimum force distribution within the components and extend the service life of the sealing beads. As central element, the gaskets are made up of beaded, elastomercoated spring steel layers.

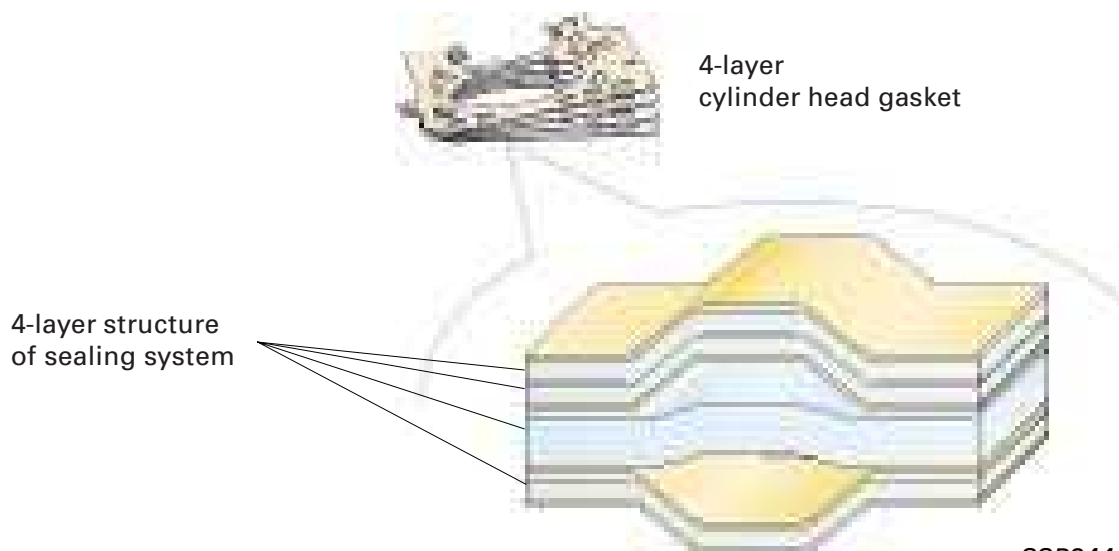
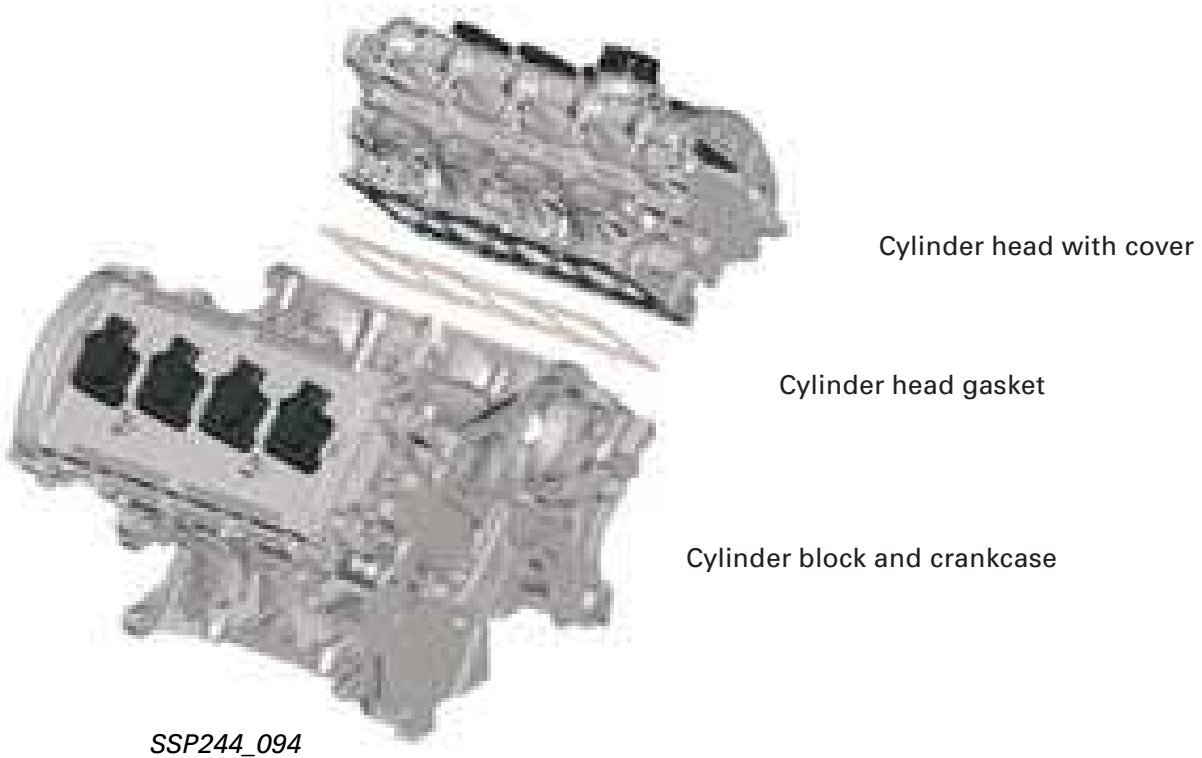

Engine and Gearbox

Cylinder head cooling

The light alloy cylinder head with five valves (three inlet and two exhaust valves per cylinder) has been adapted to meet the more exacting demands through the use of different materials.

In the area of the combustion chambers and exhaust ports, the V8 engine has been fitted with an optimised water jacket for improved heat dissipation. This also necessitated appropriate adaption of the openings in the multi-layer cylinder head gasket for the passage of coolant.

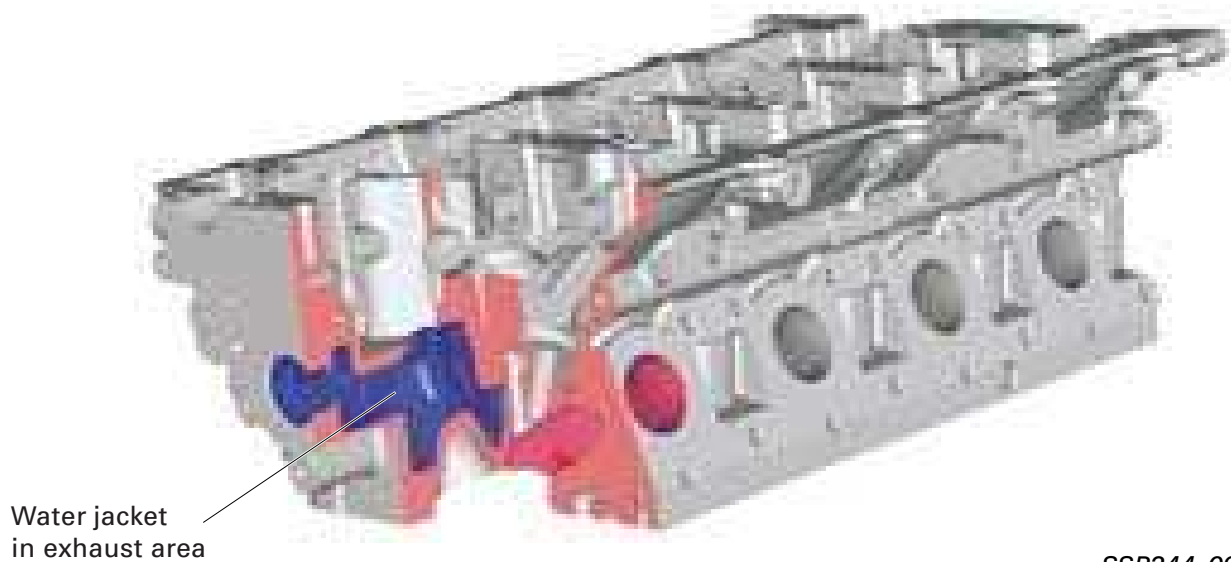

SSP244_091

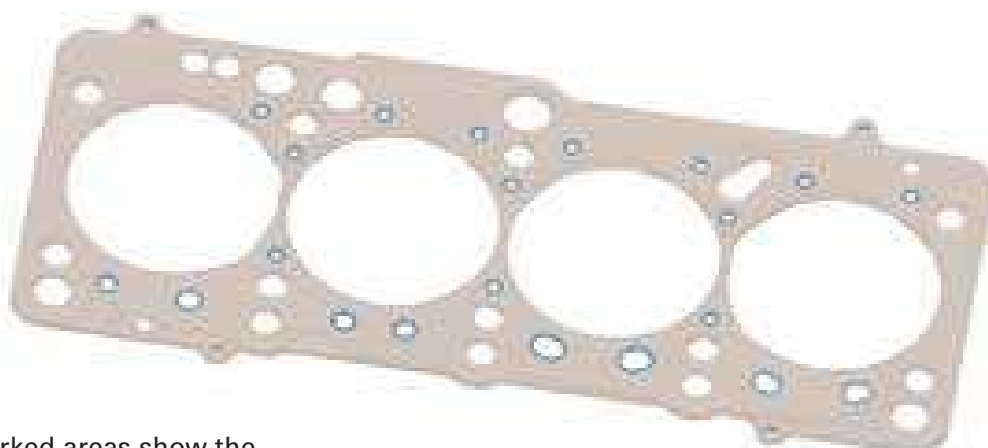

The marked areas show the optimised water openings in the cylinder head gasket.

SSP244_092



On account of the differences in water routing, there are specific cylinder head gaskets for each bank.

Oil circuit

The oil circuit of the Audi RS 6 V8 bi-turbo largely corresponds in terms of design and operation to that of the V8 5V engine (refer also to SSP 217).

Two turbochargers for increased power add to the number of temperatureintensive components in the oil circuit.

A design modification at the oil pump enabled the cut-off pressure in the oil circuit to be increased.

This measure ensures a constant supply and thus also cooling of all engine components.

The resultant increase in oil temperature is dealt with by two separate coolers.

1st circuit - By the familiar oil/water heat exchanger in the oil filter module

2nd circuit - With the air-to-oil cooler located at the front endbeneath the radiator (refer to Page 28)

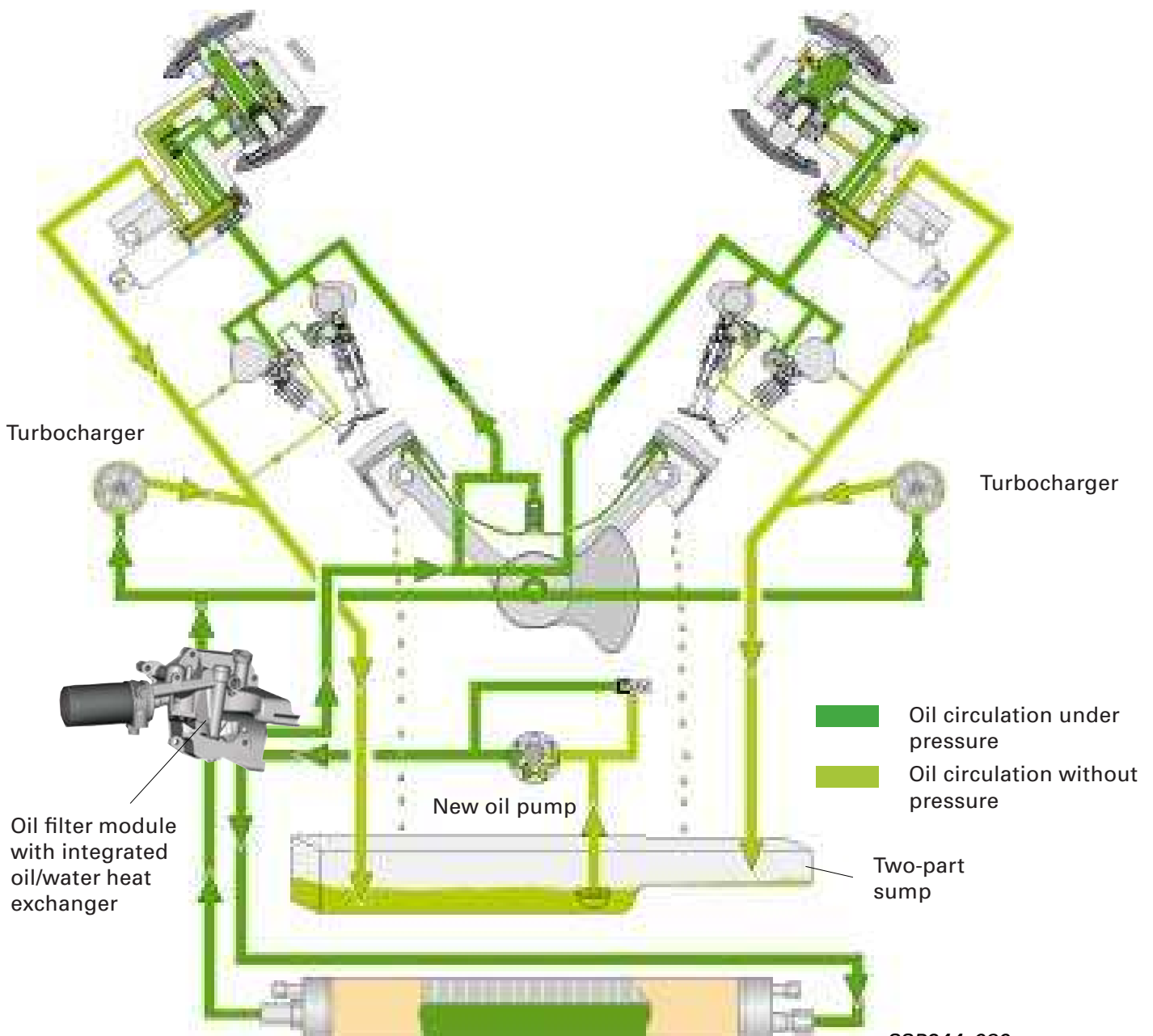

Engine and Gearbox

Air routing

Two new, large air cleaner elements are used to cope with the increased air requirement of the turbo engine.

Cold air is drawn in via two separate inlets in the front end above the radiator.

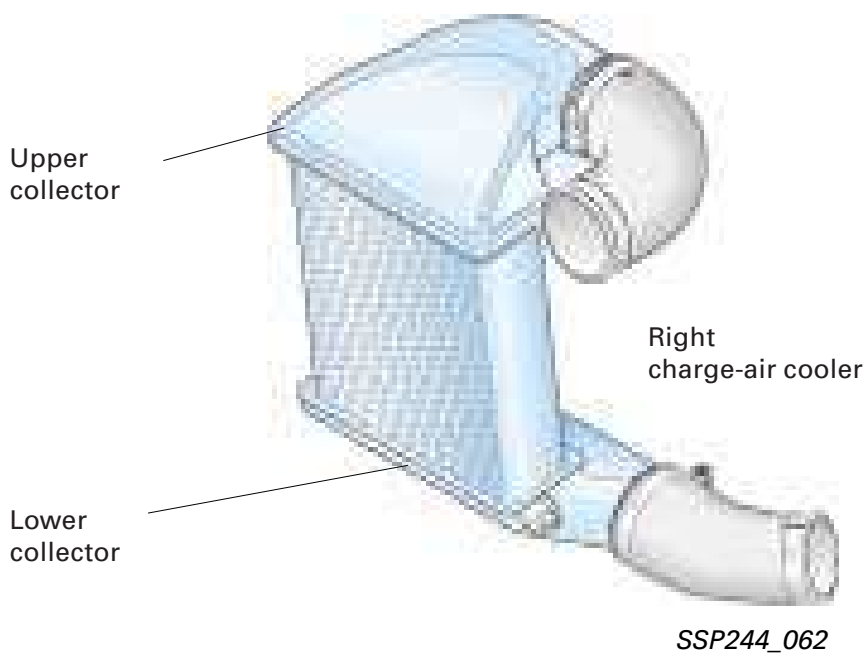
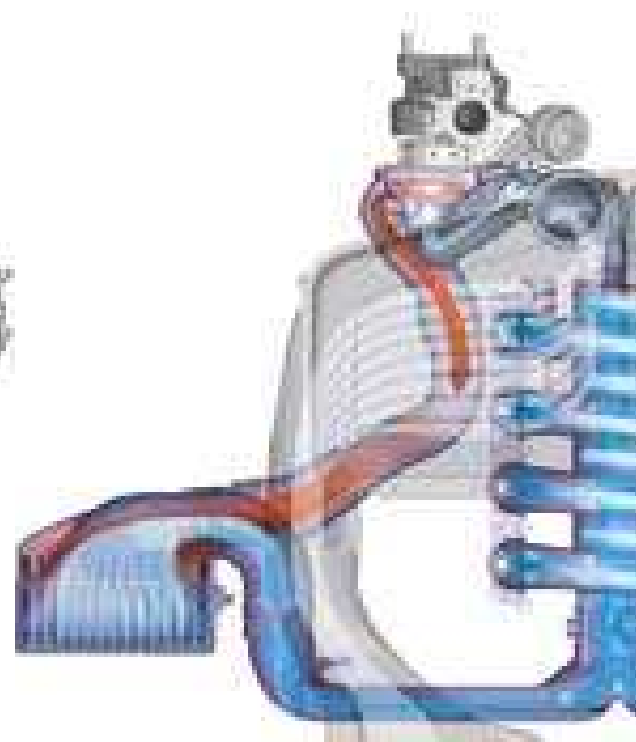
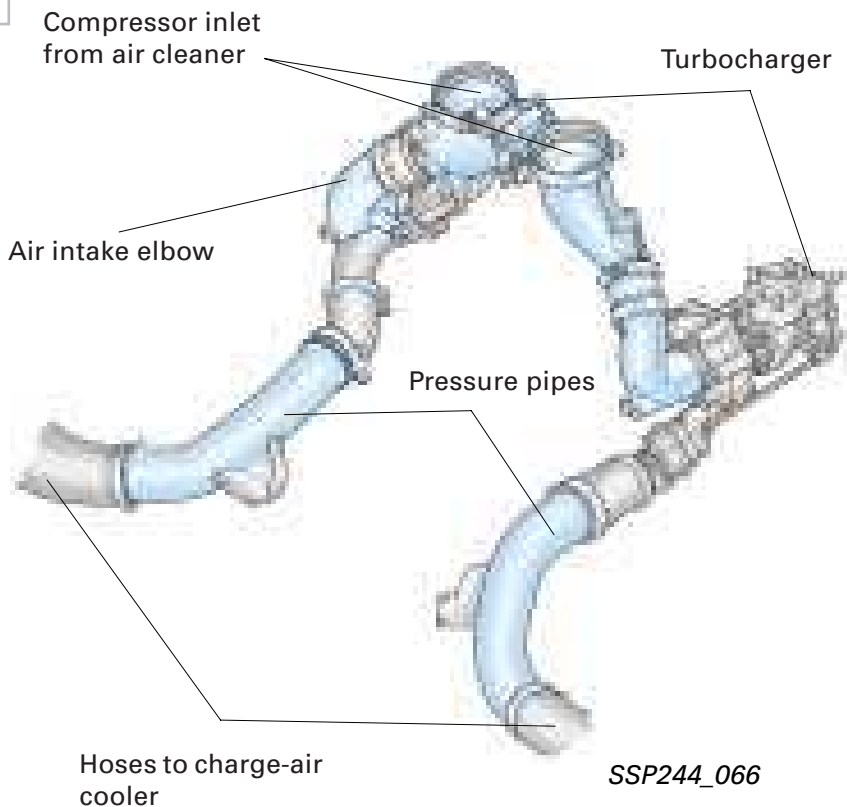

From charge-air cooler



Advantages of charge-air cooling:

- Improved efficiency thanks to greater density of cooled air
- Lower temperatures, reduced knock tendency

After passing through the hot-film air-mass meters, the flow of air is conveyed by way of a piping system to the water-cooled turbochargers. Vibration-damping elements at the air cleaner outlet and pressure pipe connections ensure acoustic

isolation of the entire system. From the turbocharger, the hot compressed air is routed to the charge-air coolers and then through the newly developed air collector pipe at the front of the engine. The intake manifold is responsible for distribution to the cylinders.

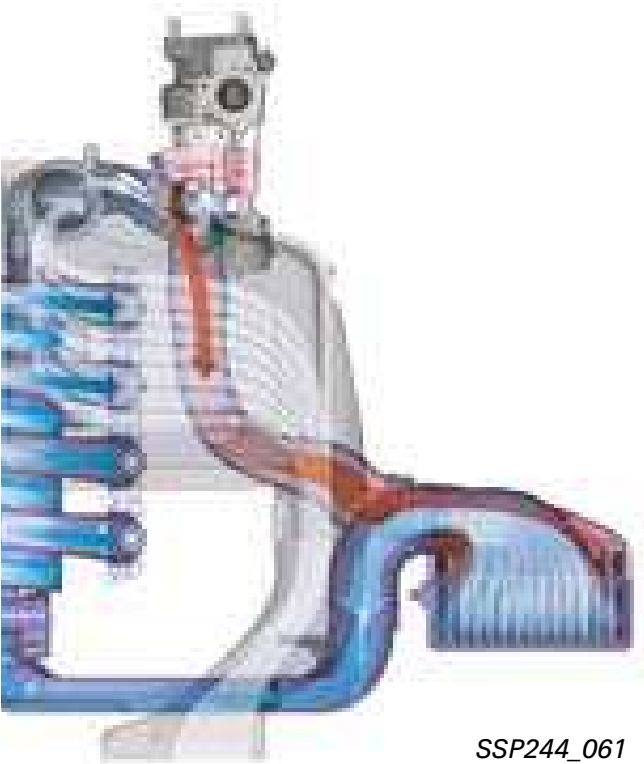
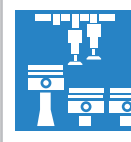

SSP244_061

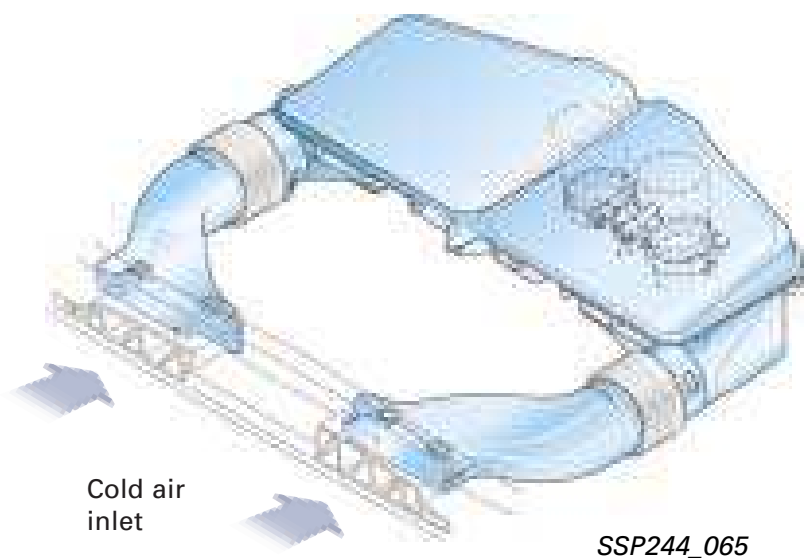

Cold air inlet

SSP244_065

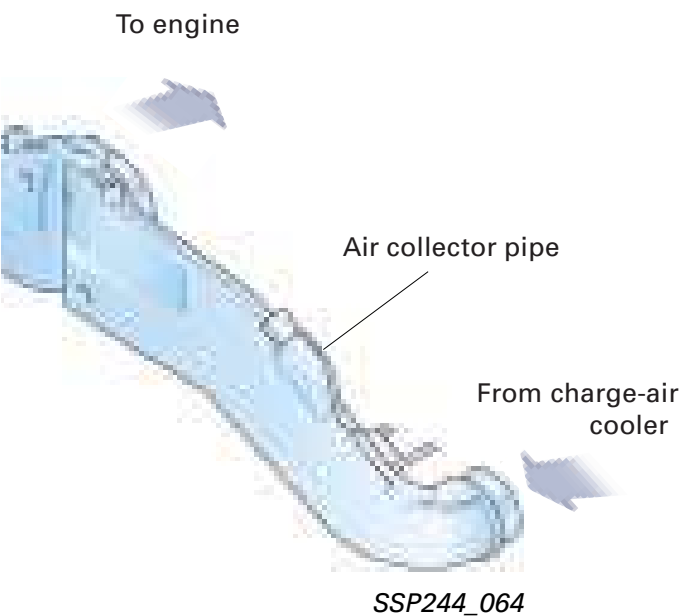

To engine

Air collector pipe

From charge-air cooler

SSP244_064

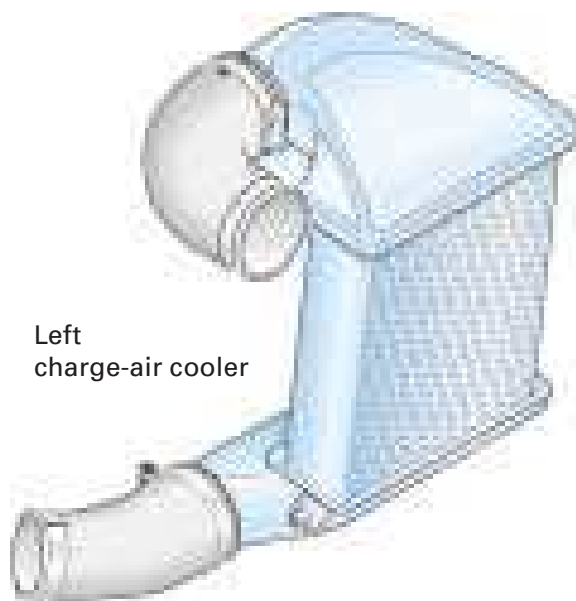

Left charge-air cooler

SSP244_063

Engine and Gearbox

Crankcase breather

The crankcase breather consists of the following:

- Pressure limiting valve
- Non-return valve
- Tubing with distributor

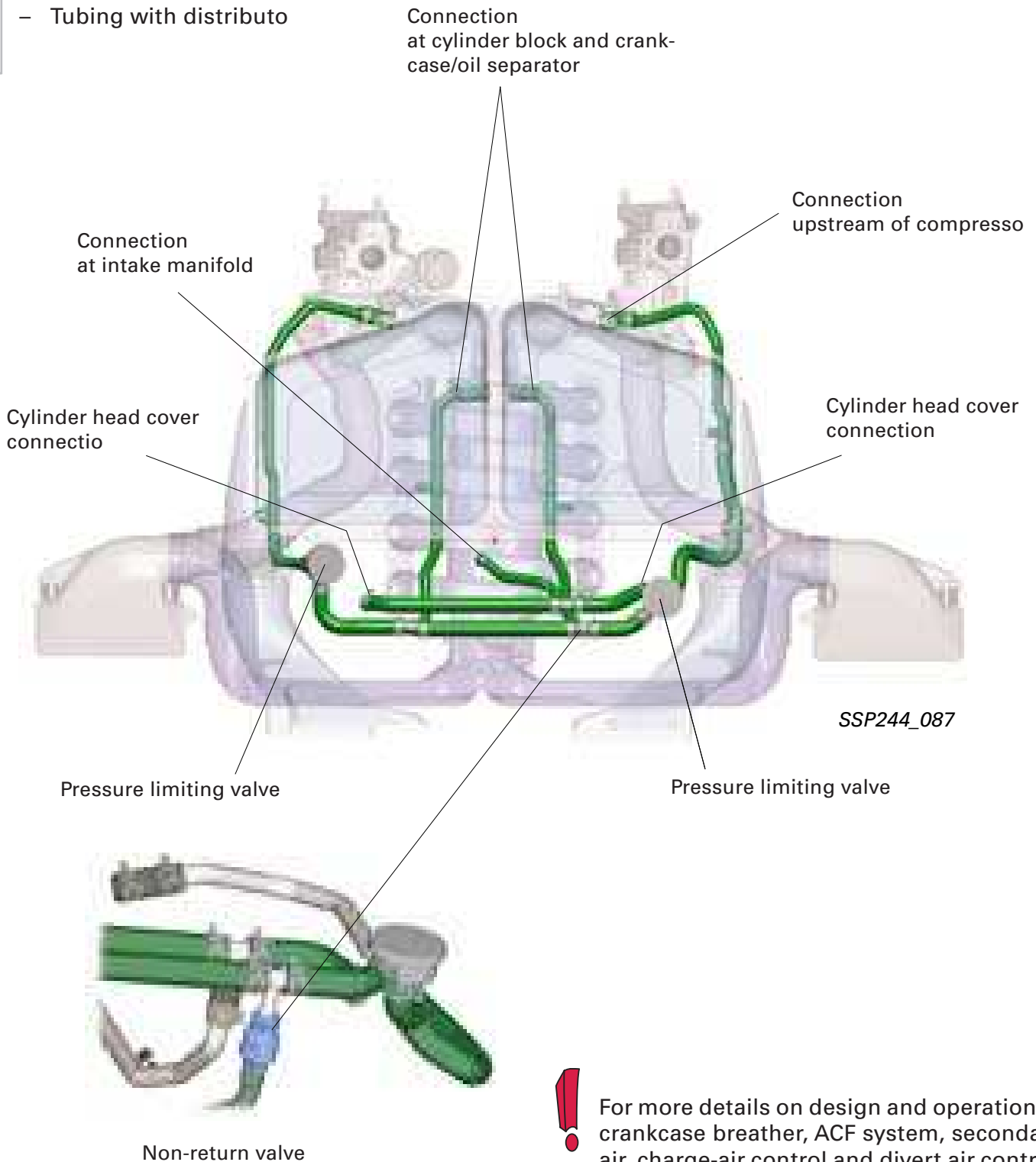
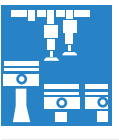

For more details on design and operation of crankcase breather, ACF system, secondary air, charge-air control and divert air control, refer to SSP 198 – The 2.7 I V6 bi-turbo.

ACF system

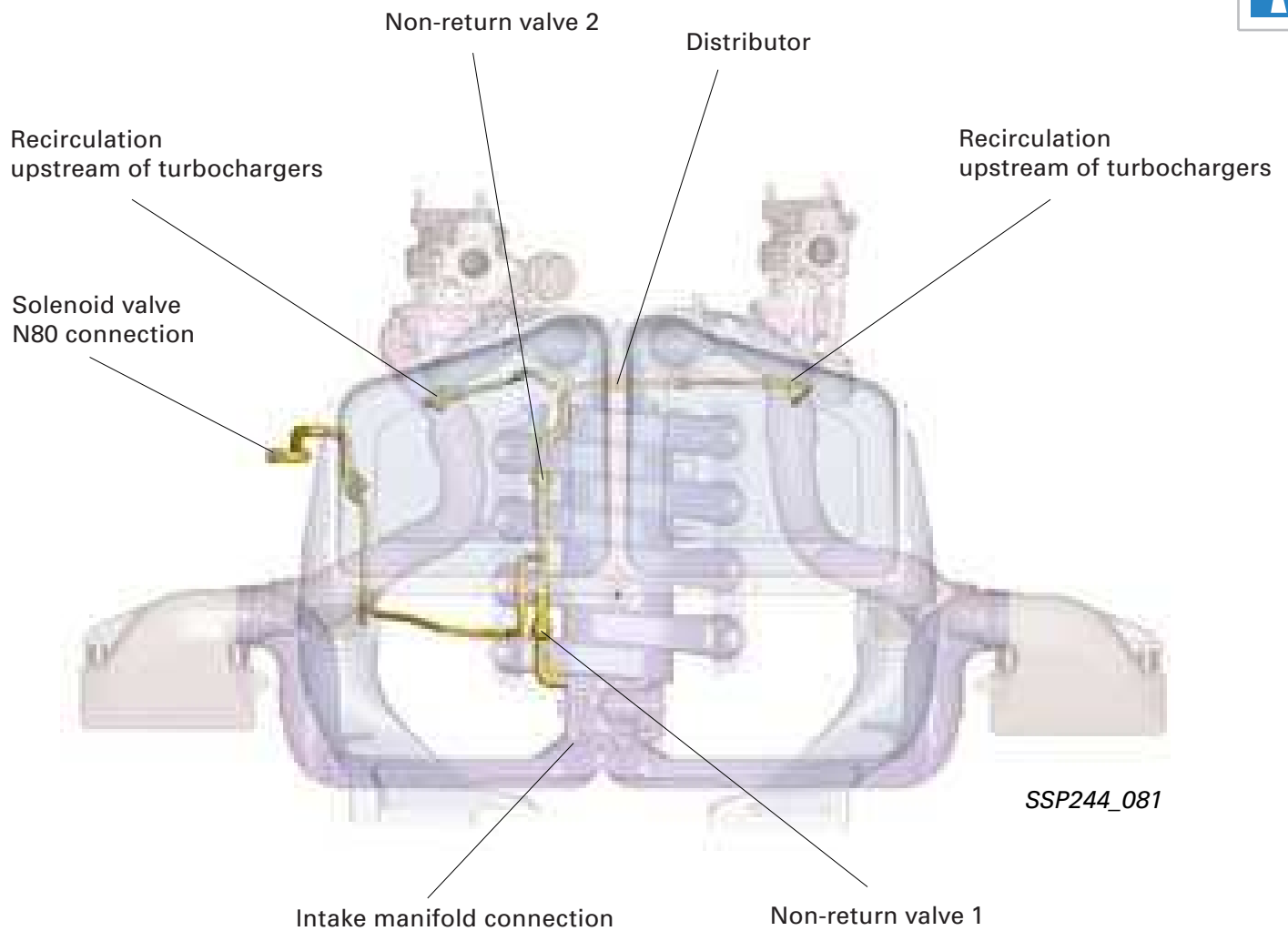

The ACF pipe system recirculates the fuel vapours from the activated charcoal filter via the solenoid valve N80 and two non-return valves to the intake manifold.

The non-return valves regulate the fuel vapour recirculation on the basis of a duty cycle specified by the Motronic to suit the corresponding operating status.

Engine and Gearbox

Secondary-air system

Secondary air combination valve 1

Secondary air combination valve 2



Charge-pressure control

Charge-pressure control solenoid valve N75

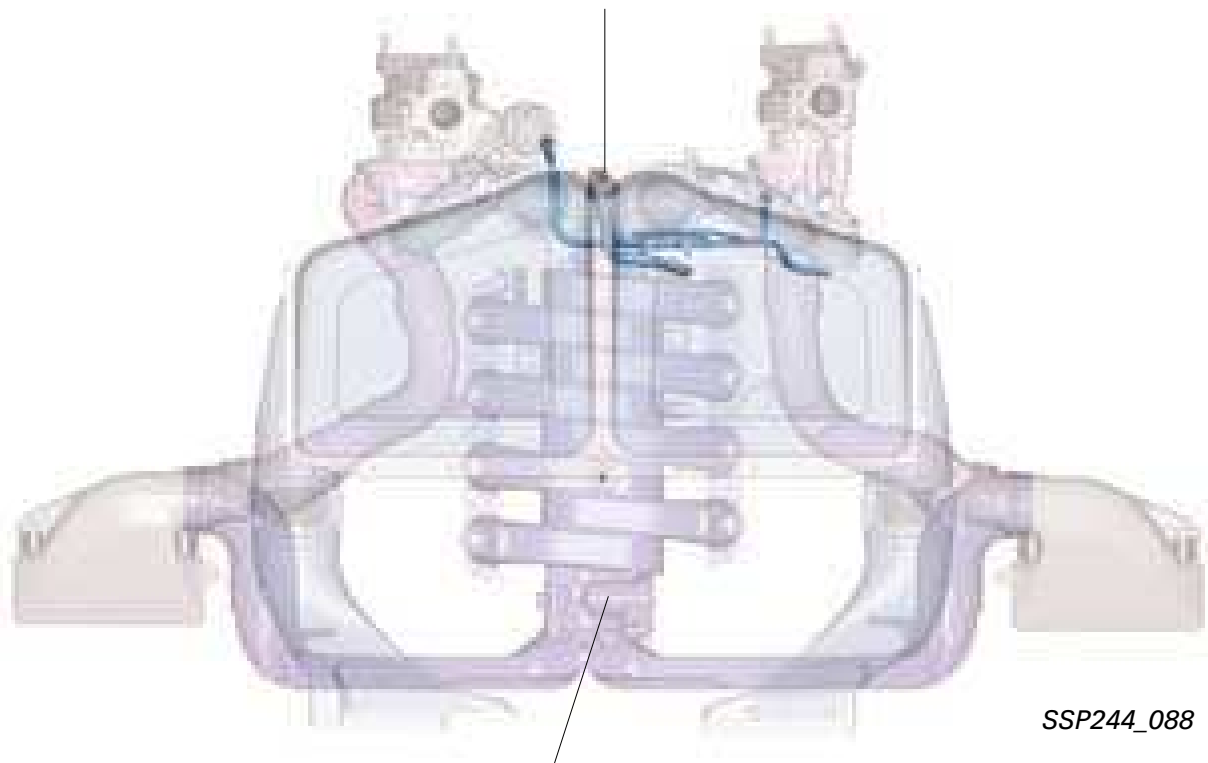

Divert air control

The sudden transition from operation under load to overrun produces a high back pressure between turbocharger and throttle valve. To protect the turbochargers, this pressure is dissipated by opening the divert air valves. At the same time, this also reduces the drop in turbocharger speed and enhances re-operation response.

The pneumatic divert air valves are actuated by the Motronic via the solenoid turbocharger divert air valve N249. By incorporating the vacuum reservoir, the divert air valves can operate independently of the intake manifold.



Vacuum reservoirs for controlling divert air valves are located in front left wheel housing

Re-entry of diverted charge air upstream of turbocharger

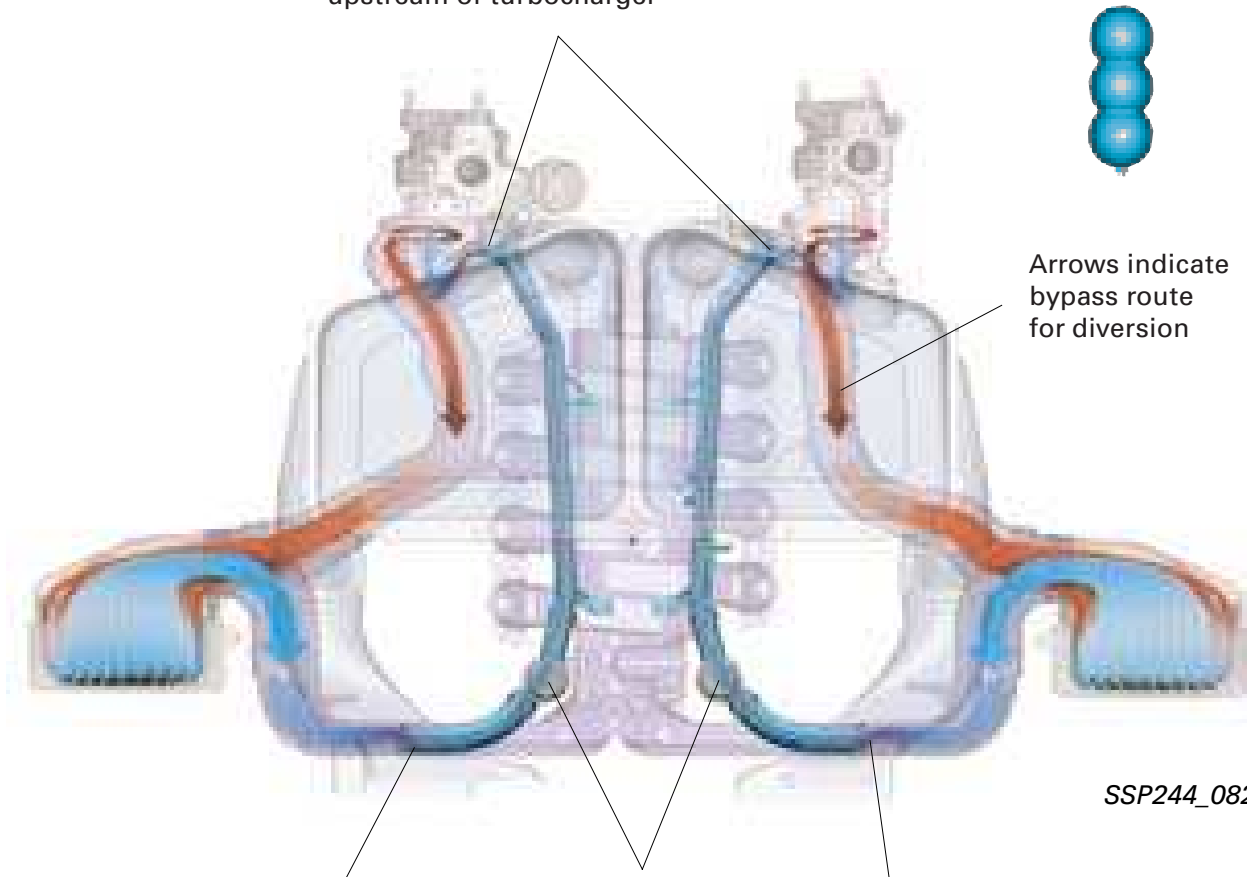

Arrows indicate bypass route for diversion

SSP244_082

Connection at air collector pipe

Pneumatic divert air valves

Connection at air collector pipe



In the event of solenoid turbocharger divert air valve N249 failure, the intake manifold pressure keeps the pneumatic divert air valves open.

Engine and Gearbox

Cooling system

The combined engine and gear oil cooler, the fluid cooler, the air conditioner condenser and the radiator are arranged behind one another.

The coolant/oil heat exchanger, an oil cooler without separate housing, is bolted to the oil filter module to form a unit.

An additional oil/air heat exchanger is required on account of the high level of power transmission in the automatic gearbox. The engine and gear oil cooling functions are combined in a joint cooler. The oil circuits are kept separate.

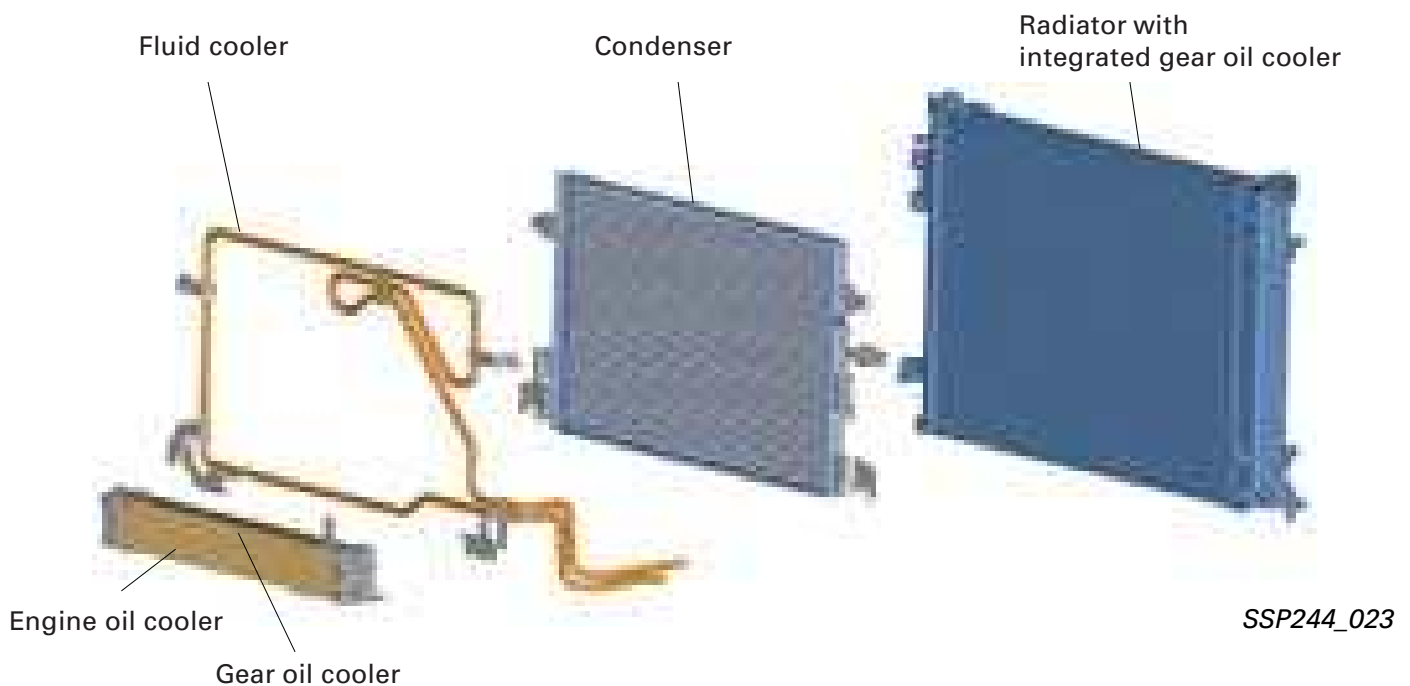
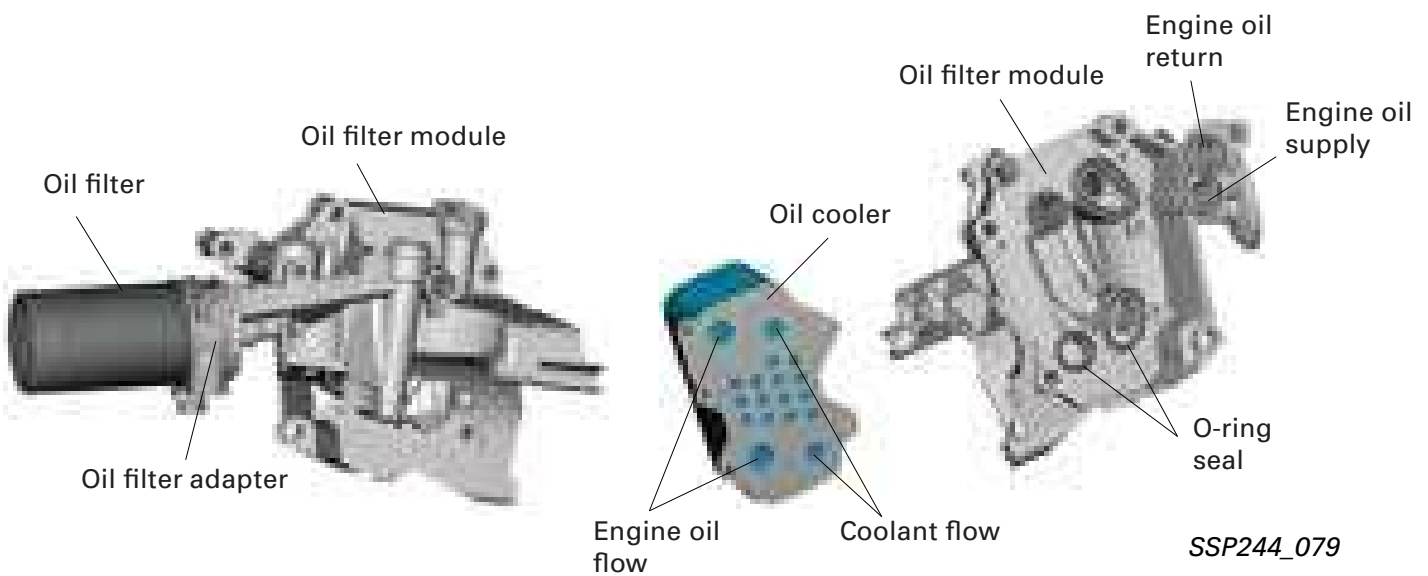

Fans

Two suction fans connected in parallel (600 and 300 W) are used to provide the cooling air required in the Audi RS 6. The fan control units are actuated by way of the engine control unit as a function of load.

The control unit for the 600 W fan is integrated directly into the fan motor, whereas the 300 W fan has an upstream control unit/output stage. Different conditions apply to actuation of the two fans.

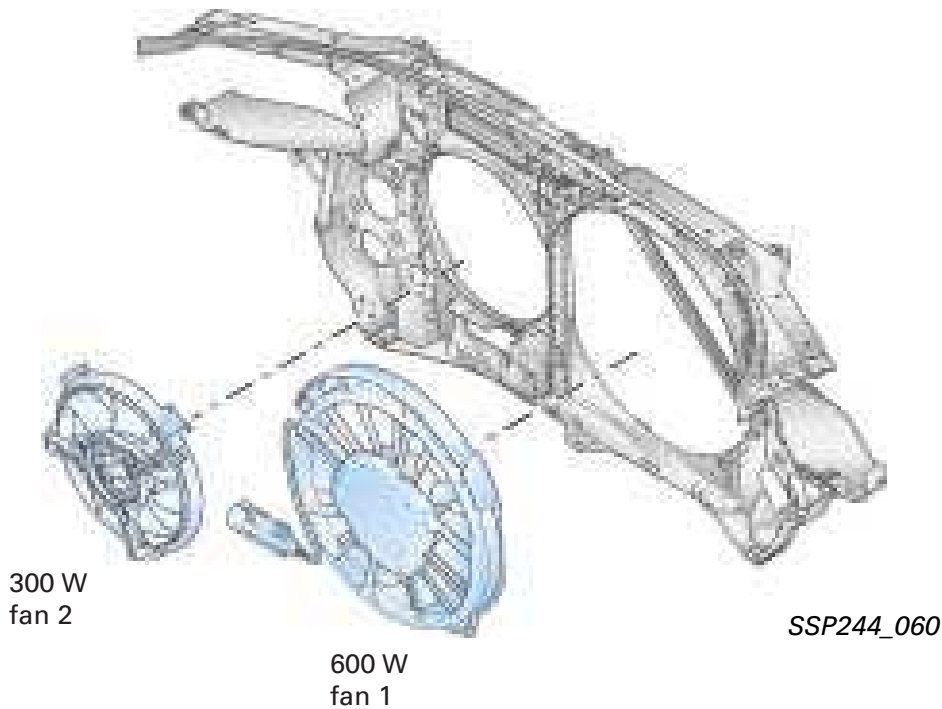

1. Fan request is transmitted by air conditioner operating unit via CAN bus to engine control unit and relayed from there directly to fans.
2. In normal engine operation or at idle the fans are controlled as a function of engine and ambient temperature. Maximum selection is made between air conditioner and engine temperature.
3. Triggering and duration of fan run-on after switching off engine are governed by three different criteria:
 - Average fuel consumption > 7 ml/s and engine temperature > 105 °C when engine is switched off
 - Measured engine temperature greater than 105 °C and ambient temperature greater than 0 °C
 - On switching off engine, oil temperature greater than 110 °C

! If the fan control units do not receive any information from the engine control unit, the fans switch to emergency operation and this is recorded in the fault memory.

! Checking fan operation with the engine running cannot give an absolute guarantee that the fans will also respond in run-on mode. A separate check must always be made following repairs.



Engine and Gearbox

Coolant circuit

Continued coolant circulation pump

The coolant pump in the Audi RS 6 circuit conveys the coolant to the cylinder banks, where it is evenly distributed and flows through both banks.

The engine oil cooler is also integrated into the water circuit.

Use is made of an electric water pump to avoid reheating.

After switching off the engine, local overheating (vapour bubble formation) may occur due to reheating of the coolant in the area of the turbochargers.

To prevent this, continued circulation is maintained for a certain period by the continued coolant circulation pump V51 via the corresponding relay J151.

The pump is actuated by the Motronic control unit J220 via the continued coolant circulation relay J151.

The cut-in criteria for the continued coolant circulation pump are provided by the following sender values:

- Coolant temperature (G2/G62)
- Engine-oil temperature (G8)
- Ambient temperature (G42)

Coolant circulation during engine operation

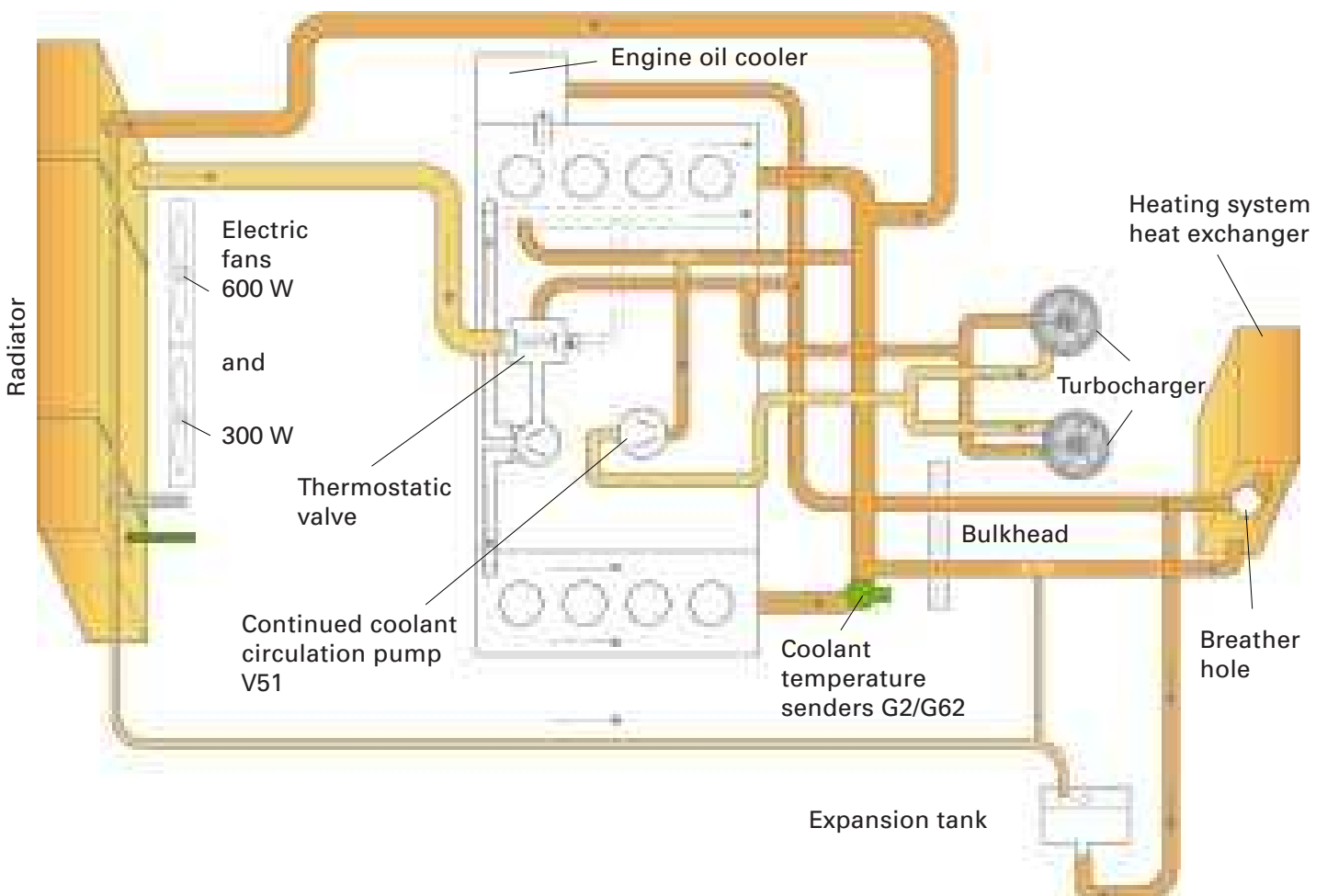

The continued coolant circulation pump is located beneath the intake manifold. Pump operation is not required when the engine is running. The pump is not actuated directly. Actuation of the continued coolant circulation pump reverses the direction of coolant flow to the turbochargers.

At engine temperatures of $> 60\text{ }^{\circ}\text{C}$, pump run-on is maintained for approx. 15 minutes before the main relay is finally deenergised.



The red arrows in the marked frame indicate the change in flow direction.

Coolant circulation during run-on

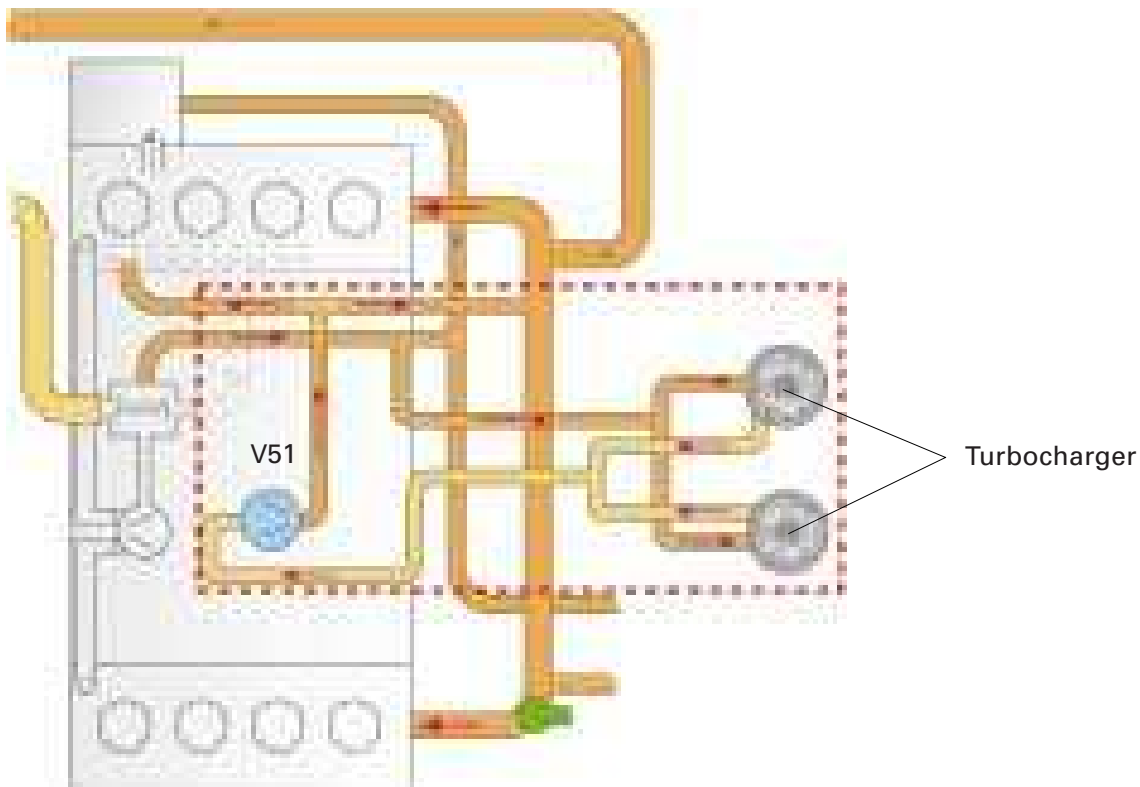

SSP244_085

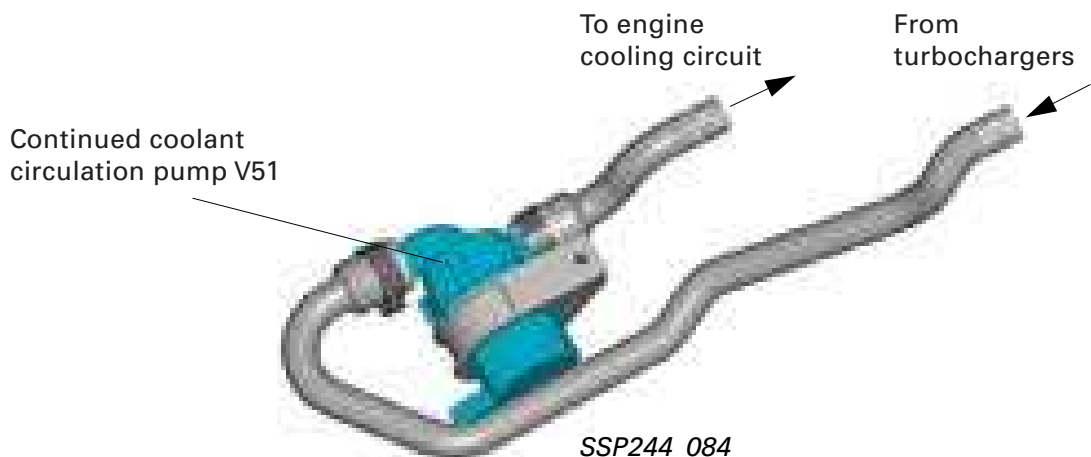

SSP244_084

Engine and Gearbox

Oil cooling

The oil cooling system in the Audi RS 6 is split up into two circuits:

Engine oil cooling

This is implemented by way of a constant flow through the coolant/oil heat exchanger (rapid attainment of engine-oil operating temperature on cold starting by preheating via heat exchanger).

After reaching a specified temperature value, the second circuit to the air-to-oil cooler is switched in on a thermostat-controlled basis.

This is located at the front end beneath the radiator and is fitted in a joint housing together with the additional gear oil cooler. The two have separate inputs, however, and operate independently.

The direction of flow of the oil to be cooled is always the same to prevent thermal stress in the cooler housing.

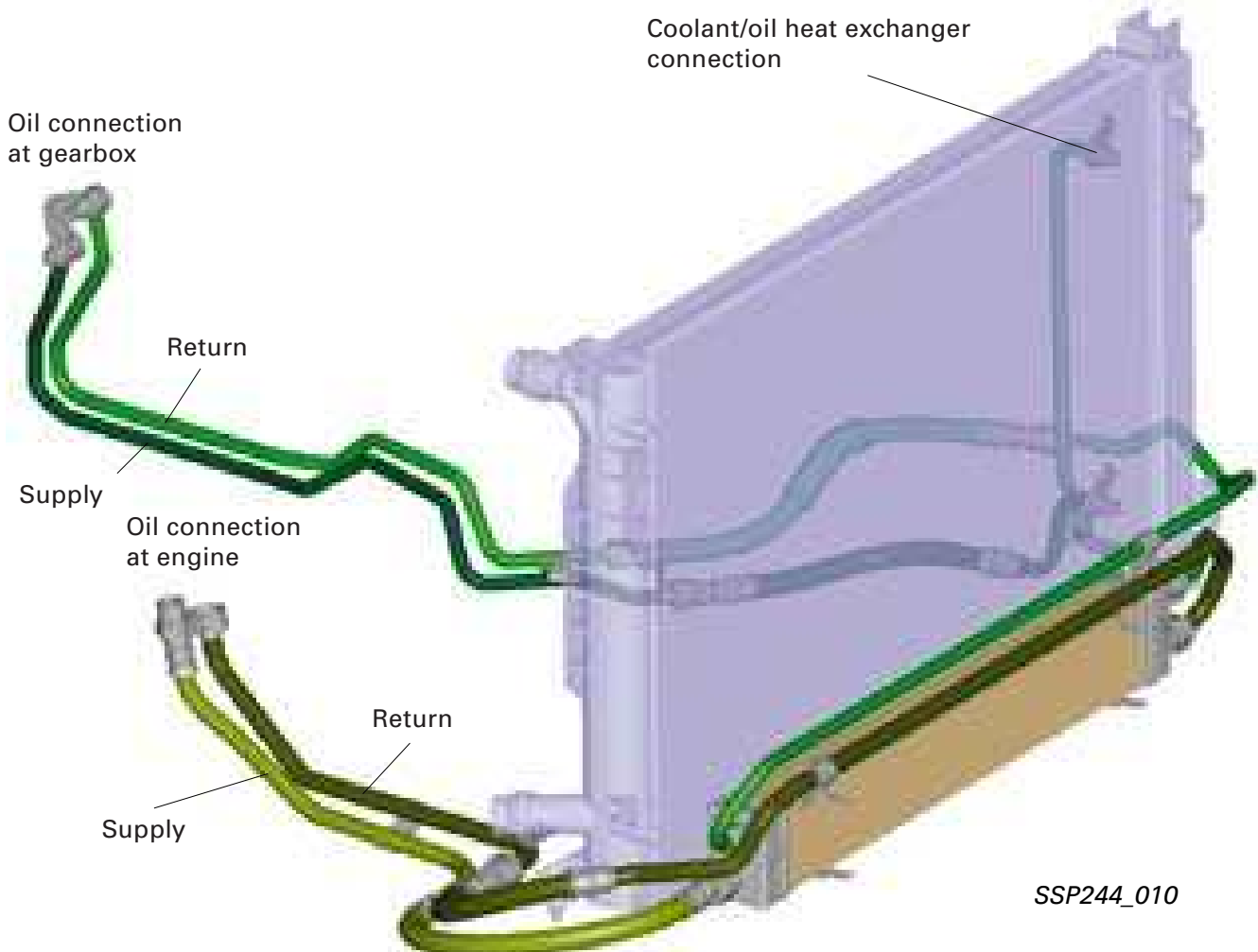

SSP244_010

Gear oil cooling

To ensure a long gearbox service life, use is again made of two coolers:

Water-to-oil cooler

After starting the engine, the oil starts to flow in the area of the water-to-oil cooler.

As the coolant in the water circuit warms up more quickly, the gear oil thus also attains its operating temperature sooner.

Air-to-oil cooler

The air-to-oil cooler additionally fitted in the circuit maintains the temperature at an optimum level when increased power is required.



Extremely low ambient temperatures could cause gearbox problems if the gear oil were not to be preheated.

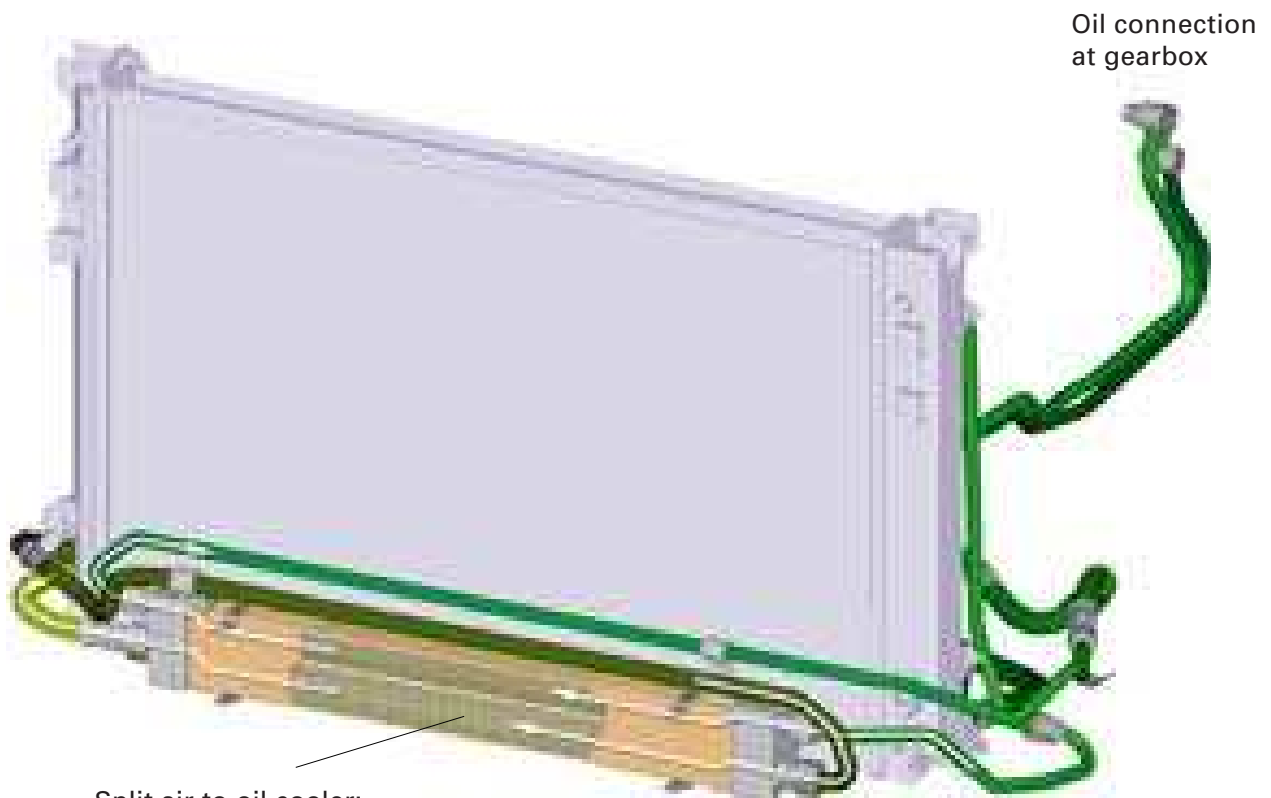

Split air-to-oil cooler:
1/3 gear oil cooling (top)
2/3 engine oil cooling (bottom)

SSP244_068

Engine and Gearbox

Fuel system

The Audi RS 6 features two fuel pumps with hydraulic series connection to provide the necessary fuel:

Fuel pump 1 G6 is located directly in the tank.

Fuel pump 2 G23 is fitted to the tank as an external pump unit.

Both pumps are electrically actuated in parallel by way of the fuel pump control unit J538, which is fitted next to the rear right seat belt reel beneath a cover. This control unit is supplied with electrical system voltage by way of the fuel pump relay J17.

The Motronic control unit J220 is responsible for cut-in of the two pumps as required via the fuel pump control unit J538.

Depending on the instantaneous fuel requirement, the pumps are actuated either with maximum electrical system voltage (high requirement) or with voltage reduced to 10 V (lower requirement).

The corresponding switching control signal is derived from the instantaneous fuel consumption calculated in the engine control unit.

In the event of a change in the volume of fuel required, the fuel pump control unit switches the pump voltage from maximum electrical system voltage to 10 V and vice versa. The voltage reduced to 10 V is provided by a voltage converter in the fuel pump control unit.



SSP244_027

Fuel tank with external auxiliary fuel pump

On starting the vehicle, the fuel pumps are actuated for roughly 1 second with maximum electrical system voltage. This ensures a rapid build-up of pressure in the fuel supply (provision of standby pressure).

When driving, the pump voltages are switched in line with fuel consumption. On dropping below a defined fuel consumption rate the pump voltage is reduced to 10 V after a delay of approx. 2 seconds.

In the case of "hot starting", the pump voltage remains at electrical system voltage level for roughly 5 seconds after starting to stop vapour bubbles forming in the fuel pipe.

A conventional fuel pressure regulator at the fuel rail keeps the fuel pressure at a constant 4 bar relative to intake manifold pressure.

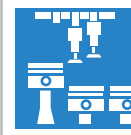

! If a fault is detected, it is either no longer possible to start the engine or it switches to emergency operation.

Fuel pump unit with increased delivery

Fuel filter



Fuel pump 2 G23

SSP244_014

Engine and Gearbox

Fuel pump electrical circuit

Control wire A voltage	Pump operating voltage
0 V	10 V
12 V	12 V

A (blue)
Control signal

B (green)
Feedback (pump status)
from pump control unit
to engine control unit

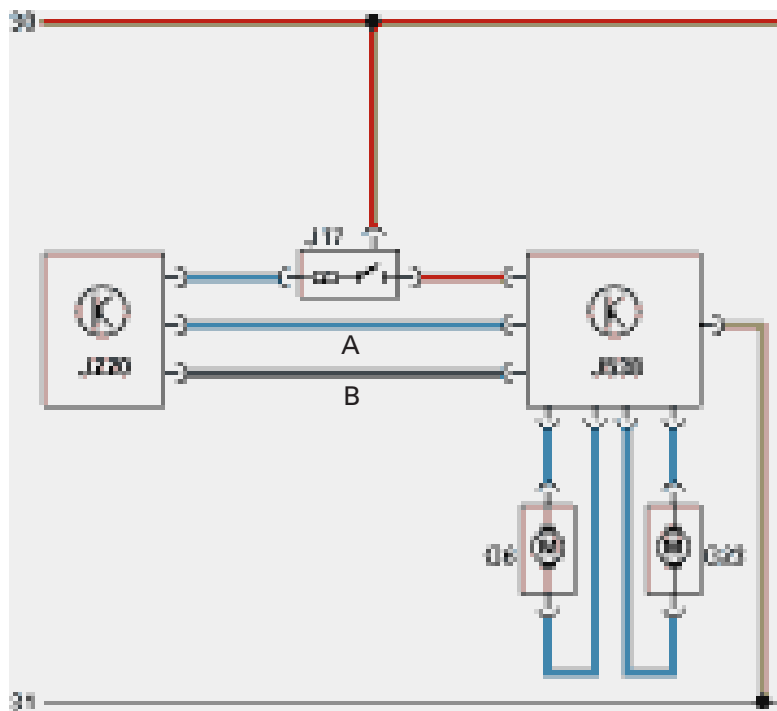

SSP244_077

- G6 Fuel pump (pre-supply pump)
- G23 Fuel pump
- J17 Fuel pump relay
- J220 Motronic control unit
- J538 Fuel pump control unit

Control unit
for fuel pump



SSP244_029

Diagnosis

The engine control unit monitors the connections to the fuel pump control unit for short circuit; the fuel pump control unit monitors the connections to the pumps for short circuit and at the same time transmits the output voltage values to the engine control unit. These values are monitored for plausibility.

Following entry of a fault in the fault memory, it is either no longer possible to start the vehicle (fuel pump relay does not switch) or the engine will only run in emergency mode.

Exhaust system

The Audi RS 6 has a dual-flow exhaust system. The two exhaust pipes of the V8 engine are routed separately from the engine to the two oval tailpipes and produce the typical RS 6 sound.

The exhaust gas is conveyed in individual pipes from the cylinders via the air-gap insulated manifolds directly downstream of the turbochargers to two under-bonnet primary catalytic converters of the metal substrate type.

Further downstream, two isolating elements provide the necessary vibration compensation (and acoustic isolation) as well as compensating for engine movement with respect to the exhaust system.

The following underfloor catalytic converters (again of metal substrate type) achieve optimum emission control with low exhaust gas back pressure.

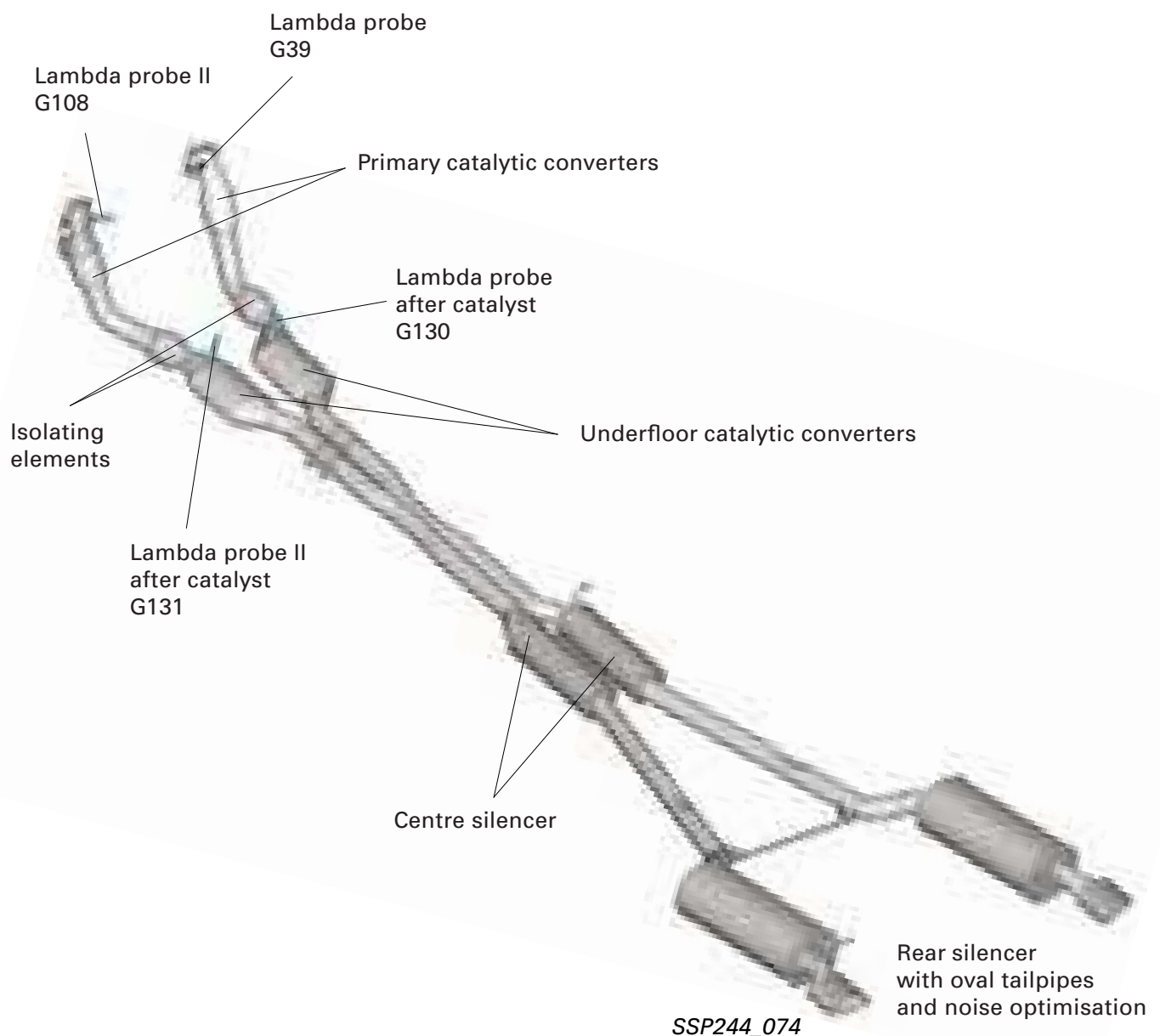
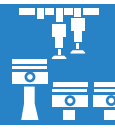

Engine and Gearbox

Turbochargers

Charging is provided by two water-cooled, rapid response, mechanically controlled turbochargers.

Charge-pressure control is implemented by way of the common charge-pressure control solenoid valve N75.



New stud and nut method of exhaust manifold attachment to turbocharger



The turbochargers are not to be replaced separately but only as a pair to avoid differences in performance on account of structural tolerances (old/new component).

Gearbox

The engine torque is transmitted to the gearbox by way of a hydrodynamic torque converter (diameter 280 mm) with lock-up clutch.

The gearbox is based on a proven design for vehicles with high engine torque, employing tiptronic® and electronic throttle.

It takes the form of an electrohydraulically controlled 5-speed automatic gearbox (from the Audi A8 W12) with a transmission capacity of 560 Nm and 331 kW (450 hp).

The 5 forward gears and the reverse gear are implemented by way of a planetary gearbox.

Clutch, selector elements and brakes are controlled electrohydraulically and permit gear selection under load with no loss of tractive power.

The following modifications have been made with respect to the previous gearbox:

- Reinforced transfer gear and gearbox housings
- Increased clutch pressure
- Brake "D" reinforced (one additional coated disk)
- Reinforced spur gear drive splines (modified material)

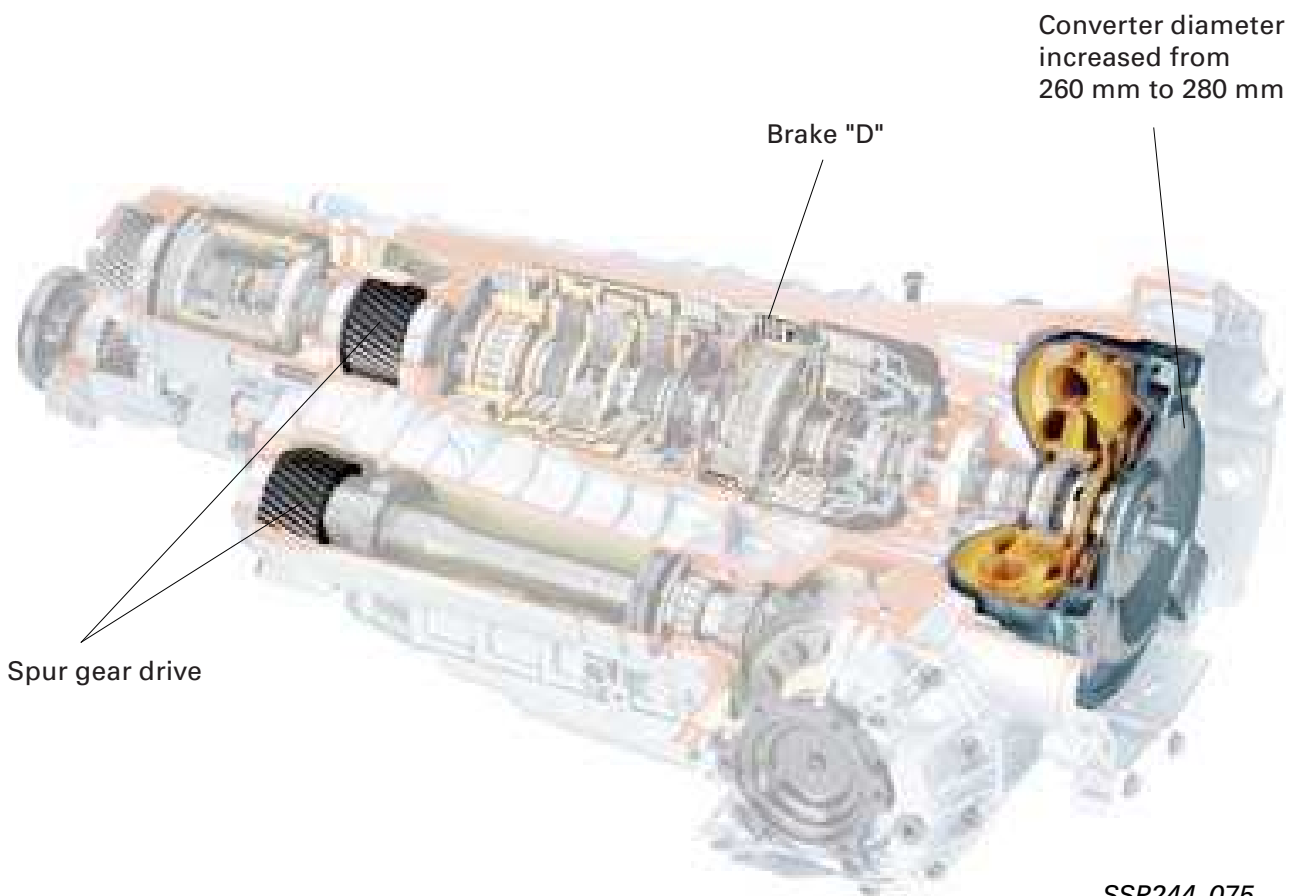

SSP244_075



Engine and Gearbox



The gearbox flange of the crankcase has been reinforced at the mounts. Modified gearbox mounts are required to accommodate the forces occurring.

Three bolts are used on either side of the gearbox housing for mounting.

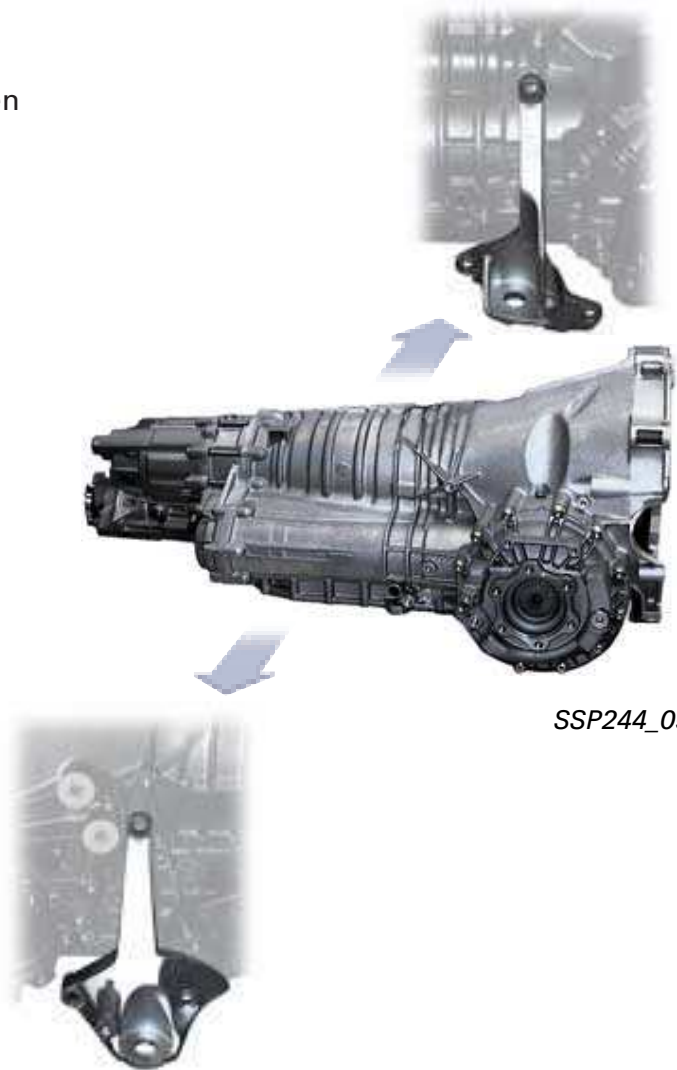

SSP244_055

Rear final drive

On account of the thermal load resulting from the drive power, the rear-axle transfer case is provided with an additional aluminium cooling fin element.

A special thermal conduction paste between the housing and the fins of the aluminium heat sink ensures optimum heat dissipation.



Rear final drive with top-mounted aluminium cooling fin element

SSP244_041

3-spoke sports steering wheel



Steering wheel with tiptronic® paddles

SSP244_032

Paddles on the right and left of the sports steering wheel permit manual selection of the desired gears. The selector buttons can only be activated in selector lever position D or S or with the manual tiptronic® program.

Change-up – tap right paddle (+)
towards steering wheel

Change-down – tap left paddle (-)
towards steering wheel



In selector lever position D/S, the gear-box control returns to the selected automatic mode if the paddles are not actuated for approx. 30 seconds.

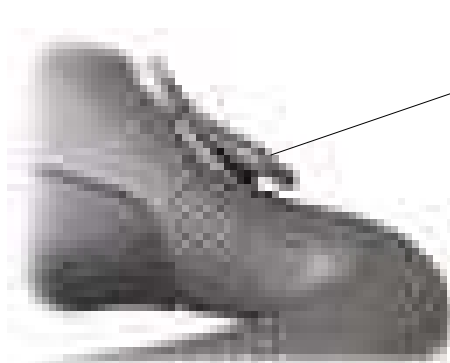

SSP244_037

Paddle



SSP244_036



Engine and Gearbox

System layout

Motronic ME7.1.1 Sensors/actuators

Hot-film air-mass meter G70,
hot-film air-mass meter 2 G246

Engine speed sender G28

Hall sender G40 and Hall sender 2 G163

Lambda probe G39 and Lambda probe II G108
Lambda probe after catalyst G130 and
Lambda probe II after catalyst G131

Throttle valve control part J338
with angle sender (1) G187 and (2) G188 for
throttle valve drive G186

Intake-air temperature sender G42

Coolant temperature senders G2 and G62

Charge-air pressure sender G31

Knock sensor I G61, knock sensor II G66
and knock sensor III G198

Accelerator pedal position
senders G79 and G185

Exhaust gas temperature senders 1
G235 and 2 G236

Brake light switch F and cruise
control system brake pedal switch F47

Additional signals

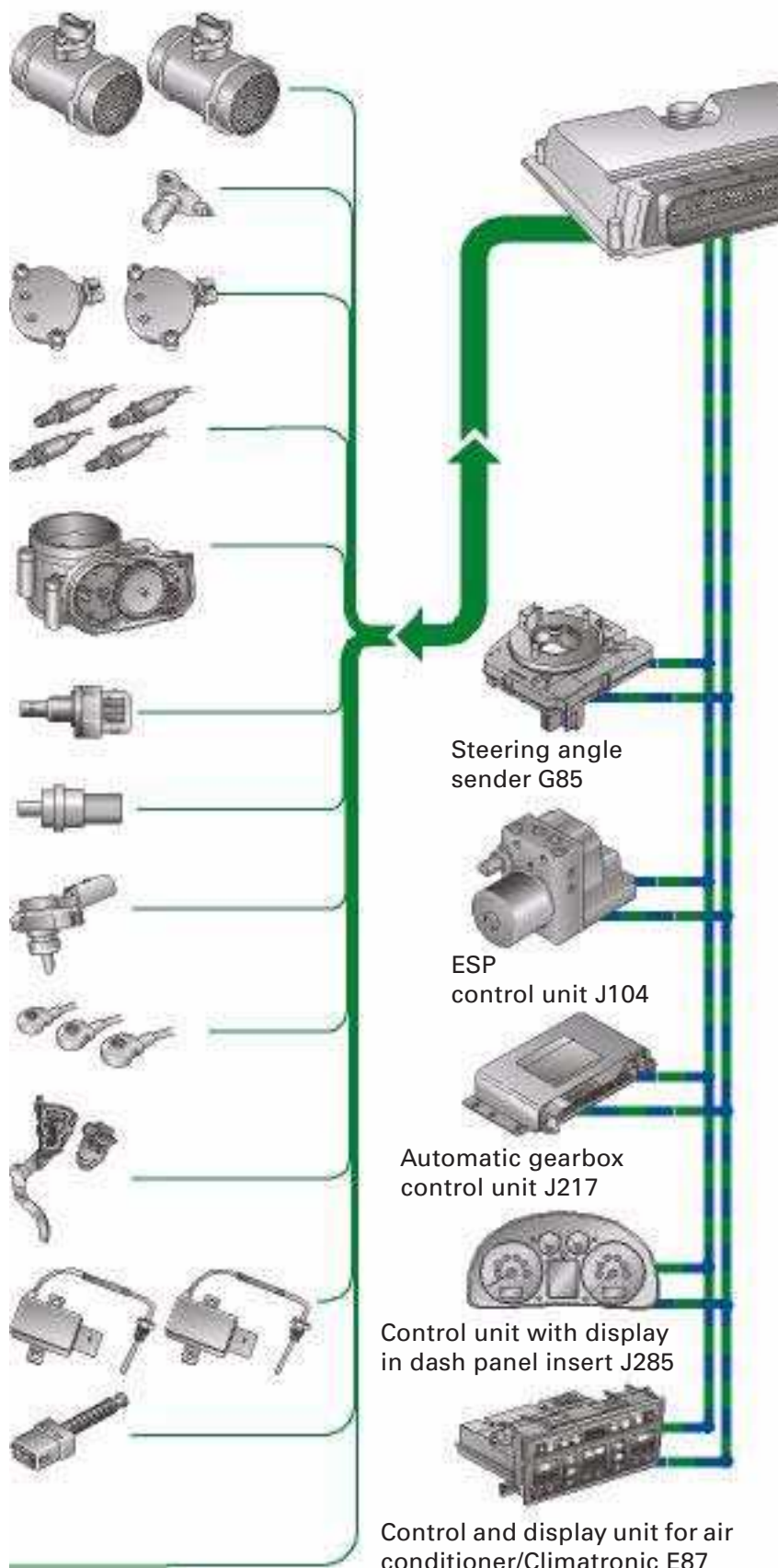

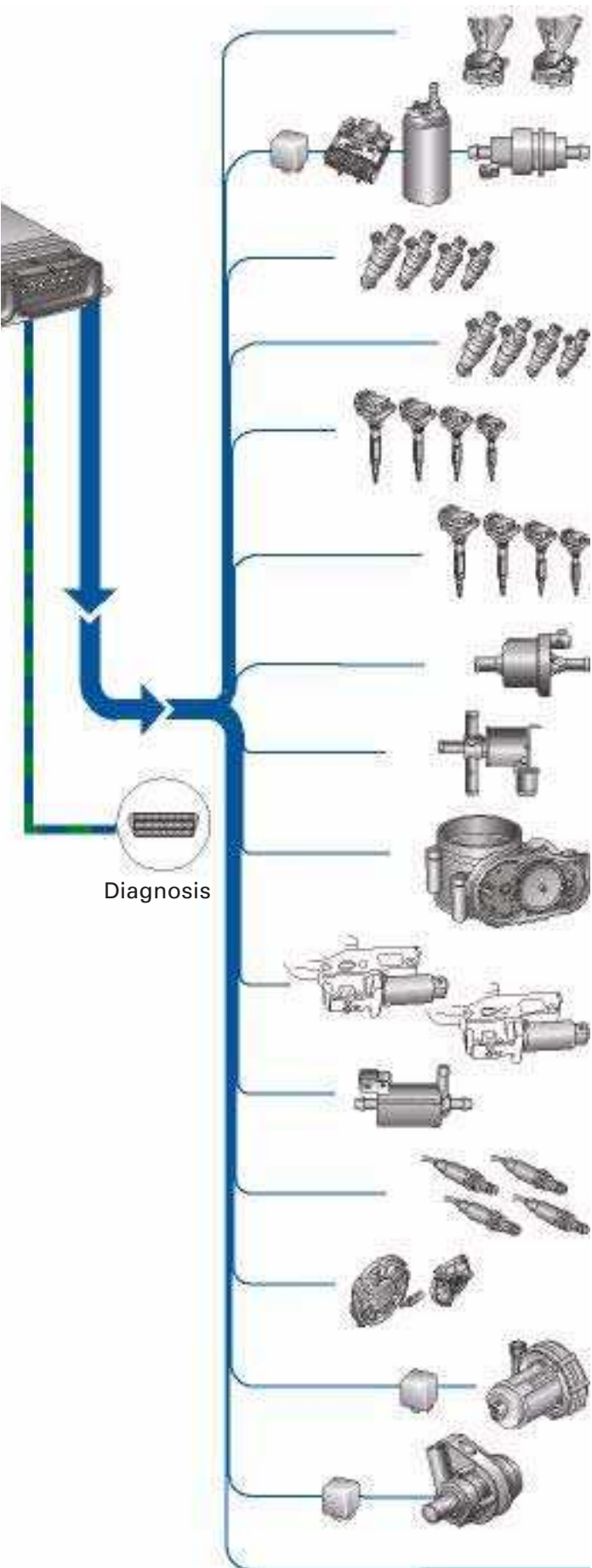

Left/right electrohydraulic engine mounting solenoid valve N144/N145

Fuel pump relay J17, fuel pump control unit J538, fuel pump G6, fuel pump G23

Injectors (bank 1) N30, N31, N32, N33

Injectors (bank 2) N83, N84, N85, N86

Ignition coil with output stage N70 (1), N127 (2), N291 (3) and N292 (4)

Ignition coil with output stage N323 (5), N324 (6) N325 (7) and N326 (8)

Activated charcoal filter system solenoid valve I N80

Charge-pressure control solenoid valve N75

Throttle valve control part J338 with throttle valve drive G186 and throttle valve drive angle senders 1 G187 and 2 G188

Timing adjustment valves 1 N205 and 2 N208

Turbocharger divert air valve N249

Lambda probe heater Z19 and Lambda probe 2 heater Z28, Lambda probe 1/2 heater after catalyst Z29/Z30

Radiator fan control unit J293 and radiator fan control unit 2 J671
Radiator fan V7 and radiator fan 2 V177

Secondary-air pump relay J299, secondary-air pump motor V101

Continued coolant circulation relay J151, continued coolant circulation pump V51

Additional signals

Engine and Gearbox

CAN data exchange

As with the Audi A6, data are exchanged in the Audi RS 6 between the engine control unit and the other control units by way of the CAN bus.

The system layout illustrates the exchange of data between the individual interlinked vehicle systems.



Engine control unit

- Idling speed information
- Accelerator pedal position
- Kickdown switch
- ACTUAL engine torques
- Engine speed
- Driver input torque
- Coolant temperature
- Brake light switch

Gearbox control unit

- Gearshift active/not active
- AC compressor operation not permitted (shutoff)
- Torque converter clutch status
- Selector lever position
- Specified idling speed increase
- Gear information (actual/target gear)
- Motion resistance index (hill detection)
- Emergency programs (information via self-diagnosis)
- Converter loss moment (gearbox mount moment)
- SPECIFIED engine torque
- Idle regulation adaption release
- Engine torque gradient limitation (converter/gearbox protection)

ESP/ABS control unit

- TCS request (TCS = traction control system)
- SPECIFIED TCS intervention torque
- Overrun torque limiting function request
- Overrun torque limiting function intervention torque
- Brake pedal status
- TCS/EBC warning lamp info (EBC = Engine braking control)
- ABS braking active/not active
- EBPD intervention active/not active (EBPD = electronic brake pressure distribution)
- Vehicle speed
- Wheel speeds

- Fault statuses of various messages
- AC compressor operation not permitted (shutoff)
- Vehicle speed
- Idling speed
- CCS switch positions (Cruise control system)
- CCS specified speed
- Throttle valve angle
- Immobilizer
- Temperature in intake manifold
- Electronic throttle warning lamp info
- OBD II warning lamp info
- Fuel consumption
- Actual radiator fan actuation status
- Altitude information
- Pressure upstream of throttle valve (charge pressure)
- Emergency programs (information via self-diagnosis)
- Engine data for maintenance interval extension
- Oil level threshold for oil MIN warning

Drive system CAN High

Drive system CAN Low

Dash panel insert

- Self-diagnosis information
- Coolant level sensor info
- Overheating lamp info
- Fuel level
- Vehicle speed
- Ambient temperature
- Coolant temperature
- Oil temperature
- Mileage
- Immobilizer

Air conditioner and heater electronics

- Air conditioner requirement
- Heated rear window status
- Air conditioner compressor status
- Air conditioner pressure signal
- Radiator fan request

 Data transmitted by engine control unit

 Data received and evaluated by engine control unit



Running Gear

Front axle

Modifications to front axle:

- New protective plate
- 8-piston brake caliper for 4 pads and RS 6 logo
- Multi-layer brake disc, diameter 365 x 34 mm
- Running direction important

On account of the larger scale of the brake system, the diameter of the brake master cylinder has been increased to 26.99 mm. This involved an increase in the hydraulic transmission ratio from $i = 5.5$ on the Audi S6 to $i = 7$ on the the Audi RS 6.

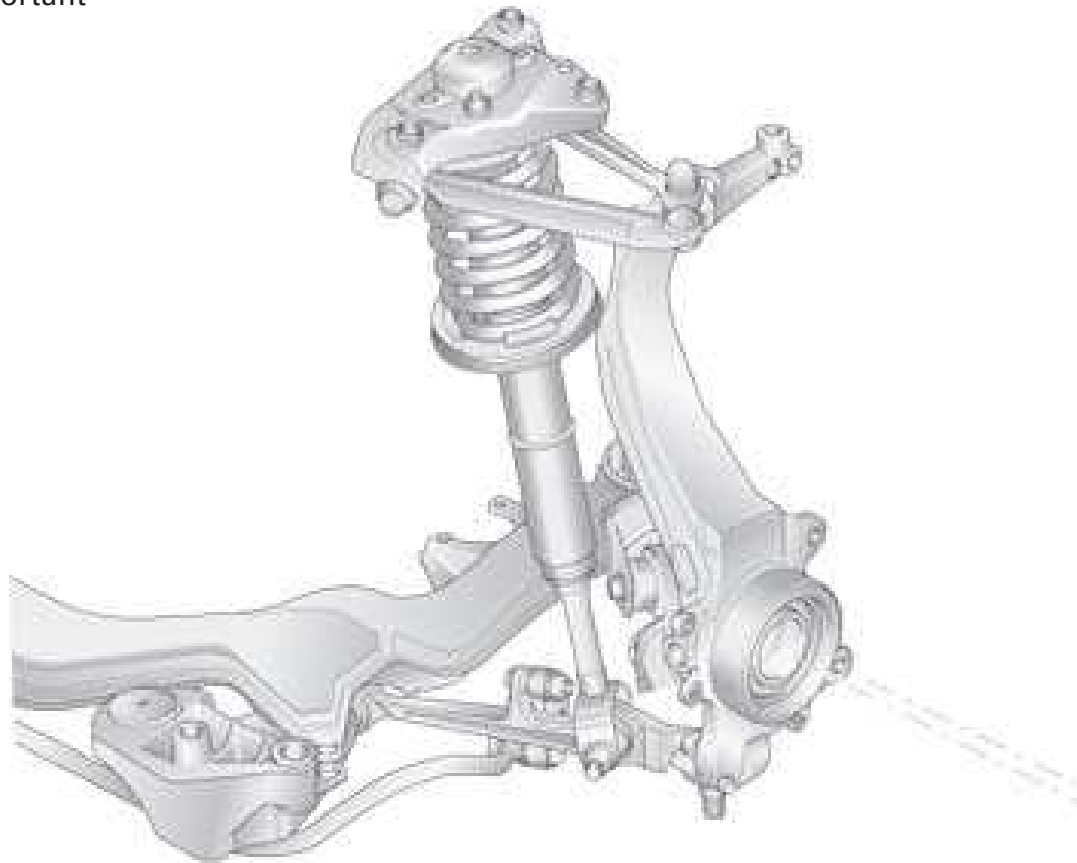

Use was made of a new technology for the wheel bolts in the Audi RS 6 so as to maintain a constant torque.

The tapered section of the bolt is not part of the body of the bolt. Similar to a packing plate, the tapered washer is only loosely attached to the bolt in the cylindrical section.

The particular advantage of this method of attachment is that previously used bolted joints only permit slight changes to the specified tightening torques for aluminium wheels due to contact corrosion.

Coefficient of friction remains constant

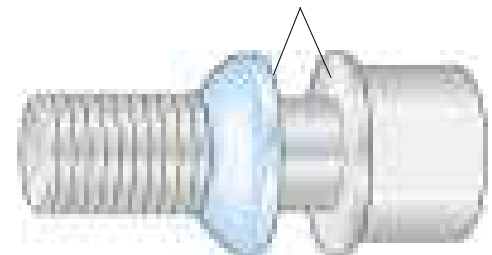

SSP244_017



SSP244_030

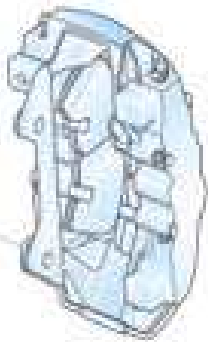

8-piston brake caliper

Wheel hub



Brake disc back plate, adapted to installation conditions

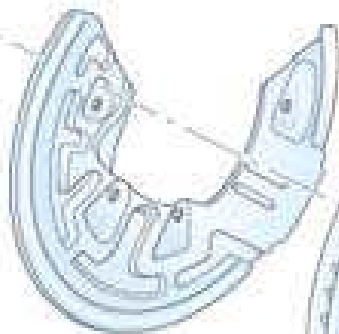

Running direction of disc must always be heeded

Brake disc with a diameter of 365 x 34 mm

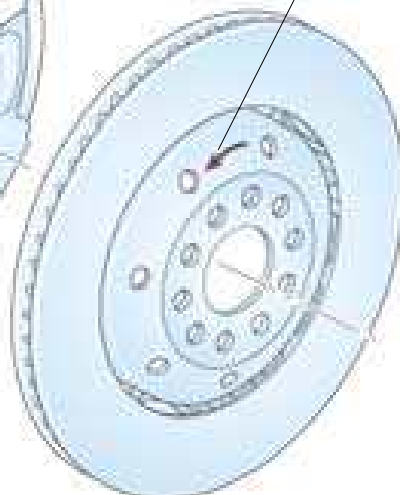

SSP244_012

Running Gear

Rear axle

Use is made of the proven Audi S6 rear axle design.

On account of the increased load, the wheel bearing housings are no longer made of aluminium, but rather of steel.

To achieve the increased braking power, use is also made of rear brake discs with a larger diameter (335 x 22 mm).

The diameter of the single-piston brake calipers has been enlarged.

The handbrake cable had to be lengthened to suit the installation conditions.

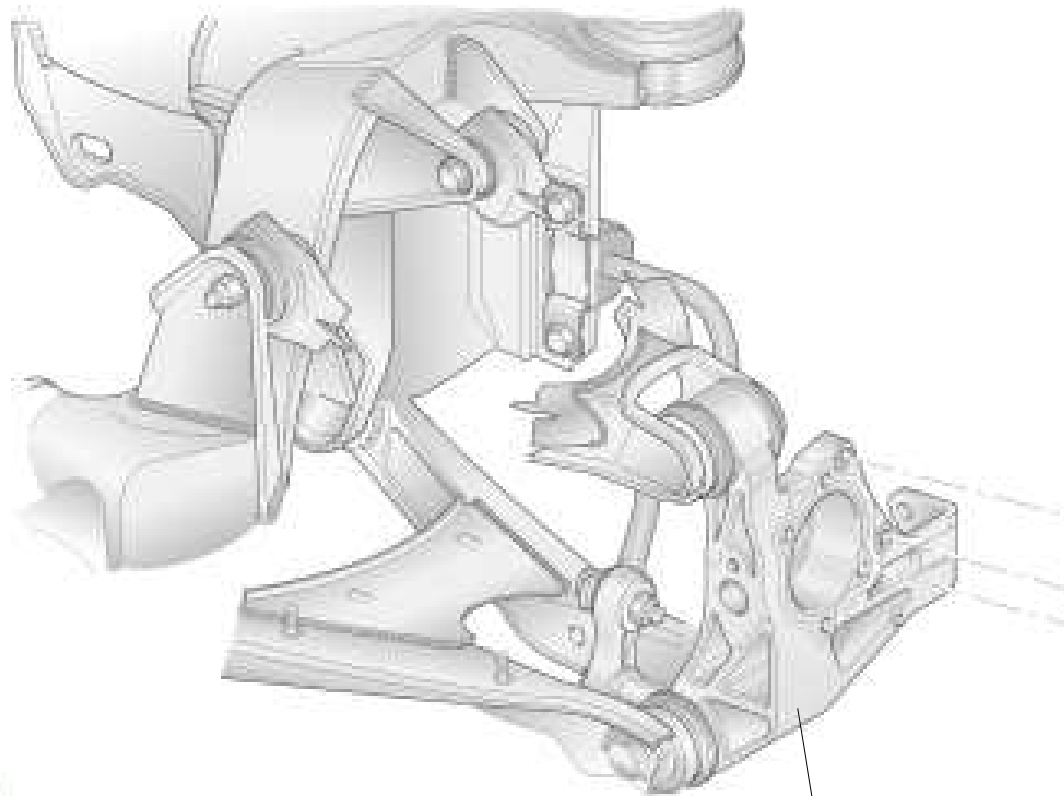

Audi S6 aluminium wheel bearing housing

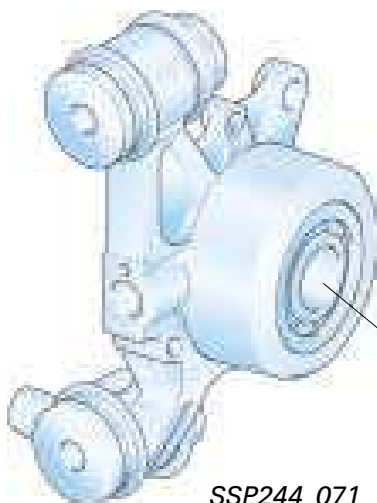

SSP244_071

Instead of the aluminium wheel bearing housing fitted on the Audi S6, use is made of a steel wheel bearing housing.



SSP244_031

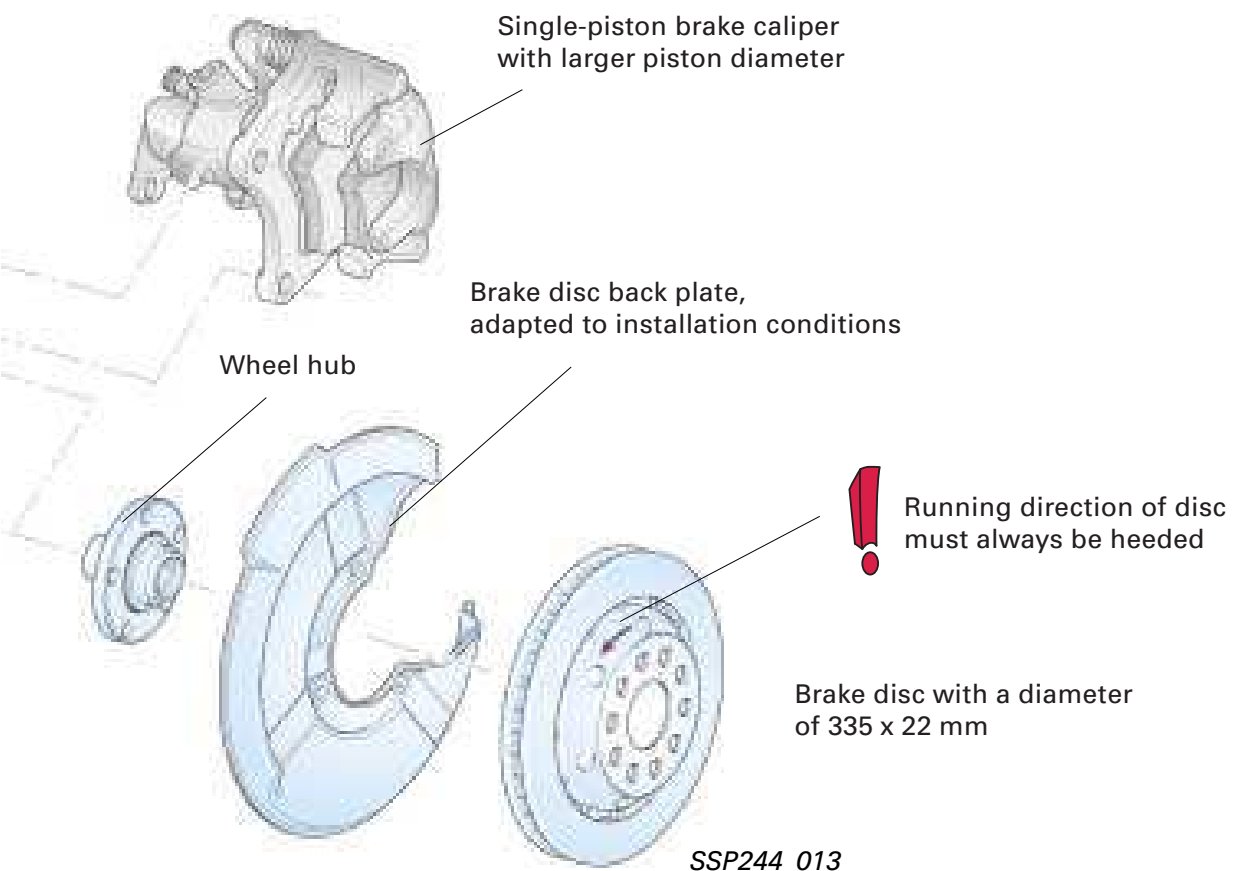

SSP244_013

Running Gear

Dynamic Ride Control – DRC

Conventional spring/damper systems can only ever offer a compromise between maximum ride comfort and a sporty driving style. The basic requirements of ride comfort, such as minimum vertical body movement when negotiating uneven surfaces and smooth rolling characteristics are diametrically opposed to those associated with the sporty properties of a vehicle, including agile handling and less side tilt with high lateral acceleration for example.

The Dynamic Ride Control in the Audi RS 6 permits a basic setting of the spring/damper assembly which is relatively soft for sporty vehicles and therefore comfortable, whilst at the same time effectively suppressing body roll and pitch when cornering, braking and driving off.

Operation of the DRC system is based on active utilisation of the volume of oil displaced by the piston rod when the damper is compressed and the resultant change in pressure in the damping system. Conventional dampers provide compensation for the volume displaced by the piston rod by employing a compressible gas cushion (single-tube gas-filled damper) or through the use of an additional chamber into which the displaced oil can expand (twin-tube damper).

The diagonal connection between the respective front and rear dampers to form two linked systems makes use of the different pressures occurring with body movement to adapt the specific damper characteristic curves to these driving conditions.



The diagonal connections between front and rear axle are geared in terms of **pipe length** and **pipe cross section** to the system as a whole (refer to colour coding in Fig. 244_025) so as to ensure reliable operation.

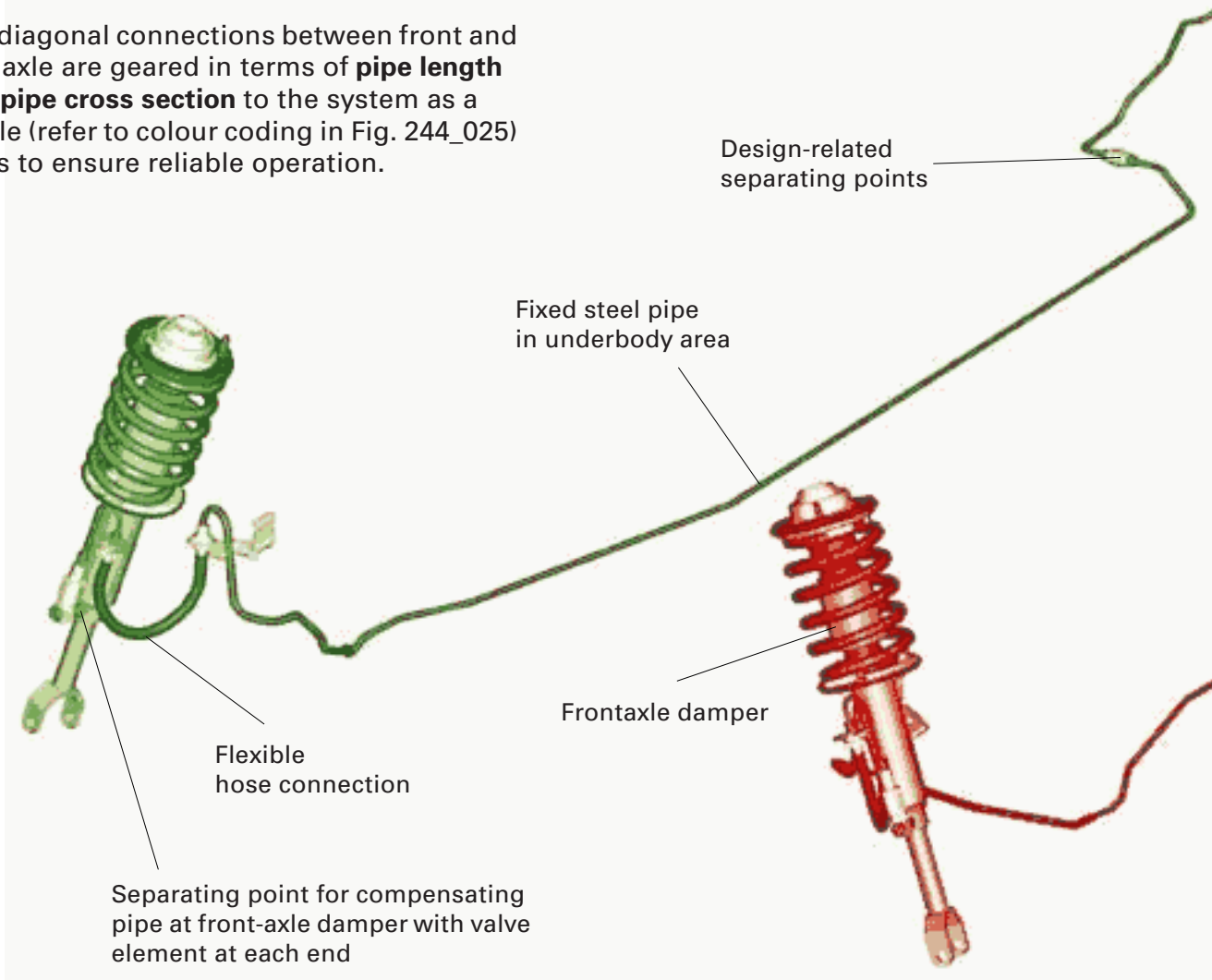

Compensation for the volumes of oil displaced is provided by one gas-filled central valve per diagonal link.

The movement of the floating piston separating the gas-filled and hydraulic sections is influenced as required by its own damper.

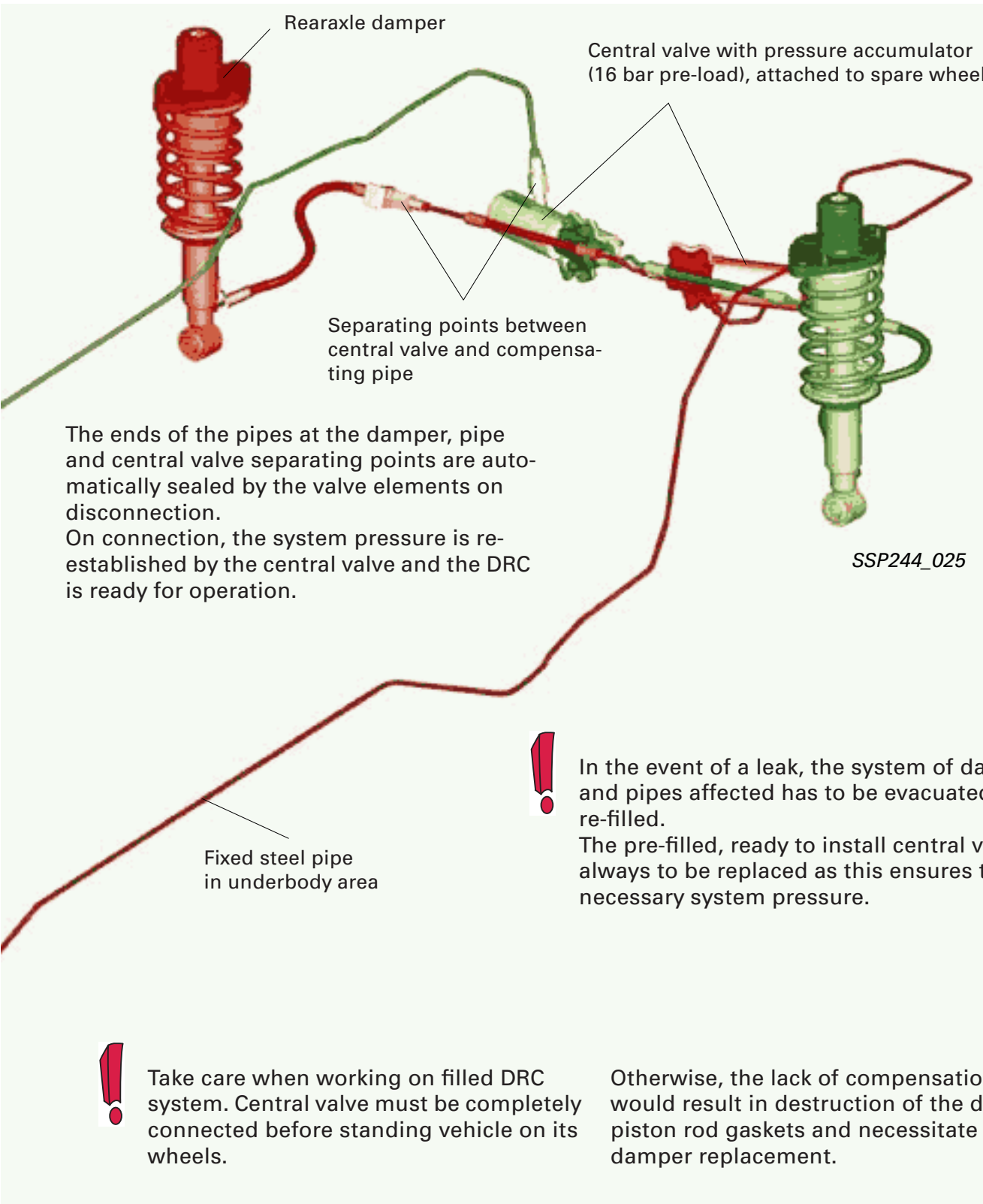

The ends of the pipes at the damper, pipe and central valve separating points are automatically sealed by the valve elements on disconnection. On connection, the system pressure is re-established by the central valve and the DRC is ready for operation.

SSP244_025



In the event of a leak, the system of dampers and pipes affected has to be evacuated and re-filled. The pre-filled, ready to install central valve is always to be replaced as this ensures the necessary system pressure.



Take care when working on filled DRC system. Central valve must be completely connected before standing vehicle on its wheels.

Otherwise, the lack of compensation would result in destruction of the damper piston rod gaskets and necessitate damper replacement.



Running Gear

Hydraulic system diagram

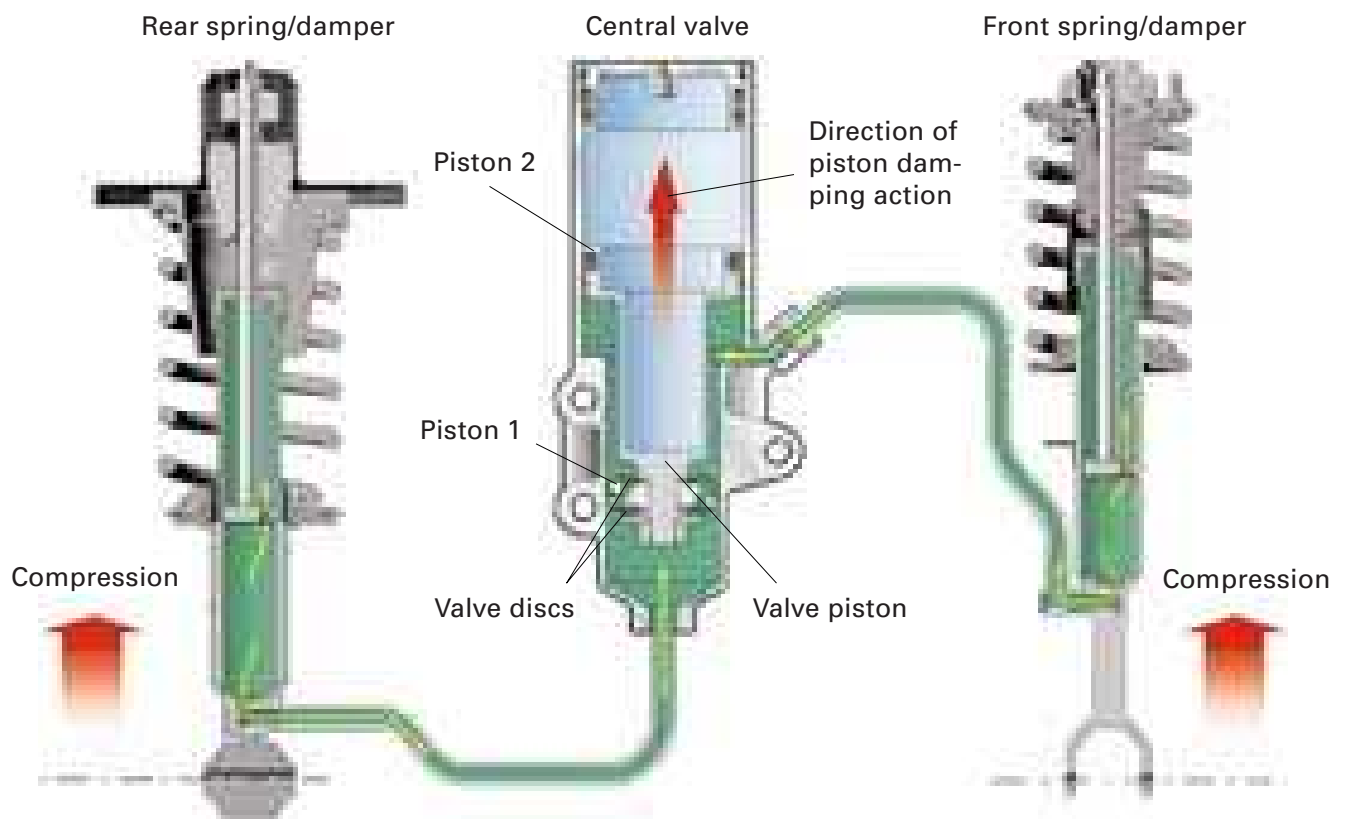

SSP244_043

Synchronous operation

If both dampers are compressed at the same time, the pressure builds up in the same direction in both pressure chambers. The active piston faces move jointly towards the gas cushion in the pressure accumulator. This results in damped compression (comfort setting) of the dampers as a function of the compression rate.

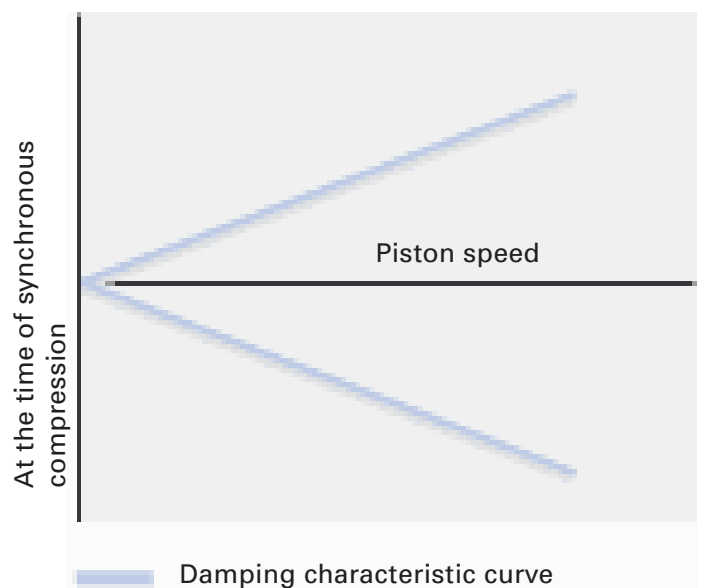

SSP244_053

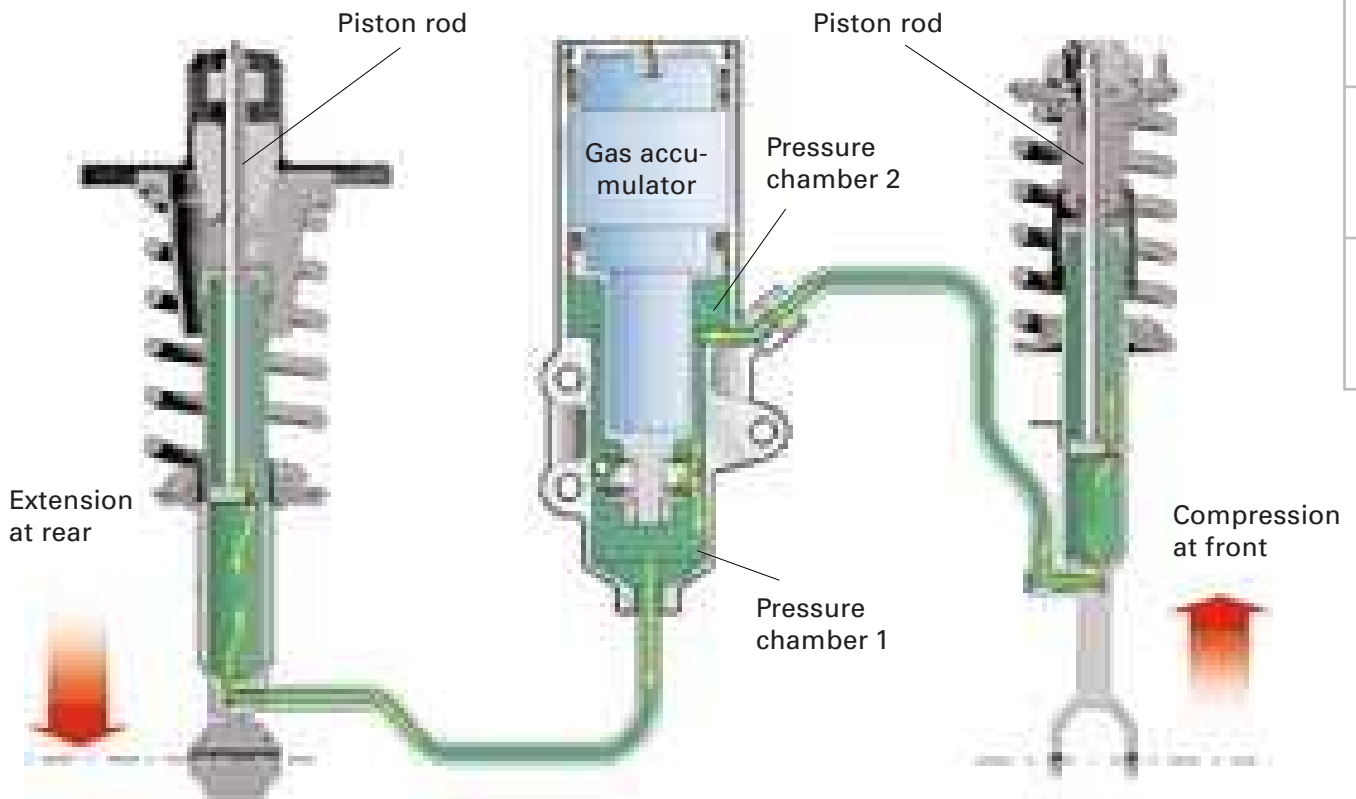

SSP244_042

Non-synchronous operation

Movement of the piston rods in different directions produces different pressure potentials in pressure chambers 1 + 2 (refer to pressure direction as indicated by yellow arrows in illustration). Piston movement towards the gas accumulator is thus not possible or only possible to a limited extent.

The necessary pressure equalisation is provided by way of the valve bores in piston 1. These are sealed on one end by thin metal discs so that flow is only possible through the holes in the piston from one side and only as of a certain threshold pressure. The setting of the dampers is thus not governed solely by the internal workings of the dampers, but also by the ratio of the surface areas, the volume displaced by the damper piston rods, the bores in the piston of the central valve and the threshold pressure applied to the piston valves.

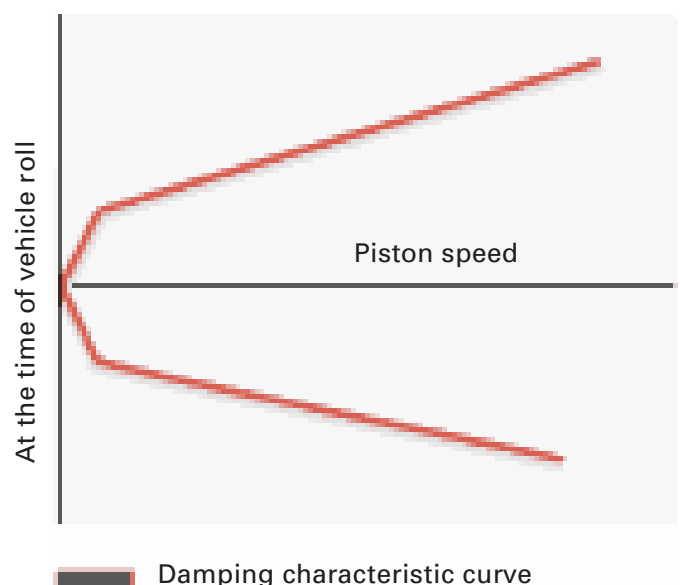

SSP244_054



Running Gear

Central valve

The pressure accumulator (gas accumulator) in the central valve is pre-loaded by the supplier to a pressure of 16 bar. The damper system oil pressures applied to pressure chambers 1 and 2 provide damped pressure equalisation in conjunction with the displacement piston.



The components are supplied pre-filled with a pressure of 16 bar. Inexpert handling could lead to injury.



SSP244_026

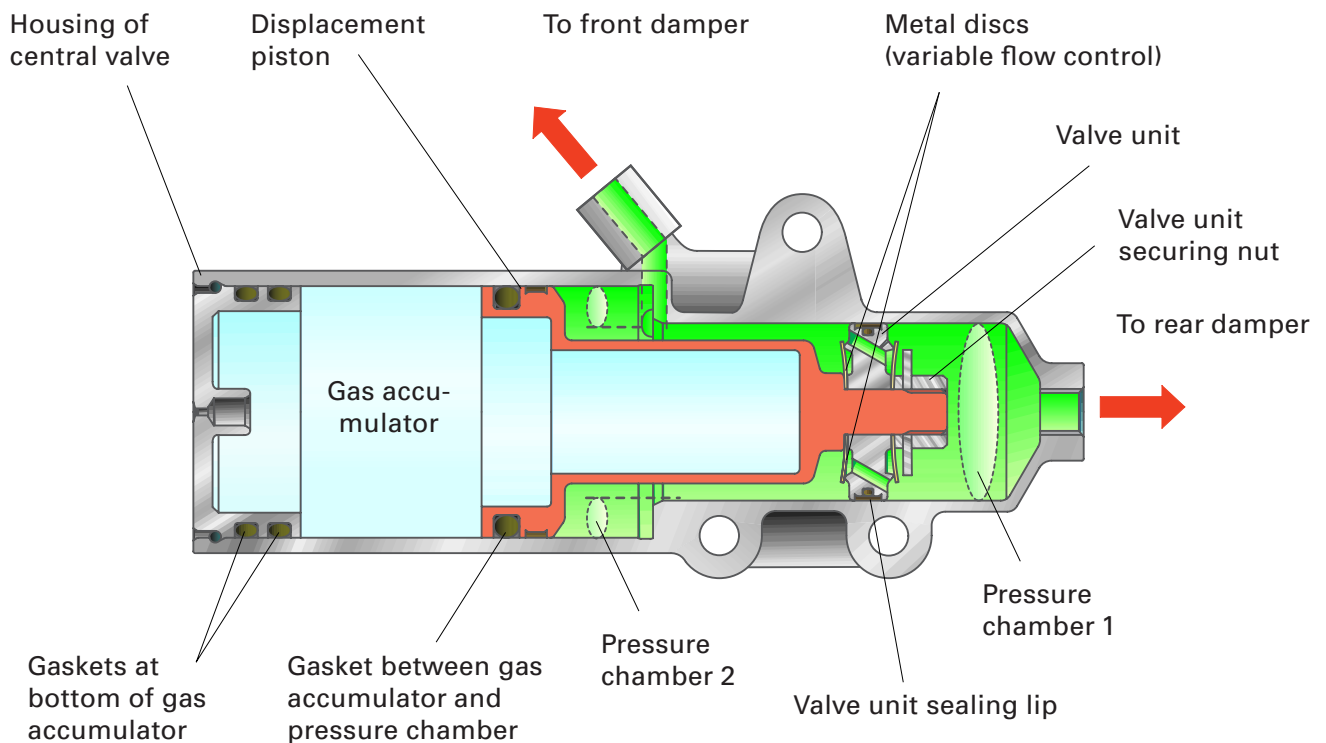

SSP244_011



The pressure zones 1 and 2 shown represent the surfaces within the central valve acting on the displacement piston.

Air conditioner

The desiccator connections have been switched from block to screw type.

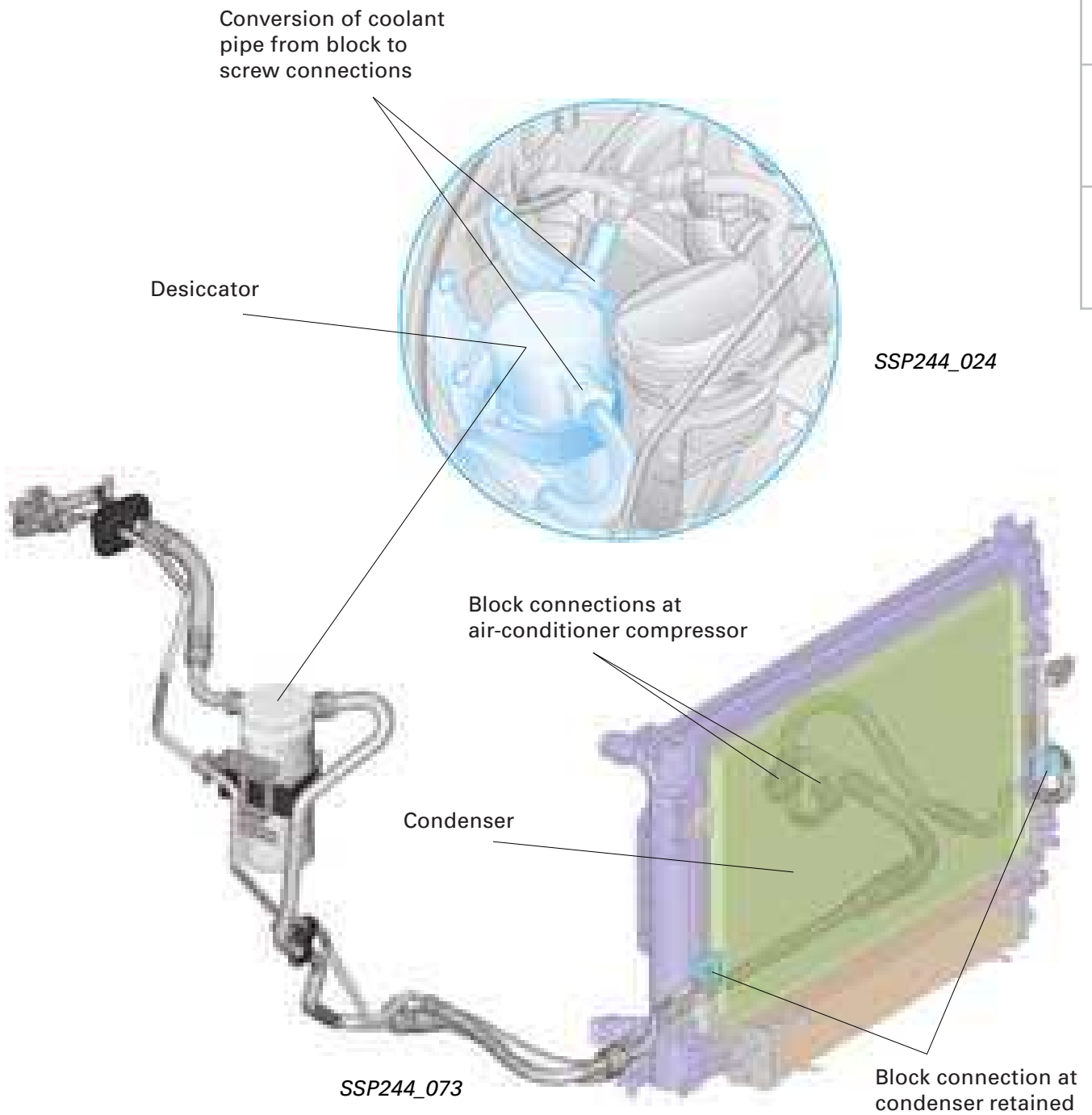

Service

Service concept

Newly designed two-part cover for luggage compartment recess for accommodating vehicle battery and tool kit (fixed in position by a central nut).



SSP244_048

The moulded holders for accommodating the tool kit, jack, towing eye and tyre repair set (Tire Mobility System) are located in a separate plastic compartment.



SSP244_049

For space reasons and to improve weight distribution, the battery was re-located to behind the rear axle in the area of the luggage compartment floor. This required modifications to the wiring harness.

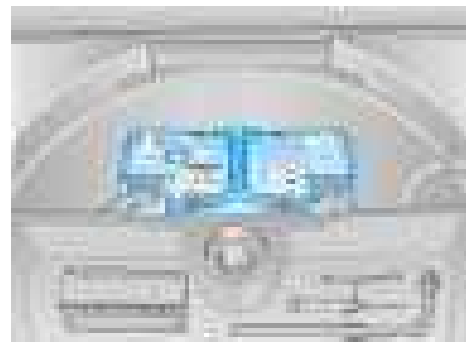

SSP244_050

Special tool

DRC tool VAS 6209

This tool is required for emptying, evacuating and filling the dampers and pipes of the DRC.



SSP244_072



Notes

Service

Technical data

Designation	Unit	4.2 bi-turbo (331 kW)	
		Saloon	Avant
Engine/electrics			
Engine code letters		BCY	
Engine design		8-cylinder 5-valve four-stroke bi-turbo petrol engine in 90° V arrangement, 2 cylinder heads, three inlet valves, two exhaust valves, sodium-cooled	
Valve timing		Two overhead camshafts per cylinder head	
No. of cylinders/valves per cylinder		8/5	
Capacity	cm ³	4172	
Bore x stroke	mm	84,5 x 93	
Compression ratio	: 1	9,8	
Max. charge pressure	bar	0,8	
Mixture formation		Motronic ME7.1.1 with charge-pressure control, electronic throttle	
Cylinder spacing	mm	90	
Idling speed	rpm	760/850 with increase	
Maximum speed	rpm	6700	
Rated power	kW (hp)/at rpm	331/450 at 5700 - 6400	
Max. torque	Nm/at rpm	560 at 1950 - 5500	560 at 1950 -5600
Engine management		Fully electronic sequential multi-point injection with 2x air-mass metering, mapcontrolled ignition with distributorless ignition system, pencil-type ignition coils and driver stages, camshaft timing control, cylinder bank-selective exhaust-gas temperature regulation, coordinated engine torque control, rapid start recognition, three knock sensors, speed sender emergency function, thermal protection and torque limitation for individual gears via charge-pressure control	
Emission control system		Two air-gap insulated shell-type exhaust manifolds, two under-bonnet metal substrate primary catalytic converters, two metal substrate main catalytic converters, with EOBD, engine-speed increase after starting (cold heating function), cylinder bank-selective Lambda probe control with four heated Lambda probes, secondary-air system	
Emission standard		EU 3	
Firing order		1 - 5 - 4 - 8 - 6 - 3 -7 - 2	
Battery	A/Ah	110	
Alternator	A max.	150 A (1740 W)	
Engine weight	kg	approx. 230	



--	--	--

Designation	Unit	4.2 bi-turbo (331 kW)	
		Saloon	Avant
Transmission			
Drive system		quattro® permanent four-wheel drive, automatic locking Torsen centre differential, electronic differential lock EDL by way of brake application at all driven wheels	
Type of gearbox		5-speed tiptronic® with dynamic shift programme DSP	
Gearbox code letters		GAG	
Running gear/steering/brakes			
Front axle		RS 6 sports running gear with DRC (Dynamic Ride Control) Roll compensation	
Rear axle		RS 6 sports running gear with DRC (Dynamic Ride Control) Roll compensation	
Steering		Power-assisted maintenance-free rack and pinion steering	
Overall steering ratio		16,2	
Turning circle	m	11,4	
Front/rear brake system		Dual-circuit diagonal brake system, ventilated front/rear disc brakes, with 8-piston high-performance brakes at front, anti-lock brakes ABS with electronic brake pressure distribution EBPD, electronic differential lock EDL, traction control system TCS, electronic stability program ESP	
Front/rear brake diameter	mm	365 x 34 / 335 x 22	
Wheels		Light alloy wheels 8.5 J x 18 RO 30 in 9-spoke design Light alloy wheels 9 J x 19 RO 35 in 5-arm design	
Winter wheels		Light alloy wheels in 5-arm design, 7.5J x 18 with 225/45R 18 tyres, suitable for snow chain	
Tyre size		255/40 R 18 99Y E. L. (= Extra Load) 255/35 R 19 96Y E. L.	

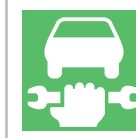

Service

Designation	Unit	4.2 bi-turbo (331 kW)	
		Saloon	Avant
Body/dimensions			
Type of body		Integral, fully galvanised, front and rear steel deformation zones, 4 doors with additional side protection	
No. of doors/seats		4/5	5/5
Frontal area A	m ²	2,2	2,2
Drag coefficient c _d		0,34	0,35
Overall length	mm	4858	4852
Width not including mirrors	mm	1850	1850
Width including mirrors	mm	1932	1932
Vehicle height*	mm	1387 (unladen) ... 1426 (laden)	1390 (unladen) ... 1430 (laden)
Wheelbase	mm	2759 (unladen) ... 2762 (laden)	2759 (unladen) ... 2762 (laden)
Front/rear track	mm	1578...1588/1587...1597	1578...1588/1587...1597
Luggage compartment sill height	mm	560...624	510...574
Luggage compartment volume	l	424	455/1590
Weights			
Kerb weight (ready for use)**	kg	1840	1880
Gross weight	kg	2380	2420
Front/rear weight distribution	kg	1260/1175	1260/1200
Permissible front/rear axle load	kg	1255/1160	1255/1200
Permissible roof load	kg	100	100
Payload	kg	540	540



* Vehicle height depends on tyres.

** Retrofitting of accessories increases kerb weight.

Designation	Unit	4.2 bi-turbo (331 kW)	
		Saloon	Avant
Capacities			
Engine coolant		VW G12	
Cooling system capacity (incl. heating)	l	11	
Engine oil capacity (incl. filter)	l	9 (fresh fill); 7.5 (oil change)	
Engine oil grade	l	Audi - 5W40 and VW 50501	
Tank capacity	l	82	
Washer fluid reservoir with headlight washer system	l	4,7	
Performance/consumption/acoustics			
Maximum speed	km/h	250 (regulated)	
Acceleration			
0 ... 100 km/h	s	4,9	
0 ... 200 km/h	s	17,6	17,8
Type of fuel		Unleaded 98 RON as per DIN EN 228 Unleaded 95 RON as per DIN EN 228 permitted by knock control	
Consumption as per 93/116/EG***			
Urban	l/100 km	21,8	
Non-urban	l/100 km	10,4	
Total as per MVEG	l/100 km	14,6	
CO ₂ emissions	g/km	350	
Theoretical range	km	561	
Stationary/driving noise Const. pass-by	dB(A)	89/74	
Maintenance/warranty (Germany)			
Oil change interval	km	Service interval display	
Inspection interval	km	LongLife Service in line with service display; depending on driving style and usage conditions, mileages of up to 30,000 km are possible between service intervals; maximum service time intervals must not exceed 2 years	
Warranty Vehicle/paintwork/body	Years	2/3/12	

*** Driving style, road/traffic conditions, ambient influences, vehicle condition and vehicle equipment may in practice lead to consumption values differing from those determined in line with this standard.



Notes

